

# ANNUAL REPORT

## 2016-2017



प्लाज़्मा अनुसंधान संस्थान

Institute for **Plasma Research**

Bhat, Gandhinagar 382428

## GOVERNING COUNCIL

- |                               |                      |
|-------------------------------|----------------------|
| 1) Shri Sekhar Basu           | Chairman             |
| 2) Joint Secretary (R&D), DAE | Member               |
| 3) Shri R.A. Rajeev           | Member               |
| 4) Dr. S. Chaturvedi          | Member               |
| 5) Dr. Siraj Hasan            | Member               |
| 6) Dr. Amit Roy               | Member               |
| 7) Shri K.N. Vyas             | Member               |
| 8) Dr. J. N. Goswami          | Member               |
| 9) Shri Sanjay Lal Bhai       | Member               |
| 10) Smt. Anju Sharma          | Member               |
| 11) Shri P. K. Atrey          | Non-Member Secretary |

## EXECUTIVE SUMMARY

During the year (2016-17), the Institute continued its activities in Fusion research, Technology development, Industrial and Societal applications and Experimental & theoretical investigations of fundamental plasma physics, apart from deliveries to the ITER project.

Some achievements and key developments are enumerated below:

1. Recommissioning of the Aditya tokamak with a set of external coils and internal graphite tiles for shaped plasma experiments is one key achievement. Operation on the device was resumed in December 2016 and plasma current of 80-95 kilo Amperes extending up to 180 milliseconds has been achieved.
2. Renewed efforts have been put on resolving the issues with SST-1 Magnet systems. A series of diagnostics experiments have been carried out and revision of the liquid Helium distribution and feeder systems is being considered.
3. Several other smaller experiments too produced significant research results. The LVPD system experimented with energetic electron loss process in atmospheric plasma with a new rectangular cathode. The Microwave Plasma experiment (SYMPLE) integrated a 3MW, 3GHz, 5 micro-Seconds pulsed modulator and conducted long term confinement experiments. Plasma Torch experiment demonstrated a high of 85kW power, a new probe capable of withstanding the high temperature was also developed.
4. An Inertial Electrostatic Confinement Fusion device produced neutron dose rate of 13-27  $\mu\text{Sv/hr}$  in an input voltage range of 40-60kV. Further characterization is in progress. In an Magnetised Plasma Experiment for Plasma Surface Interaction experiment 200kW operation at axial field of 0.45Tesla achieved  $10^{20}\text{m}^{-3}$  density.
5. Coating with 500 micron pure Tungsten material on Steel was achieved for 50mm x 30mm surface area (collaborator - ARCI (Hyderabad) and tested for integrity over 1000 - 5000 Cycles range.
6. While the TBM activity is entering Engineering Design Phase and neutron estimation database is being generated, mock-up of a TBM first wall module was complete to qualify the fabrication processes (HIP) and materials (Indian RAFM), etc.
7. Development of a helium gas purifier and cryogenic plate-fin heat exchanger for operation with He are underway as a part of large cryo plant development.
8. A 25kg Payload articulated arm has been manufactured and undergoing tests as a part of the development of reactor remote handling equipment. A gripper assembly of 1kg capacity is also in progress. A low cost Virtual Reality Integrated Development laboratory has been commissioned; this is going to help review of design of complex machines.

9. Beam extraction of  $27\text{mA}/\text{cm}^2$  with low ( $<1$ ) electron to ion ratio has been achieved in the negative ion based Neutral Beam experiment, the source uses RF plasma with Caesium injection to produce negative ions of Hydrogen.
10. A 3-D molecular dynamics code has been developed for studies of ionised cluster with electrons relevant in laser plasma interactions. Design studies relevant to structural and nuclear design of future tokamaks.

In Industrial and Societal applications, the FCIPT division have initiated trials on several innovative areas of applications:

- Trials in biological applications of plasma
- Plasma jet based fungal treatment experiments are ongoing in collaboration with PG medical college, Kolkata.
- Use of another type of plasma jet for treatment of Lung Cancer Cell is being explored in collaboration with BARC.
- Hip implant balls have been plasma coated with Titanium Nitride in collaboration with CGCRI, Kolkata.
- Microbial properties of Plasma Activated Water are being studied in collaboration with Gujarat Environment Management Institute and initial results are promising.
- Oxygen barrier coating of plastics for food packaging
- Application of a 2.5m wide atmospheric plasma column to treat man-made Textile in collaboration with MANTRA, Gandhinagar.
- Study of growth of nodular corrosion in pressure tubes of NPCIL's PHWRs using an atmospheric pressure  $\text{CO}_2$  plasma.
- Plasma based Nano-material production with excellent control on size may have potential application in pharmaceutical industry.
- A Plasma Pyrolysis based waste disposal system of  $150\text{kg}/\text{day}$  has been installed by an industrial collaborator at the GIFT city, Gandhinagar.

The Institute has also initiated use of another core competence area, viz., computer software development in application areas. Two initiatives are showing good potential in their initial trials.

Development of a deep learning software for automatic detection of lung nodules in chest X-Rays in collaboration with TMC, Mumbai. An image processing tool to identify regions of protein collocation in biological cells for Molecular Biology Division of BARC.

ITER India made substantial progress in deliveries and R&D in preparation to ITER supplies.

- Indian In-wall Shield blocks were delivered for 2 sectors of the vacuum vessel.
- The Cryostat base section and lower tier cylinder, involving fabrication of some 1500 tons

of steel reached the site workshop at ITER and final site assembly has begun.

- Large part of the Cooling Water System comprising of various pipe works, large heat exchangers, pressurisers, etc, have been shipped to ITER site.
- After successful test of prototype cryolines at the laboratory in campus, production has started at different places in India and abroad.
- The R&D for ICRF system achieved the full 1.5MW, 2000 Seconds operation (with matched and mismatched loads) in the campus laboratory.
- A cryopump module for use by the DNB system was developed and is undergoing tests.
- A 100kV HV Power Supply was delivered to the Neutral beam Test facility in Italy apart from commissioning and characterization of similar unit in the campus laboratory.
- A Fast Scanning Fourier Transform Spectrometer has been received and final assembly in progress at laboratory.

Academic programs like Summer School (46 students), Technical Training and Doctoral programs (42 students) of the institute were continued as usual. The institute had 217 publications in peer reviewed journals apart from 88 Research Reports and 48 Technical Reports published during the year.

DIRECTOR,  
IPR.

# *ANNUAL REPORT*

**APRIL 2016 TO MARCH 2017**

*Since 1986 the institute has been involved in plasma physics research with fast growing facilities, trained man power and many fruitful national and international collaborations. Starting with small tokamak experiments and basic plasma experiments, the institute has been acquiring expertise in most of the relevant scientific and technological requirements for controlled thermonuclear fusion. Through the participation of the country in the ITER project, technologies related to fusion are being developed in the institute which are also being tested in the international arena. Also the technologies thus developed are being made available and being applied to many other societal problems benefiting the country.*

## **CHAPTERS**

A. SUMMARY OF SCIENTIFIC & TECHNICAL PROGRAMME .....	01
B. ACTIVITIES OF ITER-India .....	30
C. ACADEMIC PROGRAMME .....	37
D. TECHNICAL SERVICES .....	37
E. PUBLICATIONS AND PRESENTATIONS .....	39



## *CHAPTER A*

# SUMMARY OF SCIENTIFIC & TECHNOLOGICAL PROGRAMMES

A.1 Fundamental Plasma Physics.....	02
A.2 Technology Developments.....	13
A.3 Societal Benefits of Technology.....	22
A.4 Theoretical, Modelling & Computational Plasma Physics....	25

## A.1 Fundamental Plasma Physics

The fourth state of matter, Plasma, after solid, liquid and gas is being studied in various conditions so as to explore applications for the humankind. Here it is being studied in very small scale laboratory experiments as well as in slightly bigger scale in tokamak configurations.

### A.1.1 Basic Experiments

<i>Basic Experiments in Toroidal assembly</i> .....	02
<i>Large Volume Plasma Device</i> .....	02
<i>SYstem for Microwave PLasma Experiments (SYMPLE)</i> .....	05
<i>Non-Neutral Plasma Experiments</i> .....	05
<i>Plasma Torch Activities</i> .....	06
<i>Interaction of Low Energy Ion and Neutral Beams with Surfaces</i> .....	06
<i>Multi-Cusp Plasma Device</i> .....	06
<i>Inertial Electrostatic Confinement Fusion (IECF) Device</i> .....	06
<i>Studies on Negative Ion Source</i> .....	07
<i>Ion-Ion Plasma Experiments in a Helicon Source</i> .....	07
<i>CPP-IPR Magnetized Plasma Experiment for Plasma Surface Interaction (CIMPLE-PSI)</i> .....	08

<b>A.1.2 Aditya Tokamak</b> .....	08
-----------------------------------	----

<b>A.1.3 Steadystate Superconducting Tokamak</b> .....	10
--	----

### A.1.1 Basic Experiments

#### *Basic Experiments in Toroidal Assembly (BETA)*

In a simple toroidal device such as BETA, the plasma profiles and properties depend on toroidal magnetic field topology. For example, the toroidal connection length crucially controls the adiabatic or the non-adiabatic nature of electron dynamics, which in turn governs the nature of instabilities, fluctuations, and transport, the latter of which governs the plasma mean profiles. Recently, extensive experiments were performed in BETA by controlling the mean parallel connection length  $L_c$ , by application of external vertical component of magnetic field  $B_v$ , where  $B_v$  is of the order of 2% of toroidal magnetic field  $B_T$ . Interestingly, for nearly closed field lines, which are characterized by large values of  $L_c$ , it is found that flute like coherent modes are observed to be dominant and is accompanied by large poloidal flows. For small values of  $L_c$ , the mean density on the high field side is seen to increase and the net poloidal flow reduces while a turbulent broad band in fluctuation spectrum is observed.

Upon a gradual variation of  $L_c$  from large to small values, continuous changes in mean plasma potential and density profiles, fluctuation, and poloidal flows demonstrate that in BETA there exists a strong relationship between  $L_c$ , flows, and fluctuations. The net flow measured is found independent of the direction of  $B_v$ , but an asymmetry in the magnitude of the flow is found. The observed imbalance between the mean flow, fluctuation driven flow and net flow is still unexplained. Lastly, extensive experiments varying both  $B_T$  and  $B_v$  but keeping certain ratio values to be constant, has been performed. A manuscript is under preparation. Presently work is underway to measure particle confinement time experimentally as well mass scaling studies.

#### *Large Volume Plasma Device (LVPD)*

LVPD has progressed primarily on three major fronts, namely, i) experimental investigations for a) understanding plasma transport due to Electron Temperature Gradient (ETG) turbulence, having relevance to plasma loss in fusion devices and b) understanding physical mechanism involved for the loss of energetic electrons present in LVPD plasma, ii) continuing

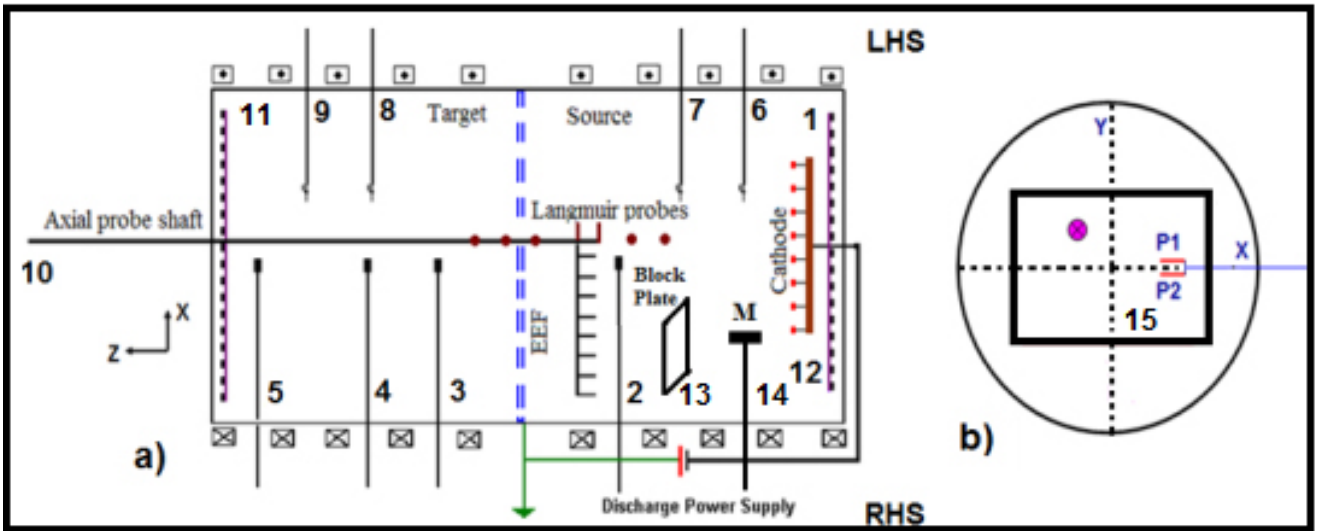

Figure A.1.1 Schematic a) LVPD experimental system and b) cross-section view of rectangular source function.

efforts to complete automation of the device and iii) development of diagnostics.

**(i) Experimental Investigations**

**(a) Turbulent Particle transport in Electron Temperature**

*Gradient (ETG) Turbulence Background:* Turbulent transport is a ubiquitous phenomenon prevalent in laboratory, space and astrophysical systems. Figure A.1.1: Schematic showing a) LVPD experimental system and b) cross-section view showing rectangular source function. ETG turbulence has

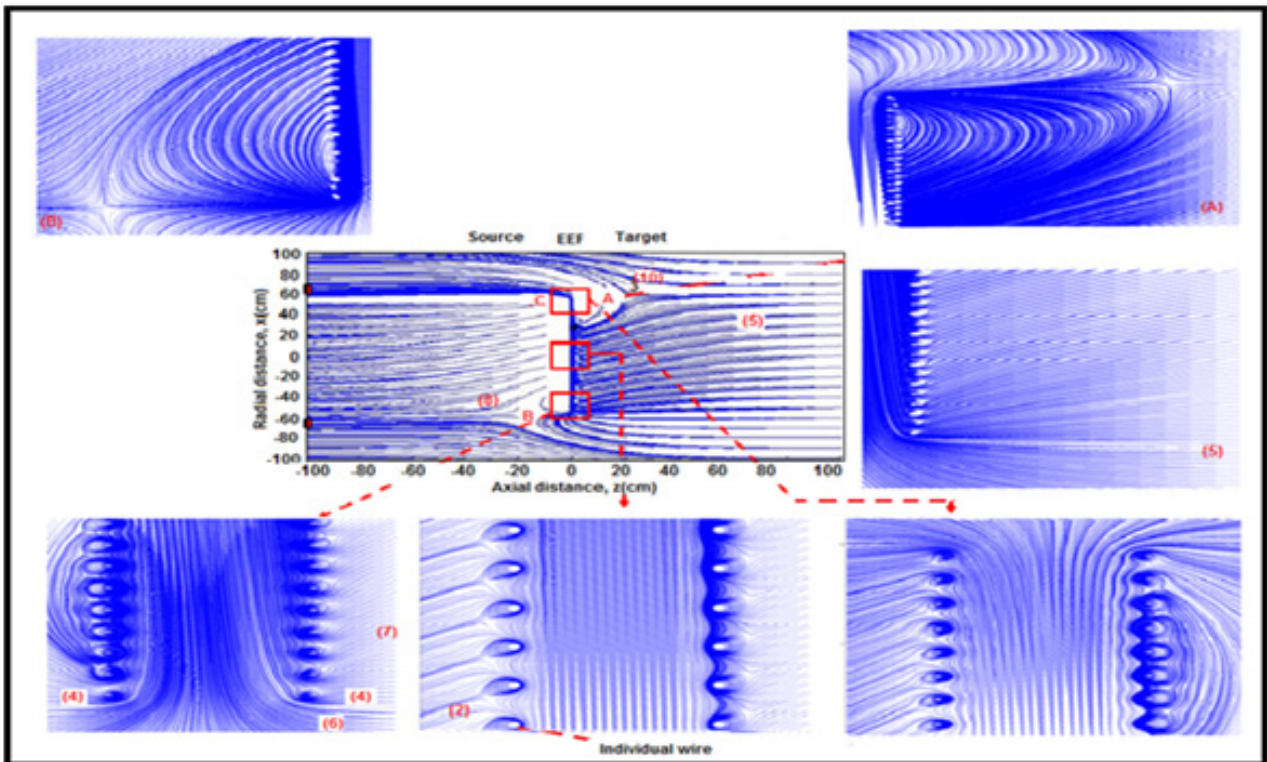

Figure A.1.2 Shows simulated coupled magnetic field of the EEF solenoid with uniform ambient magnetic field

been successfully established turbulence in target plasma of LVPD and brought its scales in measurement limits of conventional diagnostic tools. The source of the underlying turbulence has been established as electron temperature gradient driven modes in the core of the target region of the device. This is ensured by making the target region free of energetic electrons by using a transverse magnetic field with the help of an Electron Energy Filter [see figure A.1.1]. The phase velocity, correlation between density and potential fluctuations and turbulence power spectra confirms that the observed turbulence in LVPD is driven by ETG.

*(b) Understanding Physical Processes Involved in Energetic Electron Loss:* Energetic electrons are produced in large numbers in LVPD because of direct acceleration of emitted electrons from the filamentary source. The transverse magnetic field of EEF ( $B_x = 150\text{G}$ ) modifies the ambient magnetic field ( $B_z = 6.2\text{G}$ ) in the near vicinity of EEF. Figure A.1.2 shows the simulated coupled magnetic field of EEF. Magnetic field of EEF has led to formation of the magnetic mirrors. In the source plasma region, we have measured excess floating potential (mimics presence of energetic electrons) values in the plane at different axial locations in source plasma side. It seems then most energetic electrons emitted from the filaments are lost in the EEF while causing ionization in the source region and excitation of neutrals. It is found that only energetic electrons in the left half side are reflected back from the magnetic mirror to the source plasma and these electrons should have velocity distribution with loss cone features. It is found that the polarization angle obtained from the phase difference at various frequencies of the fluctuating signals is not circularly polarized. It is inferred here that the polarization might be elliptical. According to the cold plasma approximations, this could be due to the whistler waves of frequency  $10\text{kHz}-70\text{kHz}$  propagate at highly oblique angles ( $\theta = 89$  degrees) for LVPD device and plasma parameters. Such Whistler waves can be described by Quasi Longitudinal (QL) approximation. These observations in LVPD source plasma can have similarities to QL excited when the interplanetary magnetic field near the magneto pause turns southwards, it triggers reconnection events which release the energetic electrons emanating out from solar flares and travelling with the solar wind into the earth's magnetosphere. The pole bound electron flux gets trapped in the earth's magnetic field and suffers loss cone instability generating the observed QL whistlers.

(ii) *Complete Machine Automation:* In continuation to augmentation of 40 channels PXI based data acquisition system



Figure A.1.3 Magnetron system, integrated with the pulsed modulator and the HPM coupling components.

on LabVIEW graphical development platform, the software has been enhanced to adapt object - oriented software engineering principle and architecture. The process automation software of MCS has been enhanced for advanced capabilities. The process automation software presently covers high current filament power supply ( $10\text{ kA}/20\text{V}$ ) and 12 numbers of probe positioning systems (stepper motor and drive based linear positioning system (travel length  $\sim 100\text{ cm}$ )) connected on 4-wire RS485 and interfaced using standard Modbus communication protocol. The software has been enhanced to cov-

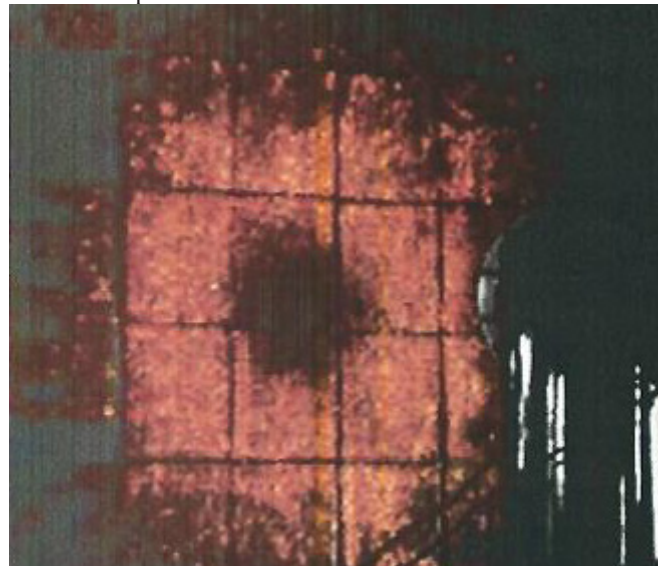

Figure A.1.4 The Neon bulb glow pattern establishing the HPM output from BWO in the TM mode.

er the simultaneous positioning of 12 probes from sequential positioning in the horizontal plane of the machine.

(iii) *Diagnostics Development*: This development work for turbulent energy flux measurements has been undertaken. This requires real time sampling of temperature and poloidal velocity fluctuations. The triple probe developed for pulsed plasma investigations is calibrated for temperature measurements using single and double probe diagnostics. Final work on delivering it as a diagnostic tool for energy flux measurements is in progress and soon real time measurements of energy flux will be undertaken using this diagnostics.

**System for Microwave PLasma Experiments (SYMPLE)**

A pulsed modulator with 3 MW, 3GHz, pulsed (5 micro-second) Magnetron has been integrated with the driver and the coupling components (circulator, variable attenuator, directional coupler, dummy load, tuner etc.). The system, as shown in the figure A.1.3, has been tested successfully for the desired pulsed modulator output (50 kV, 100 kA) and the High Power Microwave output. The Backward Wave Oscillator being developed at BARC as a combined effort by IPR and BARC, has been tested for the HPM output characteristics. The BWO tube, when integrated with the KALI

– pulsed power driver, delivered about 500 MW HPM power. Figure A.1.4 shows the neon bulb glow pattern that ensured attainment of HPM power in the TM mode.

**Non-Neutral Plasma Experiments**

*Design and Developmental tasks*: Trap components and inner bore have been redesigned, fabricated and installed to probe the plasma better and accommodate thick conductors for TF. Inner surface of the vessel has been polished thoroughly for better, free from outgassing and sustainable vacuum. The pumping line has been placed on a newly designed and fabricated support structure for stability and ruggedness. TF coil has been upgraded to cause a toroidal magnetic induction of 1.2 kilogauss for the time duration of about 3 seconds. Protection circuits for data acquisition and control system have been developed and tested. A query based database management system has been developed for the detailed analysis of experimental data and currently going through rigorous tests. A test plasma has been made and diocotron oscillations have been observed post vessel conditioning and installation of improved trap components.

*Experiments*: Long-time confinement experiments have been performed. The electron plasma in the system approaches

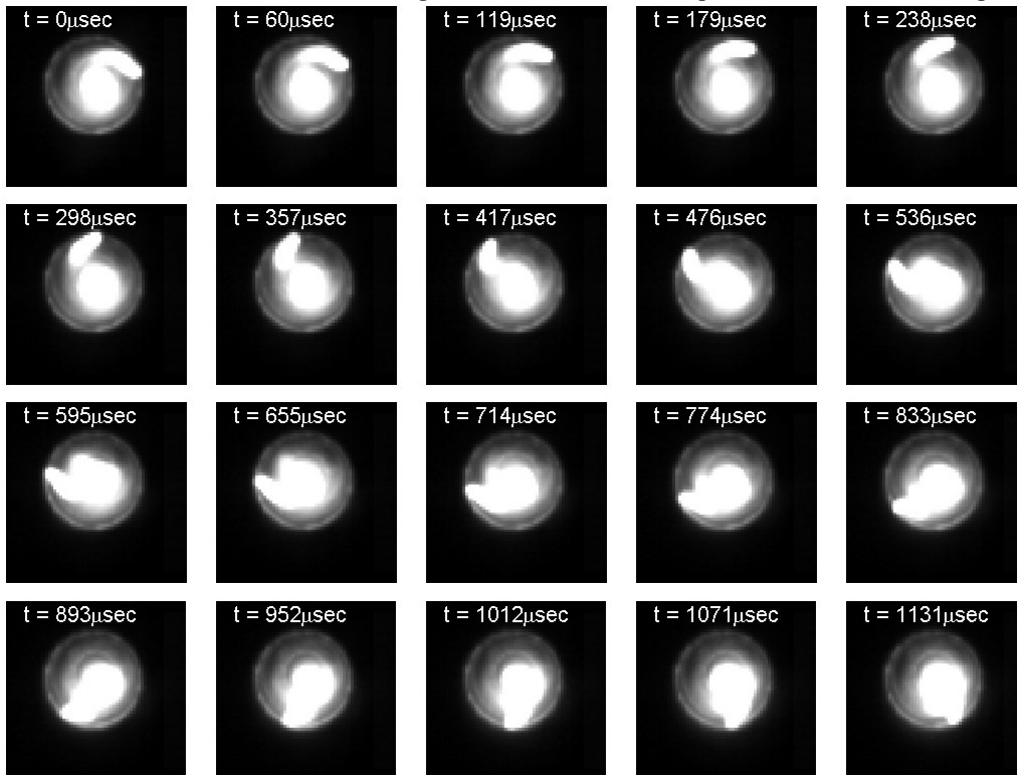

*Figure A.1.5 End-on images showing rotation of the nitrogen plasma column in an atmospheric pressure dc non-transferred plasma torch captured using fast camera in the presence of external magnetic field*

magnetic pumping transport. Attempts have been made to obtain radial shift of electron charge cloud from ratio of two capacitive probe signals based on shape identifying algorithm.

### Plasma Torch Activities

Steady-state operation of plasma torch was demonstrated at 85 kW. A novel enthalpy probe was developed that eliminates the possibility of welding/brazing joints facing the plasma plume and can withstand higher plasma temperatures. Plasma torch computer model was successfully run on the high performance cluster machine. The model was upgraded to include more realistic boundary conditions and role of metallic vapour in the plasma. Results were shown to match with experiments to a great extent. Fundamental studies involved the investigation of dynamical behaviour of the plasma using fast imaging techniques [see Figure A.1.5] where the role of external magnetic field, discharge current and gas flow on the arc dynamics were delineated. In another experiment, the role of fluid dynamic configurations on the plasma torch efficiency was also investigated.

### Interaction of Low Energy Ion and Neutral Beams with Surfaces

An experimental setup exists for studying interaction of low energy ions with metal surfaces which utilizes high density plasma beam ( $10^{13} \text{ cm}^{-3}$ ) of 26 mm diameter. The plasma is generated with the help of 800W pulsed microwaves (frequency = 100 Hz, duty cycle = 10%) and 800 Gauss magnetic field produced by a pair of electromagnets (Helmholtz coils). This above plasma source was built with the dual purpose of studying not only interaction of high density plasma but also neutral beam with metal surfaces. To generate a neutral beam a reflection plate is placed in the path of the plasma beam at  $45^\circ$  to its axis. To image the neutral beam a micro channel plate (MCP) / phosphor screen based low energy (1-100eV) neutral beam observation system has been procured. This observation system can only function in the pressure domain which is lower than  $5 \times 10^{-6}$  mbar. Hence differential pumping mechanism is needed to keep the pressure in this domain while the pressure in the main plasma source is about 400 times higher. The ultra-high vacuum (UHV) chamber which will house the neutral beam observation system and which utilizes turbo and dry scroll pumps has already been fabricated and tested for ultimate pressure ( $6 \times 10^{-8}$  mbar) and also for the differential pumping mechanism. Presently we are in the process of assembling the neutral beam observation system in the UHV chamber. In the near future we will not only image the neutral beam but also detect it with the help of an ionizer cum mass spectrometer as well as determine flux by adding an energy analyser.

### Multi-Cusp Plasma Device

A new design for the ionizer plate is being explored while the design for the caesium oven is being revisited through the various experiences gained through the caesium material used in the negative ion source experiments. The Argon plasma produced by filamentary sources have established a very quiescent nature for about a radial distance of 6 cm from the axis, while different fluctuations have been recorded beyond 6 cm. Though the gradient is there in the axial direction, it is found to be very small compared to the gradient length in the radial direction, at the midplane perpendicular to the axis of the main chamber. The fluctuations are being studied in detail with the variations with respect to the magnetic field gradients and different field values. Reports are being generated for publications from these works.

### Inertial Electrostatic Confinement Fusion (IECF) Device

A cylindrical IECF chamber has been installed at CPP-IPR. By making use of hot or cold cathode discharges the deuterium plasma is being produced in it (Figure A.1.6). Fusion neutrons are emanated from the device on applying voltage of above 20 kV to the deuterium plasma. The high voltage is applied to the central grid of IECF device using the HVPS (200 kV, 80 mA). The experiments are conducted to check

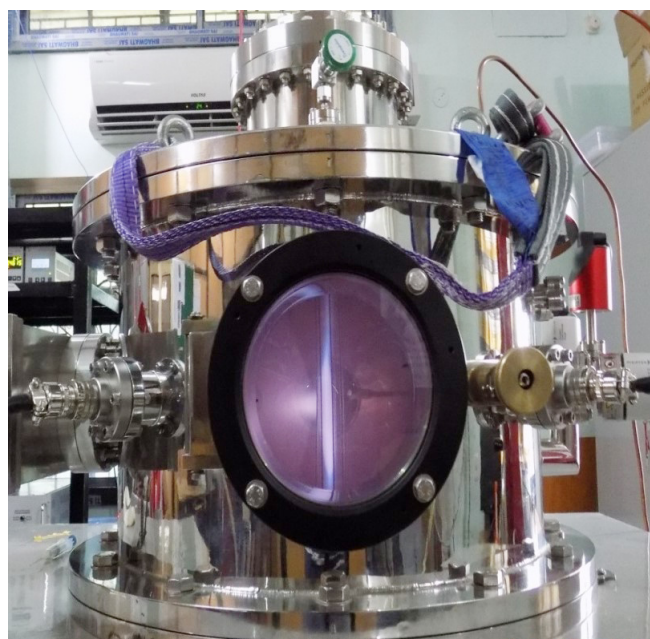
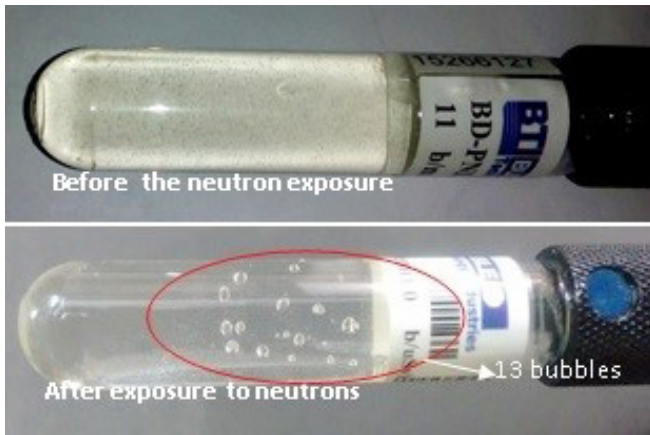

Figure A.1.6 Inertial Electrostatic Confinement Fusion (IECF) device showing glow discharge plasma



*Figure A.1.7 Detection of neutrons from IECF device using bubble detector*

the neutron emission from IECF device using neutron area monitor. The detector in area monitor is basically a He-3 proportional embedded with polyethylene and boron plastic as moderator. The neutron area monitor was kept at a distance of 1.5 m from the IECF chamber. A dose rate of about 8.861  $\mu\text{Sv/hr}$  have been observed. This was also confirmed by using a bubble detector (BD-PND) which recorded 13 bubbles corresponding to neutron dose of 13  $\mu\text{Sv}$  for a voltage of 40 kV for about 10 s. On further increasing the voltage to 60 kV, a maximum neutron dose rate of 27  $\mu\text{Sv/hr}$  was also obtained.

### Studies on Negative Ion Source

In a typical voluminous negative ion source, one needs a plasma with very low temperature around 1 eV without any other energetic electrons. It is because the negative ions are produced by attachment of low energy electrons to a neutral hydrogen atom. This type of low temperature plasma is typically made by using magnetic filtering from the plasma produced using filaments where the high energetic electrons are stopped by the filter. The filtering process is influenced by many processes which need to be understood. An experimental device has been built to study these influential phenomena.

*Influence on cross-field diffusion by effecting the diamagnetic drift of the charged particles:* The experimental setup consists of two identical multi-cusp magnetic cages of 0.32 m in length and 0.25 m in diameter each for source and target regions. Magnet channels (N-S) are kept separated from each other to form a transverse magnetic field (TMF). Five tungsten filaments are used in the source region to produce Hydrogen plasma at a working pressure of  $\sim 5 \times 10^{-4}$  mbar,

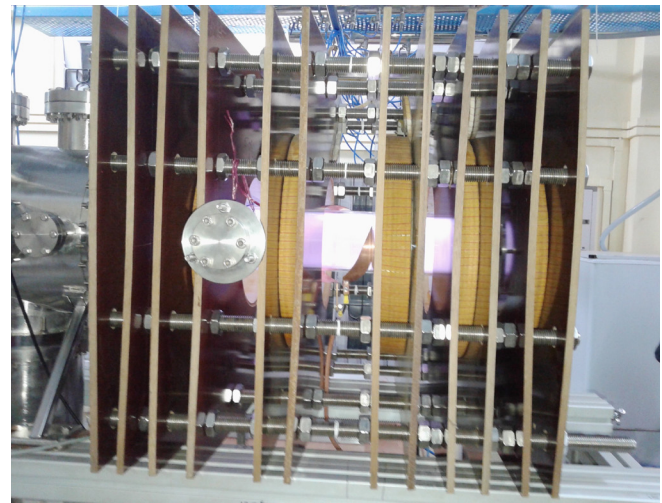

*Figure A.1.8 Argon plasma produced in the HeliPS system*

at a discharge voltage = 80 V. Two stainless steel plates (P1 and P2) are biased up to 80 V. The electric field between the plates, in one configuration, restricts whereas, in the opposite configuration, facilitates charged particle movement from source to target region. It is found that diffusion of plasma across a magnetic filter can be varied by influencing the diamagnetic drift.

*Measurement of negative ion density using laser photo-detachment signal:* The negative ion density is measured using the laser (Nd YAG, 1064 nm  $\sim$  70 mJ) photo-detachment setup. The laser beam is reflected by multiple mirrors to make it incident inside the target region just opposite the Langmuir probe tip which is kept biased. The photo detachment signal is then collected in an oscilloscope. Initial experiments and analysis of oscilloscope signals show negative ion density of  $\sim 3 \times 10^{13} \text{ m}^{-3}$  in the target region at a discharge current of 1 A ( $n_e = 0.9 \times 10^{15} \text{ m}^{-3}$ ).

### Ion-Ion Plasma Experiments in a Helicon Source

A helicon plasma system has been designed and developed at CPP-IPR which will be used for production and experiment of ion-ion plasma using electronegative gases. The entire chamber system (stainless steel + glass) was pumped down by using Turbomolecular pump(1000 l/s) backed by rotary pump and a base pressure up to  $8.5 \times 10^{-6}$  mbar was obtained. The six solenoid magnets are made and installed along the axis of the chamber after testing. Radio Frequency Generator of 13.56 MHz and 3 kW RF power with matching network was installed in the Helicon plasma system. Figure A.1.8

shown the argon plasma produced with a working pressure of  $10^{-3}$  mbar, RF power at 100 W and the B field at 300 Gauss.

### CPP-IPR Magnetized Plasma Experiment for Plasma Surface Interaction (CIMPLE-PSI)

This is a linear magnetized tokamak divertor simulator system developed for ITER relevant Plasma Surface Interaction (PSI) studies. The system uses a segmented arc source for production of a plasma jet, which is confined into a collimated beam by an axial magnetic field (0.45 Tesla) produced with a water cooled electromagnet. Four roots vacuum pumps of total 14,000 m<sup>3</sup>/h capacity ensures few pascal pressure near the plasma material interaction region through differential pumping geometry. At a 200 kW power operation with a plasma density of  $1.4 \times 10^{20}$  m<sup>-3</sup> and temperature in the range of 1-2.7 eV, the ion and heat flux parameters were estimated to be  $0.4 \times 10^{24}$  m<sup>-2</sup>s<sup>-1</sup> and 6.9 MW/m<sup>2</sup> respectively. The diagnostics capability were enhanced with the introduction of a retractable Langmuir probe system and water calorimeters of different sizes. This device will be also augmented by integration of ELM like laser pulses, which will result in an

unique system, that will help in understanding the synergy of the steady-state plasma and transient heat pulses.

### A.1.2 Aditya Tokamak

**Status of the Machine:** The Aditya tokamak ( $R_0 = 75$  cm,  $a = 25$  cm) having a limiter configuration has been upgraded to a tokamak with divertor configuration. It has been designed to produce a circular plasma with plasma current  $\sim 150 - 250$  kA, plasma duration of  $\sim 250 - 300$  ms with electron density and temperature in the range of  $3 - 5 \times 10^{19}$  m<sup>-3</sup> and 500 eV – 1000 eV respectively. Further, it has also designed to obtain shaped plasmas with plasma current  $\sim 100 - 150$  kA, elongation ( $k$ )  $\sim 1.1 - 1.2$  and triangularity  $\sim 0.45$ . After successful commissioning and integrated power testing of machine, the installation of various sub-systems has been completed to obtain the first plasma discharge. Figure A.1.9 shows the Aditya U tokamak with pumps, diagnostic and other peripheral subsystems, ready for operation. Two turbo molecular pumps and two Cryo pumps are installed on vacuum vessel. The total gas load of the vessel and in-vessel components generated by global leak rate, total out gassing rate and per-

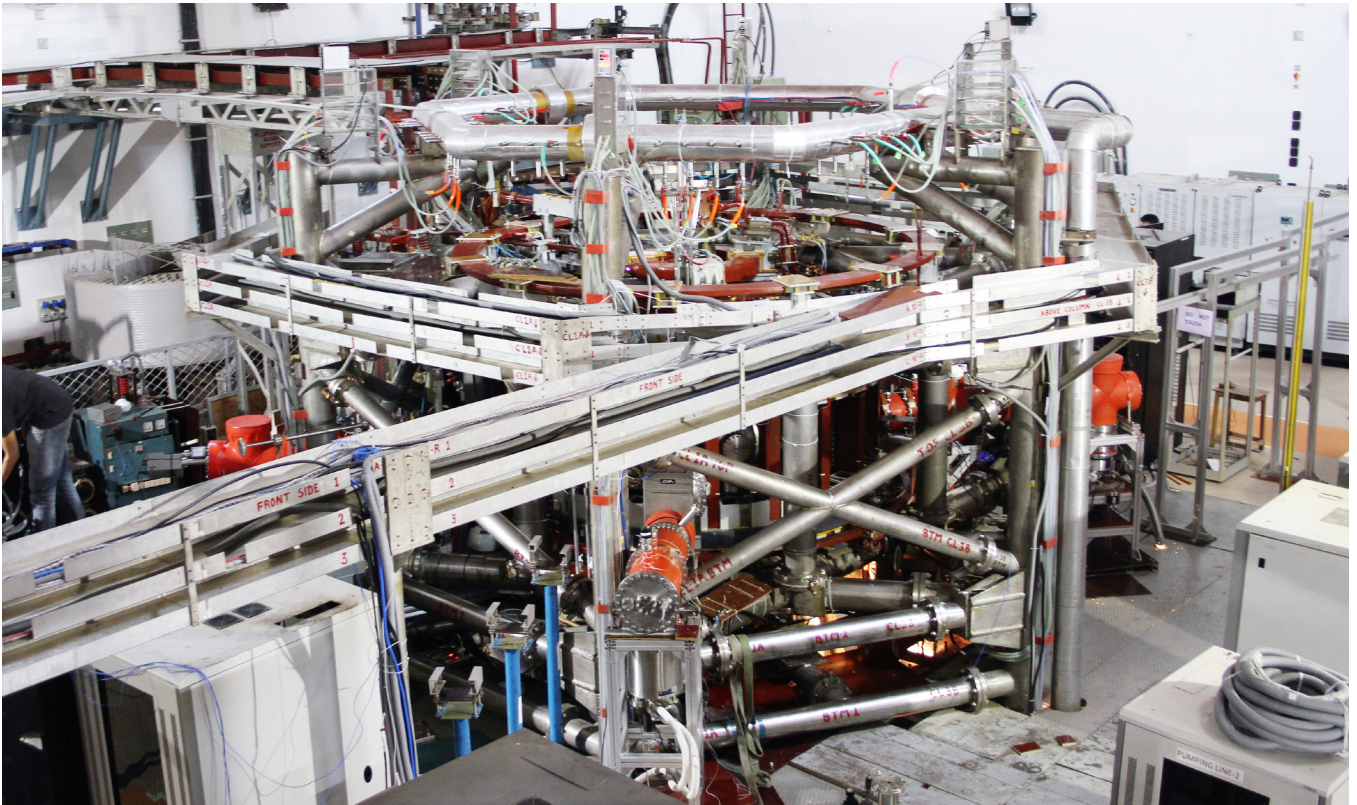
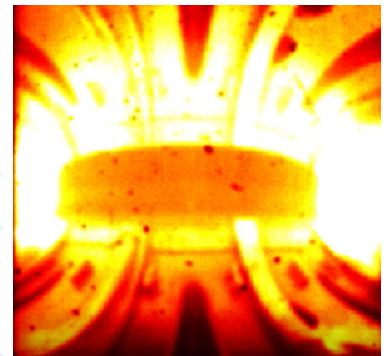
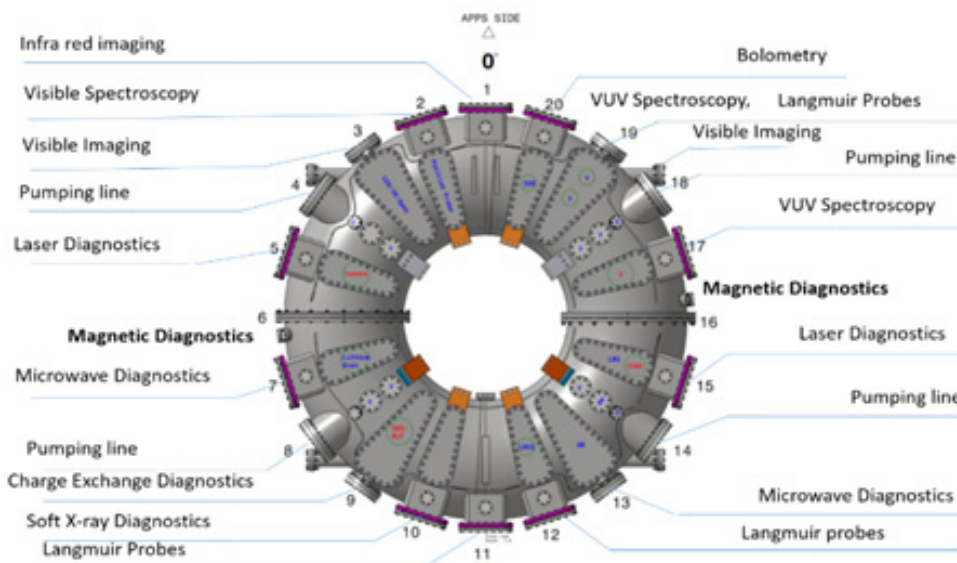

Figure A.1.9 Top view of Aditya – U tokamak with installation of pumping lines and various sub-systems



**Figure A.1.10**  
 Left : Top View of port allocation of different diagnostics along with pumping lines.  
 Right : Image of typical Aditya-U discharge (# 30360)

meation has been maintained  $\sim 10^{-6}$  mbar.litre/s to achieve ultimate vacuum as  $\sim 10^{-9}$  mbar. The magnetic diagnostics such as flux loops, two poloidal arrays of magnetic probes (Mirnov coils), for plasma position measurement, diamagnetic loop, four internal Rogowski coils have been installed in Aditya-U. Apart from magnetic diagnostics, spectroscopic, microwave and other diagnostics such as soft and Hard X-ray detectors, bolometers, electric probes are installed for the first phase of plasma operation. The location of different diagnostic on vacuum vessel is shown in the Figure A.1.10 (left). For recording the data gathered by different diagnostic systems, PXI based data acquisition systems are used. To facilitate the smooth communication among systems lying in tokamak hall and the power supplies, an optical fibre based trigger transmitters and receivers system with programmable delay setting has been design, develop and installed. After data transferred to Server, it is available on IPR-intranet and can be retrieved and analysed using MATLAB / MDSplus/ Other analysis software.

**Plasma facing Components:** The plasma boundary is formed using inboard toroidal ring Limiter made up of Graphite in the first phase of operation. Apart from the toroidal ring limiter there exist one outer limiter assembly installed at one particular toroidal location with poloidal extent of 1/4 of poloidal periphery of vessel in first phase of operation. In addition, one pair of the safety limiter which is a poloidal ring of graphite tiles placed inside vessel at toroidally symmetrical locations. The divertor plates will be installed in second phase of operations.

**Error Field Measurements and Simulation Studies:** Error magnetic field, the unwanted Br and Bz components of magnetic fields due to transformer (Ohmic) coils inside the vacuum vessel), have been measured at 2 different toroidal locations as a function of Radius R and height Z. It is observed that the error fields are reduced in magnitude as compared to previously estimated values.

**First Plasma After Upgradation:** The first discharge in Aditya-U has been obtained on 1st December 2016. Prior to the operation, the performance of Aditya-U vacuum pumping system had been tested successfully to achieve base vacuum in the range of  $10^{-8}$  Torr. Then suitable discharge cleaning has been carried out using glow discharge cleaning mechanisms for several hours on several days. The pumping system is again tested successfully for high gas feed pressure in wall conditioning operations in the pressure range of  $10^{-4}$  to  $10^{-2}$  Torr for long hours ( $\sim 12$  hours). Initially repeatable plasma discharges of plasma current of  $\sim 80-95$  kA with duration of 80–100 ms with toroidal magnetic field BT (maximum)  $\sim 1$ T and chord-averaged electron density  $\sim 2.5 \times 10^{19} \text{ m}^{-3}$  and temperature (estimated)  $> 150$  eV has been obtained The disruptions during the plasma current-flattop due to sudden growth of MHD modes are steered through by properly adjusting the ramp rate of plasma current. The generation of runaway electrons are controlled using high fill in pressure during the breakdown phase and by suitable external hydrogen gas puffing during the plasma current flat-top. Later, the discharge duration has been enhanced up to 180 ms with the application of negative converter power supply. All the subsystem of the Aditya-U machine have been performed as desired and the

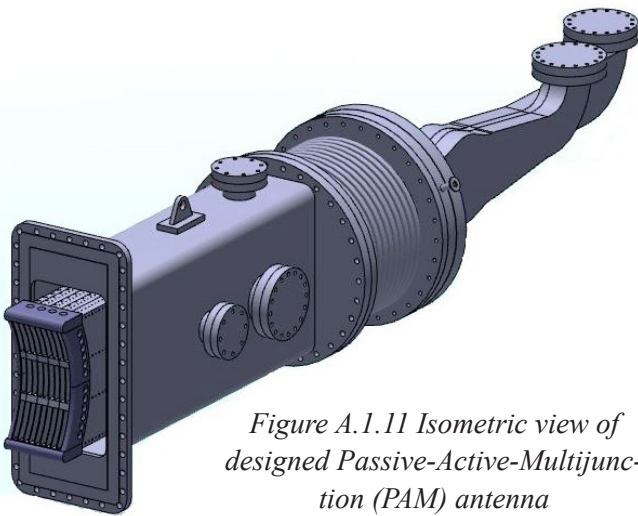

Figure A.1.11 Isometric view of designed Passive-Active-Multijunction (PAM) antenna

initial discharges are very satisfactory in terms of the functionality of the machine.

### Heating and Current Drive Systems

**Electron Cyclotron Resonance Heating (ECRH) System:** the 42GHz ECRH system would be used to carry out experiments at 0.75T and 1.5T operation. This system has been used previously with Aditya. Now the layout has been modified to connect the system with Aditya-U. The necessary support structure has been procured to connect the transmission line. The system will be installed soon as per the clearance from Aditya-U.

**Lower Hybrid Current Drive (LHCD) System:** A new LHCD antenna, based on passive active multi-junction (PAM) is under development for Aditya-U machine and for which the design has been completed. Figure A.1.11 shows an isometric view of the designed PAM antenna, which would launch lower hybrid waves in to Aditya-U plasma. Fabrication drawings are completed. The purchase procedure for fabrication is initiated. Proposal is on reflectometry to measure the edge density profile in Aditya-U tokamak to understand the coupling of LH waves launched from PAM antenna. The specification is finalized for the reflectometry system for the Ka band frequency of 26 GHz – 36 GHz. Design for the horn antenna is carried out for transmission and receiving of signals. Optimization of horn antenna would be required for the available space and better directivity. Voltage Controlled Oscillator (VCO) prototype board is designed for generating the frequency according to tuning voltage which is generated through FPGA programming. The VCO section has been designed, fabricated and tested. I-Q demodulator card is designed, fabricated and is being tested.

**Ion Cyclotron Resonance Heating (ICRH) System:** For Aditya tokamak ICRH had a capability of introducing 200 kW RF power only and still many RF experiments like second harmonic heating, wall conditioning, preionization, current ramp up, discharge mitigation etc, were conducted successfully. During the next phase of Aditya up-gradation, it is planned to upgrade ICRH system for introducing RF power up to 5000 kW for doing experiments of second harmonic heating. The power will be introduced through two different ports with the help of two fast wave antennas. Single 9” transmission line will carry RF power from RF lab to Aditya hall and will be divided into two transmission lines with T junction and will deliver RF power to two antennas. Another transmission line will be used for ion Bernstein wave antenna for heating experiments and 100 kW, 45.6 MHz indigenously developed RF generator will be used. Complete layout has been finalized and all required components/equipment like RF switches, vacuum interface section, transmission line, support structure is in the final stages of procurement.

### A.1.3 Superconducting Steady-state Tokamak (SST-1)

To improve the quality of discharges in the SST-1, various tasks are being carried out as suggested.

*(a) Characterization study of Poloidal Field coils cooling and hydraulics:* SST-1 consists of two types of superconducting coils, namely toroidal field (TF) and poloidal field (PF) coils required for plasma confinement and shaping.



Figure A.1.12 Inside View of current Feeder System



*Figure A.1.13 Water cooling Jacket on Electrical Motors of Helium Screw compressors*

The NbTi superconductor based cable in conduit conductor (CICC) of critical temperature 9.4 K at zero magnetic field, have been used for both coils. These magnets are force flow cooled with helium. In the previous experimental campaigns, TF coils were cooled up to 5 K and charged up to 4.5 kA for more than seven hours for SST-1 plasma experiments. PF coils were also cooled up to 15 K, which is above the critical temperature of NbTi superconductor, hence, these coils were not charged with electrical current.

In order to cool PF coils below the critical current, hydraulic circuit has been changed from the current feeder chamber side and cooling characterization was done. As a part of this study, the following tasks were carried out : (a) Installation and commissioning of new additional cryo Valves for group wise regulation of flow within the existing Integrated Flow Distribution and Control (IFDC) system; (b) Isolation of return paths of PF Hydraulics at the current leads assembly chamber (CLAC); (c) Installation, commissioning of new modifications within the CLAC ; (d) Introduction of new 2R-Cryo line from CLAC to IFDC. The above-mentioned tasks undergone routine helium leak testing at Room Temperature under sniffer mode and the level of helium leaks are found to be acceptable.

(b) *Trouble-shooting of Automatic Closing/Opening hydraulic Assembly in the Current feeders system:* Maintenance of Gear-Box Assembly of the Current feeders system has been carried out and made the Gear-Box Assembly operational.

(c) *Performance Enhancement of Electrical Motors of Helium Screw Compressors:* In order to minimize wear and tear of Ball-Bearing of 315 kW rated Electrical motors due to very high ambient temperatures within the IPR helium compressors station for round the clock operation, an innovative and indigenous technical solution has been realized to keep the electrical motor currents in the acceptable range as well as enhance the life of Ball-bearings. This solution envisaged the introduction of water cooling jacket locally at the D-side of bearings as depicted in the figure A.1.13.

(d) *Upgradation of Magnet Data Acquisition System:* Magnet data acquisition system has been upgraded with (i) 64-bit Window and linux support, (ii) Live TF and PF Mass flow calculation; (iii) 100000 samples per CSV file; (iv) Implementation of new off line data plotting utility with origin 8.5; (v) PLC based DAQ software with existing VME software; (vi) Live screen indication of Minimum, Maximum and Average temperature.

## Heating and Current Drive Systems

*Electron Cyclotron Resonance Heating (ECRH) System:* The 42GHz ECRH system has been used successfully for pre-ionization and start-up of SST-1 tokamak plasma. Approximately 150kW to 250kW ECRH power is launched in SST-1 for 100ms to 300ms duration and several experiments have been carried out at 1.5T operation in SST-1. The 82.6GHz-200kW ECRH system has been integrated on SST-1 for pre-ionization and start-up of SST-1 tokamak plasma at

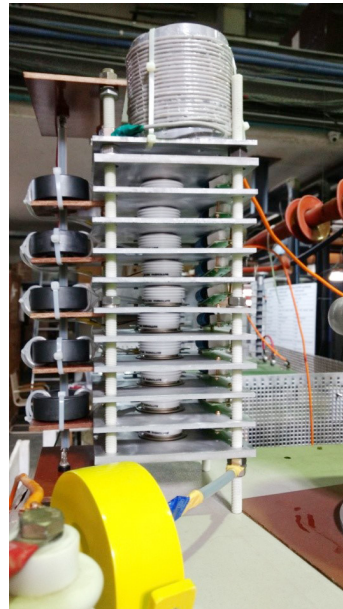

*Figure A.1.14 Indigenously developed Solid State Crowbar*

3.0T operation.

***Technology development related to ECRH:*** In order to operate the Gyrotron with reliability and for multi-pulse operation, the existing system has been modified and other technologies related to high voltage has been developed.

***A Development of tail-bite system for Anode power supply:*** The existing anode power supply has limitation to operate for more than one pulse due to its slow fall time. A dynamic low impedance based tail-bite system has been developed and integrated successfully with the existing anode power supply. The integrated system has been tested successfully up to 20kV for multi-pulse operation.

***B. Solid state crowbar development for Gyrotron:*** A remarkable development has been done by ECRH division to operate the Gyrotron safely. The technology for solid state crowbar has been developed successfully. It is an important indigenous technology development in the field of high voltage. The system has been tested successfully up to 20kV, this crowbar removes the high voltage within 10 micro-s. The 30kV solid state crowbar is under testing and 50kV is scheduled in next 2 years.

***C. VME DAC system Upgradation:*** The VME based DAC system for ECRH has been upgraded for two pulse operation (Start-up as well as heating in plasma).

***D. Real time feedback launcher:*** The advance launcher capable to steer the beam with proper feedback is under design stage. The conceptual design has been carried out and engineering design in progress.

E. The prototype calorimetric power measurement in pulse condition is developed using microcontroller.

***Lower Hybrid Current Drive (LHCD) System:*** The LHCD system is made available for experiments on SST1 during campaign-X VI I to XIX. Prior to campaigns, the LHCD grill antenna and vacuum window are actively cooled throughout the baking cycle, during which SST1 machine and its PFC's inside the machine is baked up to 250 °C. Later, the standard procedure for high voltage and RF conditioning is followed to bring up LHCD high power sources for the said campaigns. The klystrons are operated, in parallel mode, with regulated high voltage power supply (RHVPS). The LHCD power has been successfully launched in to the SST1 machine during these campaigns and encouraging results have been obtained.

Temporal elongation of plasma pulse is observed. Scintillating detector (CdTe) signal confirm generation of suprathermal electrons responsible for non-inductive current drive due to LHCD. Spikes are also seen in loop voltage with LH power, which are the characteristics of LH power in low density discharges. Gas puffing from near the grill antenna is also carried out for local ionization of gas with LH power to increase the edge density for improving the coupling of LH power with plasma. A marginal increase in edge density is observed with gas puffing from antenna side in presence of LH power and thus significant improvement in reflection coefficient is not observed.

--!!--

## A.2 Technology Developments

Under the purview of continuous progress in Plasma Science and Technology, many technologies are being developed. A brief about the technologies developed under various heads are given here.

A.2.1 Magnet Technology.....	13
A.2.2 Divertor & First Wall Technologies.....	14
A.2.3 Cryo-Pump & Pellet Injector System .....	15
A.2.4 Test Blanket Module (TBM) .....	15
A.2.5 Large Cryogenic Plants & Cryo-systems (LCPC).....	18
A.2.6 Remote Handling & Robotics Technology.....	19
A.2.7 Negative Ion Neutral Beam System.....	20

### A.2.1 Magnet Technology

This programme caters to the development of different magnets which will be used for confining plasma in various configurations.

**Nb3Sn based superconducting CICC:** The manufacturing of ~ 1000 m of 14 kA Nb3Sn based CICC is under progress with Indian Industry. The manufacturing parameters for this CICC such as percentage of cold working, sizing and shaping dies, linear feed and hammering frequency has been optimized and demonstrated on 10 m dummy CICC. The heat treatment of Nb3Sn superconducting strands and cables from various twisting stages is carried out with respect to required heat

treatment schedule. Successful heat treatment of bobbin samples, straight wires and sub-cables has been carried out. Further samples investigations for development of superconducting phases using EDAX and for its critical current capability at 5 K are going on.

**Winding Facilities:** Special purpose winding machine for manufacturing of saddle shape coil has been installed and demonstrated by winding of dummy coil at IPR. Apart from this, lab scale solenoid as well toroidal winding machine has also been installed and currently used for the winding of small lab-scale solenoid magnet.

**Material characterization facility at low temperature (MC-**



Figure A.2.1 Integrated MCFLT at factory site



Figure A.2.2. Special Purpose Winding Machine for saddle shape coil

**FLT):** The integration of MCFLT system has been completed successfully at factory sight as shown in figure A.2.1. The initial testing trials at room temperature and 77 K have been completed at factory site. The test plan for pre-dispatch inspection for MCFLT is under progress. MCFLT facility is expected to install in IPR by end of this year after its performance validation at factory site.

### A.2.2 Divertor Technologies

This programme continued its efforts in developing materials & fabrication technologies for Plasma Facing Component (PFCs), nondestructive evaluation/testing and high heat flux testing of PFCs and establishing/improving new test facilities at IPR. A brief of the major works done are given here.

#### **Tungsten Coating Technology Development for First wall**

**Application:** Additional test mock-ups made of Copper Alloy, Stainless Steel and IN-RAFMS steel substrate materials coated with 500micron thick Pure Tungsten material over 50mm x 30mm surface area are fabricated by collaborator - ARCI (Hyderabad). Integrity and uniformity of tungsten coating is checked using Ultrasonic Testing Technique. These tungsten coated test mock-ups are successfully tested for their thermal cyclic fatigue performance at 500°C surface temperature for 1000 thermal cycles. High Heat Flux Test Facility (HHFTF) has been used for these tests.

**High Pressure High Temperature Water Circulation System (HPHT-WCS) for HHFTF:** Installation & Commissioning of HPHT-WCS has been successfully completed. This can supply water up to 60bar pressure, 160C temperature and 300lpm flow rate. HPHT-WCS is also integrated with



Figure A.2.3. High Pressure High Temperature Water Circulation System (HPHT-WCS) for HHFTF

HHFTF for supplying coolant water to component for testing its performance under high heat flux conditions.

**Dome Fabrication and testing:** ITER-like dome (scaled down version) is fabricated using tungsten macro-brush brazed to copper-alloy substrate having hyper-vapotron cooling channel. Ultrasonic testing is performed to know flaws in brazed joint between tungsten and copper interfaces. High heat flux testing of dome is performed using HHFTF at IPR. Dome could successfully withstand 1000 thermal cycles at incident heat flux of 3.3MW/m<sup>2</sup> using 15.6kW e-beam power and 200 thermal cycles at 5.3MW/m<sup>2</sup> using 24.6kW e-beam power.

**Tungsten Materials Development:** GLEEBLE 3800 system is used for development of tungsten-copper functionally graded material by Direct Sintering of pure tungsten and pure copper powders stacked in layers to achieve desired density gradient of tungsten and copper materials.

**Materials Studies:** Material joining studies relevant to fabrication of plasma facing components are continued. Diffusion bonding and brazing of metallic materials are performed

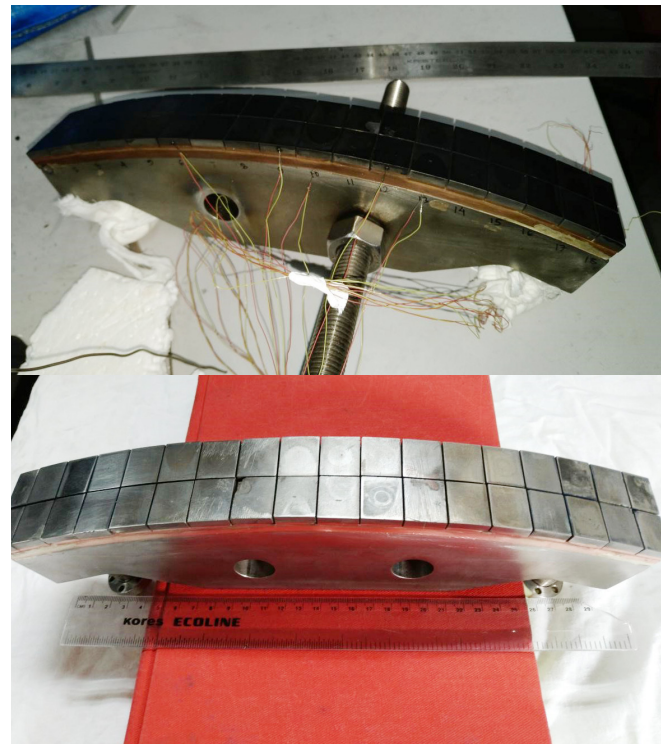

Figure A.2.4 Fabricated DOME successfully tested up to 5MW/m<sup>2</sup> using HHFTF

at elevated temperatures and pressures using Gleeble 3800 System. Studies on welding of 10mm to 40mm thick sections of SS316LN and XM19 (dissimilar structural materials relevant to divertor cassette body fabrication technology development) are carried out as a BRFSST project undertaken by PDP, Gandhinagar. Development and characterization of Tungsten-Copper functionally graded materials for plasma facing component is initiated as a BRFSST project undertaken by IMMT, Bhubaneswar.

**Brazing Studies and Brazing Experiments:** Brazing, casting, annealing experiments are performed to develop technologies relevant to fabrication of plasma facing components. Vacuum Brazing of BZT Ceramic with Titanium using TiCuNi (at 980°C) and CuSIL-ABA (at 850°C) is performed for RF Window development related work.

**Ultrasonic Testing & Simulation:** Mechanism to inspect tungsten monoblock divertor with curved copper-alloy tube is finalized. Purchase order is released for supply of ultrasonic probe mounted on flexible shaft. Studies on estimation of mechanical properties of materials (relevant to fabrication of plasma facing components) based on ultrasonic wave velocity measurements are initiated. Phased Array ultrasonic probe is used to study sensitivity criteria for inspection of defects in thick-section weld joints.

### A.2.3 Cryo-Pump & Pellet Injector System

**Concept and Design evolution of twin screw cryogenic screw extruder for pellet injection:** Technologies related to fuelling of plasma in form of frozen hydrogen cylindrical shaped solid pellets is under progress. The indigenously developed SPINS-IND, a single barrel pneumatic gun type pellet injector is successfully operating and is able to freeze cylindrical pellets of size ranging from 1.8 mm to 4 mm. Pellet velocities achieved is a function of pellet size and propellant pressure. SPINS-IND has the achieved velocity range of 700-1000 m/s for 4-2 mm size pellets respectively. Taking a step further development of twin screw cryogenic extruder system is undertaken. Extruder type pellet injector (ETPIS) pushes solid hydrogen forward with counter-rotating inter-meshing screws driven by servomotor capable of extruding sufficient solid hydrogen to extrude 3 mm (L) x 3 mm (D) size pellets at 10 Hz injection frequency. The concept of extruder incorporates four stage of cool down, independent support mechanism of twin screw assemblies and high frequency inline injection scheme. For validating the proof of an argon extruder operating at liquid nitrogen temperature was realized. Argon

is liquefied within a heat exchanger dipped into a LN<sub>2</sub> filled closed container with a specified mass flow rate. Liquefied argon is then feed into the extruder chamber where it gets solidified and extruded through the nozzle. Based on the studies carried out for argon extruder technical bottlenecks were with real-time implementation in experiments. Screw gear and motion concept, cryogenic sealing criticalities and the thermal mass and conductivity related problems were identified. During experimental exercise argon liquefaction and assembly cool-down to 86K was observed with a twin screw motion at around 5RPM.

### A.2.4 Test Blanket Module (TBM)

Indian Lead Lithium Ceramic Breeder (LLCB) blanket concept will be tested in ITER through Test Blanket Module (TBM) program. The objective of the ITER TBM Program is to generate experimental data on the performance of tritium breeding blankets in integrated fusion nuclear environment. This programme is engaged in the Design and Development of LLCB TBM and its associated ancillary systems.

#### ***Test Blanket System (TBS) and Blanket Neutronics Activities***

**Development of IPR Interface Code for Shutdown dose rate estimation in Fusion system (IICSF):** An interface code (IICSF) which couples the radiation transport tool and activation tool has been developed to simulate the shutdown dose rate. The code IICSF has been validated with a computational benchmark exercise which has been developed by ITER organization for shutdown dose rate calculation. This code (IICSF) is capable of simulating the dose rate in the fusion nuclear system at any area of the machine and at any time after shutdown in a single run.

**Nuclear Analyses of Neutron Activation System for Indian TBM in ITER:** Neutron Activation system has to be mounted in Indian Test Blanket Module for measurement of nuclear responses by sending the foils and capsules during neutron irradiation in ITER. The analyses have been performed to analyse the compatibility of systems with TBM and to assess the irradiation durations of foils & capsules which are required to plan the handling of irradiated foils & capsules. The outcome of the analyses has supported the NAS design.

**Joint Benchmarking Exercise with China TBM team to establish the common shutdown dose rate (SDDR) estimation methodology:** China TBM team to establish the common

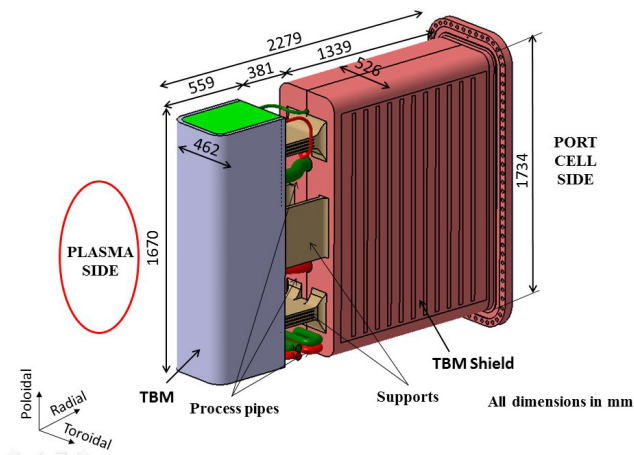

Figure A.2.5 Lead Lithium Ceramic Breeder (LLCB) Test Blanket Module (TBM) Set

shutdown dose rate (SDDR) estimation methodology: India is sharing the ITER port#2 with China for testing its breeding blanket module. Since the areas of maintenance are common for both, an exercise has been launched to establish a common methodology to estimate the SDDR in ITER. The Outcome of the exercise is showing the good agreement in SDDR results between both teams and also with Korean TBM team results.

**Preliminary Estimation of Occupational Radiation Exposure during the Indian TBS maintenance activities in ITER:** Indian Test Blanket Systems (TBS) will be placed in ITER for the performance testing. During the ITER operations and shutdown phase, maintenance activities are required in TBS for smooth functioning and to avoid the accidents. Since ITER is a nuclear machine, therefore radiation exposure for workers should be limited as per IAEA requirements. The preliminary estimation of occupational radiation exposures for Indian TBS maintenance activities has been carried out.

**Neutronic mock-up experiments for TBM Shield module neutronic Design validation:** A Shield module is associated with Indian test blanket module to provide the shield to human accessible zones from neutron radiations. A Preliminary neutronic design and analyses have been performed for shield module. To validate the neutronic design of shield module mock experiment will be performed in IPR 14 MeV neutron source lab. Design of the experiment has been completed and mock-up of TBM Shield has been fabricated. Neutron irradiation of mock-up will be conducted soon.

**Engineering Design Activities:** The conceptual design re-

view activities for the Indian LLCB-TBS and associated IO-Activities have been completed. ITER Organization has given the approval to proceed to the next development (Preliminary Design) phase. Currently, the design of various components of TBM is being updated and further optimization in the design of LLCB TBM set including feasibility of the challenges in engineering design and fabrication methodologies will be addressed in PD phase. The First Wall (FW) of TBM has been modified and optimized considering the lower Helium mass flow requirement. The internals of TBM has been altered to make the design ease to fabricate as well as to improve the process parameters like higher temperature window of ceramic breeder zones for tritium release. The design of Neutron Activation System has also been considered in LLCB TBM design. The alternate design of back plate for FW helium manifolds to incorporate NAS is in progress. In the design of supports between TBM and shield, the cylindrical configurations as well as plate configuration with bolting mechanism is under study to avoid the dissimilar welding. All the design and analysis activities will to be qualified as per RCC-MR code used for the design, fabrication & testing of TBM set.

Indian TBM is using IN-RAFMS as first wall structural material, which will experience higher operating temperatures that would cause high thermal stress to the material. In this connection, an R & D experiment was setup to measure strain in ferritic steel (P91) plate of different thickness (6mm and 11mm) which is surrogate material for RAFMS. The experiment will be performed in next design phase.

**Liquid Metal Process and MHD Activities:** Lead Lithium Cooling System (LLCS), is the primary coolant system of LLCB TBS, which will extract the heat generated in the nuclear fusion reaction occurring inside ITER. Various R & D activities towards Pb-Li technology are in progress at IPR, to establish the efficient and safe operation of LLCS in ITER's harsh operational conditions of high temperature, magnetic field and radiation environment. A continuous operable highly sensitive rectangular Halbach flow meter was designed for lead lithium applications. Recently, a Pb-Li alloy production system, based on electromagnetic stirring technique, has been successfully commissioned at IPR and few batches of Pb-Li alloy of desired composition (Pb-16Li) have been produced. An indigenously developed cold trap unit was tested in a high temperature Pb-Li loop for in-situ Pb-Li purification. The experimental results show collection of PbO and Li<sub>2</sub>O in the SS sieve of the cold trap unit. A Pb-Li experimental loop (refer Figure A.2.6) has been fabricated and is being operated



Figure A.2.6 Panoramic view of the Lead-Lithium (Pb-Li) heat transfer experimental loop

for heat transfer studies. The Pb-Li MHD experimental loop has attained the final design stage and procurement of major components is completed. The loop assembly will start very soon. Progress is also made in 3D thermo-fluid MHD analysis using numerical MHD codes. Several benchmark problems have been solved.

**Structural Material Development Activities:** These activities are under progress to develop India-specific Reduced Activation Ferritic Martensitic Steel (IN-RAFMS) and qualification for its use in LLCB TBM. IN-RAFMS is being developed in collaboration with IGCAR and M/S MIDHANI. The extensive data base is being generated in IPR and IGCAR. To qualify the material as required by ITER, large heats of IN-RAFMS has been produced to generate the physical and mechanical properties database as per the RCC-MRx guidelines. Tensile properties have been generated in as-received condition as well as simulated post weld heat treatment condition. Fatigue properties for IN-RAFMS have been completed and submitted to IO. Electron beam, TIG and HIP joints have been proposed for weld properties data generation and determination of weld strength reduction factor. Extensive testing and database generation from large heat is under progress.

**Corrosion studies of Indian Reduced Activation Ferritic-Martensitic Steel (RAFMS) with Lead Lithium Eutectic:** To carry out the corrosion studies, a pump driven loop has been set up in TBM lab at IPR. The test section is maintained at 465°C and the liquid metal is flowing at 10 cm/sec velocity. Flat and tensile IN-RAFMS sample coupons are loaded in test section. The loop completed 2500 hours operation. Samples are taken out and characterized with SEM on surface and cross section. Hardness testing and tensile testing

are also carried out. One more system is developed in which samples can be rotated at required velocity (from (10-100) cm/sec)) in Lead Lithium maintained at required temperature (350-500) °C.

**Fabrication Technologies Development Activities:** A 10 channels mock-up of TBM FW (U-shaped) has been fabricated indigenously at vendor site in Mumbai with technology support from BARC. The dimensions of this mock-up for bends & channels meet the requirements of LLCB TBM Design. Mock-up has been hydro tested & helium leak tested. As a next phase activity half size TBM first wall would be fabricated. Development of U-shaped FW 8 channel mock-up using IN-RAFMS steel by HIP joining (High pressure and elevated temperature diffusion welding) process is being carried out. This is an alternate fabrication route being established as a part of enabling technologies R & D. The isometric representation of mock-up to be HIP bonded. The TBM back plate assembly mock-up using electron beam welding process has been taken up in order to demonstrate the manufacturing feasibility of the TBM Back plate design. Engineering drawings of components and assembly, technical specifications for fabrication, inspection and performance testing of mock-up assembly have been prepared and work is under progress.

**Ceramic Pebble Development Activities:** Lithium Titanate Ceramic Pebble production capacity has been upgraded to 5 kg of qualified pebble per month. At every stage of pebble fabrication (powder, pellet and pebble preparation) extensive characterizations are also being carried out to meet the desired properties. These fabricated pebbles have also been characterized in different international R & D laboratories (China, European Union, Korea & Japan) under the round

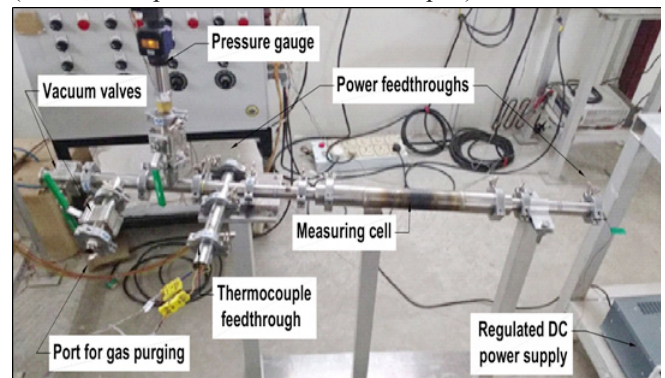

Figure A.2.7 Experimental set for thermal conductivity measurement using hot wire method

robin test as a part of IEA solid breeder subtask. An experimental set up for measuring the effective thermal conductivities by steady state and hot wire method (Figure A.2.7) have been indigenously built at IPR. Presently experiments with the pebbles are under progress. Effective thermal conductivity of  $\text{Li}_2\text{TiO}_3$  pebble bed has also been estimated numerically using COMSOL for different packing arrangement

**Helium Cooling Systems Development Activities:** An Experimental Helium Cooling Loop (EHCL) facility (450 °C, 0.4 kg/s) is being set up to perform R & D experiments and to experience the operation and control requirements for FWHCS and LLHCS. The conceptual design of the EHCL was carried out in-house and the procurement of loop equipment such as circulators, heat exchangers, electrical heater, valves, and instrumentations are under progress. The helium circulators along with their test loop were installed and the performance tests of the circulators were conducted successfully. The circulator test loop is operational .

**Instrumentation & Control Design and Development Activities:** A compact and rigid sensor was conceptualized & customised using a K-type multilevel thermocouple and thermo-well assembly. This sensor was experimentally validated to measure bulk temperature profiles as well as to estimate liquid Pb-16Li level. Long duration test (over 1200 hours) was performed to estimate the reliability and longevity of the sensor assembly in liquid Pb-16Li environment. Automation was implemented in corrosion experiments for Indian RAFM steel in pump driven liquid Pb-16Li loop. A multi-channel data acquisition & monitoring application was developed using LabVIEW platform. • Preparation of Process Flow Diagram (PFD) and Process and Instrumentation Diagrams (P&IDs) for Neutron Activation System, First-Wall Helium Cooling System, Lead-Lithium Helium Cooling System, Lead-Lithium Cooling System, Coolant Purification System, Tritium Extraction System has been completed.

**TBM Safety and Neutron Diagnostics Development Activities:** During the report period several input data in specific to LLCB TBM systems, operational states, radiological data, tritium release and management data, Instrumentation and Control (I&C), Human factor integration plan (HFIP), maintenance operations and data for ESP and ESPN classification has been generated and submitted to ITER Organization. Neutron Activation System is a diagnostic for neutron energy and spectra measurement. Conceptual design of Neutron Activation System (NAS) is carried out including major parameters like capsule dimensions of activation foils, capsule size,

transfer station, capsule transfer pipes, driving gas pressure etc. A test facility is developed to demonstrate functionality of this system.

## A.2.5 Large Cryogenic Plants & Cryo-systems

This programme is mainly involved for the indigenous helium refrigerator/liquefier (HRL) plant development of cooling capacity 1 kW at 4.5 K.

### Manufactured prototype indigenous components:

Manufactured prototype indigenous components: Main indigenous prototype (1/4th of full scale) cryogenic components of plant for phase-A are: 3 different (2-stream-He/He and He/boiling LN2 and 3-stream-He/He/He) kind of cryogenic plate-fin heat exchangers (PFHE) operating between 300 to 15 K with helium flow rate ~30 g/s for hot stream, a helium gas purifiers for test of purification at temperature 80 K and 20 K with flow rate ~30 g/s and a SS filter for helium gas to filtrate dust particles of size more than 20 micron. These have been designed indigenously and manufactured by Indian industries.

**Cryogenic test facility being built-up:** Fabrication and assembly of test facility and tests at low temperature have been started. A test bed was made with heat exchanger for leak tests of PHE2 at 80 K assembled and insulated in open atmosphere. Integral leak rates at 80K are found to be less than 10<sup>-5</sup> mbar-ltr/s and satisfies design requirement. The thermo-hydraulic performance of this heat exchanger will be tested within a vacuum chamber which is under progress. It will include sufficient instrumentations for accurate performance measurements, like, absolute pressure and pressure drops of different streams within heat exchangers, temperatures at different locations, flow rates of different streams.

**Instrumentations and controls development:** Dynamic analysis of the helium turbine test facility operation has been tried using Aspen software. The control logic for the automatic operation sequence of turbines are worked out conceptually. These will be further worked out after which it will be used in the helium turbine test facility. A data acquisition system with display unit for cryogenic sensors has been developed. A monitor which show readings for different cryogenic sensors like temperature, pressure, differential pressure, etc, has been developed indigenously.

### A.2.6 Remote Handling & Robotics Technology

The main focus was in expanding the expertise in the domain of Virtual Reality (VR) development by integrating various VR based applications in a single facility called Virtual and Augmented Reality Integrated Development (VARID) facility. A High payload (~25Kg) articulated arm has also been commissioned at the RHRTD Lab. This system is one-of-its-kind cantilevered system which has been completely designed in-house and fabricated by industrial partners. The system can traverse a toroidal geometry and can carry out inspection and maintenance activities. Further, the division has moved in to some new fields in robotic research and technology such as, Artificial Neural Networks, Visual Servoing, Hyper-redundant robotic systems, Gravity Compensation based robotic systems and advanced safety systems for RH equipment. These new fields of development, coupled to the core research areas of the division, can be used effectively to bring out solution to real-life problems with societal benefits. The major achievements this year are outlined below.

**Virtual & Augmented Reality Integrated Development Laboratory (VARID-Lab):** A low cost solution for Virtual Reality facility has been conceptualized and realized at the remote handling and robotics division. This facility – VARID-Lab will be utilized to develop various virtual and augmented reality applications that will have the flexibility to integrate with remote handling equipment and scale the developed applications to the planned major VR facility. The VARID-Lab facility will serve the following major roles: (a) Platform for rapid design reviews for RH equipment and schemes of existing and future tokamaks at IPR; (b) Facility for application development of specialized VR applications that are not commercially available; (c) Facility to integrate design and analysis tools (like finite element code, multi body dynamics, etc.) into VR; (d) Facility to develop and integrate applications from other domains like haptic feedback, image processing and real time physics into VR; (e) Facility for application development and testing for real-time robotic hardware linked virtual and augmented reality; (f) Centralized control facility with modular architecture for operator training and executing of RH operations.

**Integration of Virtual Reality Applications for Remote handling with VARID-Lab:** The VARID-Lab is being consistently used for various design and control activities for RH systems at IPR. Many VR based applications that were previously developed by the RHRTD Division have been integrated to VARID-Lab. The highlights of some of these

applications are as follows: (a) VR control and monitoring application is created for all available RH equipment at IPR. A specialized control network and application is created to receive the joint data from the equipment and constantly update a VR model at ~8Hz.; (b) A comprehensive master-slave topology with active haptic and visual feedback to carry out remote handling operations in tokamak has been developed; (c) For routine applications like deployment and retrieval of RH equipment from tokamak systems, teach and play algorithms are used.

**Development of Prototype Articulated Robotic System –II (PRAS-II):** PRAS-II system, as shown in Figure A.2.8, has been designed and commissioned. This system is a 5+1 DOF equipment exhibiting snake like articulation for traversing a toroidal workspace. The system is designed to carry a maximum payload of 25kg at 2m. The system will be integrated to haptic controlled virtual reality setup for online control, tracking and monitoring of operations. The following are the major achievements of the development: (i) The system can handle a payload of ~25kg at reach of 2m with positional accuracy of < 2mm ; (ii) The system proves the expertise to design and develop precise remote handling equipment with heavy payload capabilities, a major requirement for future tokamak devices; (iii) The unique real time VR based control and monitoring system makes it easy to use the system in

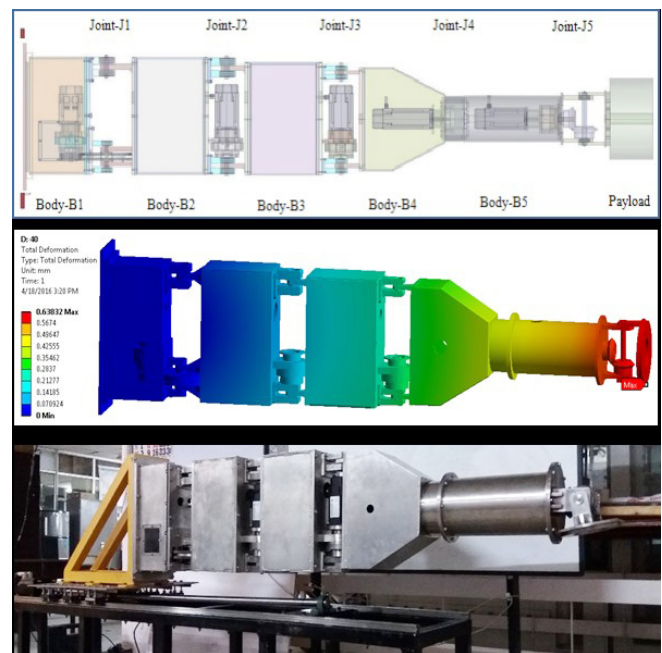

Figure A.2.8. PRASII CAD Model, Structural Analysis, Final System

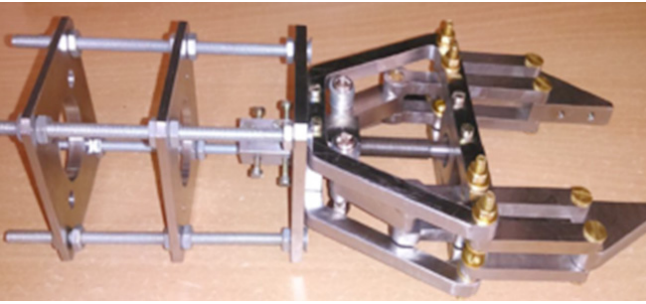

Figure A.2.9 Gripper Assembly developed remote locations.

**Development of Prototype Hyper-Redundant Inspection System (Hy-RIS):** Prototype 3-Axis tendon controlled Hyper-redundant robot for inspection in constrained spaces has been developed at the RHRTD Lab. The complete system design and control system design for the robot has been done in house. Unlike conventional serial manipulator, where each joint has a motor mounted at its axis, the Hy-RIS has a universal joint. The motion of the universal joint is controlled using the plastic tendons which are connected to the motors mounted away from the robot body. Such a system has high dexterity and can be used within constrained spaces within the tokamak environment

**Development of a Prototype Gripper Assembly:** A Gripper Assembly has been designed and developed which can lift up to 1kg of payload. The fabrication was completed using the water-jet cutting machine at IPR. The gripper has been integrated to ABB-industrial robot to demonstrate various applications like tile manipulation and material handling.

**Development of SST-1 Compatible In-Vessel Inspection System (IVIS):** An ultra-high vacuum (UHV) compatible ( $\sim 1e-7$ mbar) and high temperature ( $\sim 150^\circ\text{C}$ ) visual inspection system, IVIS, is under development. The IVIS can be deployed inside the SST-1 like vacuum vessel during plasma campaign without breaking the vacuum. Presently, the design and analysis of the IVIS has been completed. The system is around 4.2m long and has a payload capacity of 1kg. The system is accompanied by a vacuum enclosure chamber called the 'Vacuum Storage Cask' and a mock up chamber to evaluate its performance in various environmental condition. A vacuum compatible camera is being developed separately in-house.

## A.2.7 Negative Ion Neutral Beam System

### A. Twin Source

**Source manufacturing:** Manufacturing of "High Vacuum Compatible components" completed at Hind High Vacuum Company, Bangalore with successful completion of Vacuum Brazing and Mo coating procedures. All the components passed the acceptance test successfully during Pre-dispatch Inspection, which basically includes MSLD leak testing, High pressure water test, visual examination and electrical isolation tests. Components passed the vacuum leak tightness to the requirement of 10-09 mbar-lit/sec. inside cooling lines of plasma facing components were tested with high pressurised water at 8 bar for 30minutes. High Vacuum components have been received at IPR and site acceptance test completed in DNB lab of ITER-India. Further Installation and commissioning activities of TWIN source initiated with integration with TS Vacuum vessel. CAD integration of TWIN source experimental plan completed for AIR mode of operation.

**TS HV Bushing:** FRP based twin source bushing is designed for 50 kV isolation. Insulator is being prepared by filament winding method.

**Installation of RF shield for 180kW RFG:** Installation of RF shield on the 180kW 1MHz in successfully completed at the TWIN Source experimental setup.

**Twin Source DACS:** Twin Source operations are scheduled

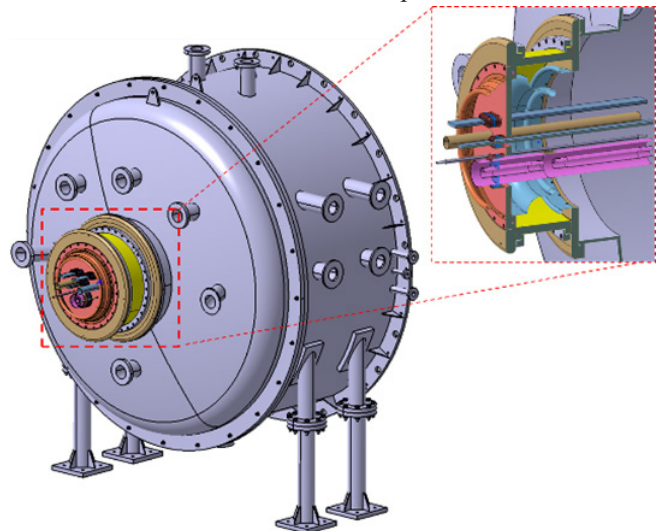

Figure A.2.10 Picture depicting Twin Source High Voltage bushing

in later part of 2017. To support the operations Data Acquisition and Control System (DACS) is presently in advanced stage of completion. The integrated tests of DACS are undergoing with dummy signals and commissioning has been initiated. The software development for data acquisition module has been completed. The GUI is developed on ITER CODAC platform. Various power supplies have been integrated with TS DACS and rest of subsystem of twin source is advance stage of completion. The signal conditioning modules have been fabricated in house for field integration.

## B. ROBIN

**Extraction experiments:** ROBIN is a negative hydrogen ion source experimental facility at IPR. Presently, ROBIN experiments are being performed in the surface mode (with Cesium (Cs) injection) in which negative ions is produced on a low work function surface through surface conversion process of neutrals or positive ions. In the present set-up, negative hydrogen ion beam extraction is effected through an extraction area of  $\sim 73.38 \text{ cm}^2$  (146 apertures of 8mm diameter). The three grid electrostatic accelerator system of ROBIN is fed by high voltage DC power supplies (Extraction power supply System: 11kV, 35A and Acceleration power supply System: 35kV, 15A). The plasma diagnostic i.e. Langmuir probes and Optical Emission Spectroscopy and Beam diagnostic i.e. Beam Emission Spectroscopy and Thermal Differential Calorimeter have been employed in ROBIN to study the source behavior. OES is used to monitor the source impurities as well moreover Residual Gas Analyzer (RGA) is also implemented in ROBIN for the same purpose. Cs is highly reactive and makes Cs compounds which are not desired for the source performance. Impurities were found in the initial phase of experiments in surface mode subsequently modifications have been done to improve upon it. Recently high negative ion current density ( $27 \text{ mA/cm}^2$ ) and low electron to ion ratio  $<1$  have been achieved. The beam divergence measured in the range of  $2.5\text{-}7^\circ$  for different combination of extraction and acceleration voltage. The diagnostic is being developed to find out the Cs distribution over the plasma grid.

**ROBIN DACS:** ROBIN Data acquisition and Control system was upgraded for surface mode operations. Various changes were done in ROBIN DACS components. Calorimeter was integrated with data acquisition system. HVPS was integrated with ROBIN control system. Advanced diagnostics such as Laser Photo Detachment were integrated with ROBIN DACS. New software modules were created for online trend visualization of important parameters. The main control

GUI was modified as per system requirements. Image below shows the main ROBIN GUI. Other important interlocks were also integrated with control system such as PG bias based RF generator interlock and RF power supply interlock for protection of RF generator

### *Electrical System For Robin*

**VSWR Measurement system for RF generator:** The installation, integration and acceptance testing of VSWR measurement system has been performed successfully over 100kW RF dummy load through DACS of ROBIN for a power level of 80kW (1MHz). The system comprises of 200kW directional coupler (Genex make), RF power sensors (R&S make) and optical communication system (S.I. Tech make). The activities related to the final integration of this system with ROBIN is underway.

**Video monitoring system for ROBIN:** For the close monitoring of the HVPS system of ROBIN during its operation and in order to incorporate additional safety in the HVPS facility, bullet camera based close circuit video monitoring system has been installed in the NNB HVPS facility. In addition to this, a PTZ camera based video monitoring system has been installed and integrated to monitor the traces of various signals available on the ROBIN DACS during experiments, in the HVPS facility.

--!!--

### A.3 Societal Benefits of Technology

Time to time, many of the technologies developed in the institute is transferred to various vendors for commercialization. Also many technologies are developed for very special applications as and when it is required. A brief of the technologies being developed and which are under different status are given here.

**Development Of Rigid Plasma Jet:** Rigid plasma jet is developed for BARC-BSG group for studying the effect of plasma on Lung Cancer cells. This jet is made such that the live electrode is in the jet while the body on which the treatment to be given is ground. Helium is used as plasma producing gas. The output power of jet is approximately 2.5-3 watt. The cells are treated with plasma jet for various times such as 2 min, 4 min, 6 min 8 min and 10 min. Preliminary tests shows the cell death of 50 to 60%.

**Development Of Flexible Plasma Jet:** Flexible plasma jet is developed for studying the tumour cell interaction with plasma. The plasma is produced using butterfly catheter. This jet is having electrode less configuration. Helium gas is used as plasma producing gas at the flow rate of about 3 to 5 LPM. The tests are carried out for 5 min, 10 min and 30 min exposure time. The Preliminary experiments show the increase in the ROS concentration as shown in figure – 2, which is required for apoptosis (cell death) of tumour cells.

**Treatment Of Skin Diseases Using Plasma Jet:** An already developed atmospheric pressure plasma jet is being used to treat the skin infection at PG medical college Kolkata under the supervision of skin specialists. This plasma jet can be touched by bare hands and the technology has been successfully transferred to M/s Aditya High Vacuum Pvt. Ltd. This is for the first time after taking the ethical permission; plasma

jet is directly put on human for the treatment of Tinea Cruris (Fungal disease) in India. The patient is treated with plasma jet for 20 minutes. The treatment will go on for one month once a week. After 1st and 2nd treatment, patient is in good state of health and fungal infection is improving.

**Development Of Atmospheric Pressure Co<sub>2</sub> Plasma Source For Nodular Corrosion Studies With BARC & NPCIL:** At NPCIL, nodular corrosion has been identified as one of the reason for pressure tube leak of nuclear reactor. Understanding the root cause phenomena of growth of corrosion is considered critical R&D area to assure long term health of pressure tubes in all PHWRs. In order to check the possibility of corrosion due to ionized carbon dioxide (i.e. radiation ionisation) a lab scale carbon dioxide plasma source was required. At FCIPT, IPR a carbon dioxide plasma source working at atmospheric pressure is developed. This has a potential use in simulation of reactor environment with respect to radiation ionisation for carrying out degradation study of Zr-2.5Nb pressure tube material. The following figure shows multiple plasma jets near the zirconium alloy tube operating in carbon dioxide atmosphere. The resultant nodular growth if observed can help in better understanding of the phenomena.

**Development Of Novel Biomedical Implants With Enhanced Reliability:** The Titanium (Ti)-Titanium Nitride

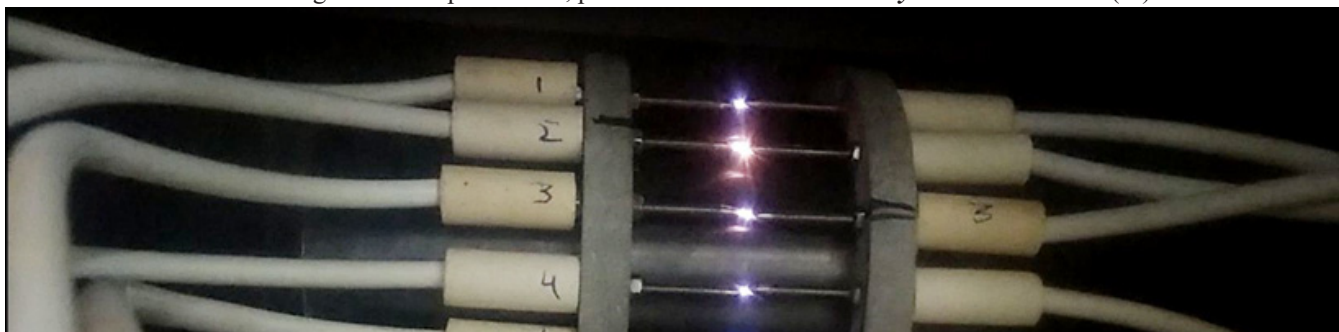

Figure A.3.1 Atmospheric pressure plasma jet is being used to treat the skin infection at PG medical college Kolkata under the supervision of skin specialists.



Figure A.3.2 CO<sub>2</sub> Plasma Generated for Nodular Corrosion Studies

(TiN) multi-layer coating developed on flat stainless steel (SS 316L) and Ti alloy samples as well as on the prototype Hip implants balls for biomedical application. The testing for biocompatibility is going on at CGCRI, Kolkata.

**Development Of Plasma Based Tin Coating System For Amrita University, Coimbatore:** In this project plasma based TiN coating system was developed at FCIPT. The system was successfully installed at Amrita University, Coimbatore. The system is being used to study the deposition of TiN and copper on aluminum substrates used in Aerospace application. The plasma based TiN coating system shown in figure beside was developed and installed at Amrita University, Coimbatore.

**IPR – GIFT CITY CONTRACT**

A MOU has been signed with GIFT city (Smart city Gandhinagar) for installation and commissioning of plasma pyrolysis system of 150kg/day capacity. GIFT city has placed a work order to ipr’s technology licensing partner M/s B.L. Engineering (BLE) for this project activity. BLE has installed and commissioned the system at gift city in march 2017 under the technical consultancy of ipr team. This system has a fully automated remote feeding system for paper, plastic and STP (sewage treatment plant) waste coming out from other waste treatment plant in gift city. The whole plant is run by various instrumentations and PLC and HMI based control system. This system has successfully been commissioned.

**Microbial Inactivation Using Plasma Activated Water:** Plasma-activated water (PAW) is defined as the water exposed to non-thermal or thermal plasma where chemical species

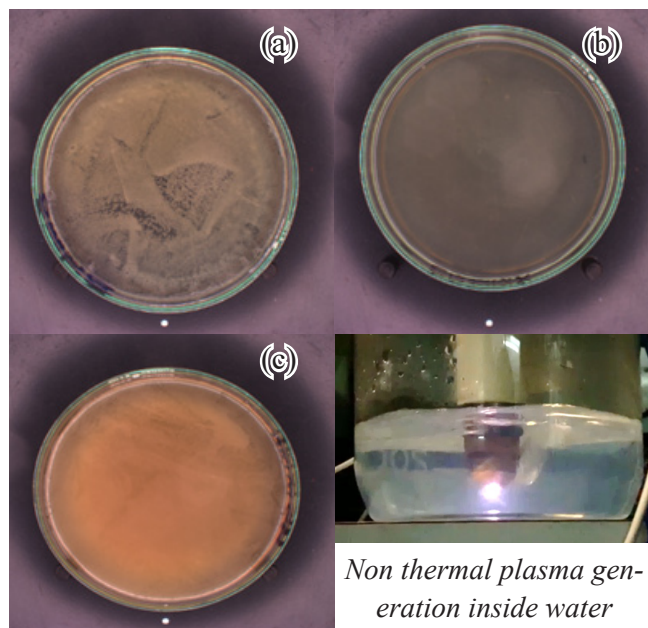

Figure A.3.3 : E-Coli bacterial growth at different interaction time duration between PAW and E-Coli Solution (a) 0 min, (b) 45 mins, (c) bacterial growth in untreated water

formed, interact with water during the exposure or after the plasma discharge is switched off. Plasma activated water is emerging field and has many applications in killing harmful micro-organism to cure various skin diseases and may eliminate the use of pesticides in agriculture. Studies suggest that plasma activated water possess reactive nitrogen species (RNS) which include nitrous (NO<sub>2</sub> -) and nitric (NO<sub>3</sub>-) and reactive oxygen species (ROS) such as peroxy radicals (.OOH) and hydrogen peroxide dissolved in water. Electrons get attached with oxygen species and assist in scavenging oxidation reactions. Recent research has shown that microbial cells can be killed when they are exposed to plasma activated water. IPR has developed a novel apparatus and process to produce activated water using non-thermal plasmas. The initial chemical analysis and microbial analysis has been carried out with the help of Gujarat Environment Management Institute (GEMI), Gandhinagar. E.Coli bacteria growth study in untreated and plasma activated water (PAW) was carried out at GEMI, Gandhinagar. The growth of E.Coli bacteria at different experimental conditions is shown if figure A.3.3. It was also observed that plasma induced chemical change in water is able to enhance sprouting behaviour in vegetables such as potato. One potato washed using tap water and the other one using PAW, the potato washed with PAW shows en-

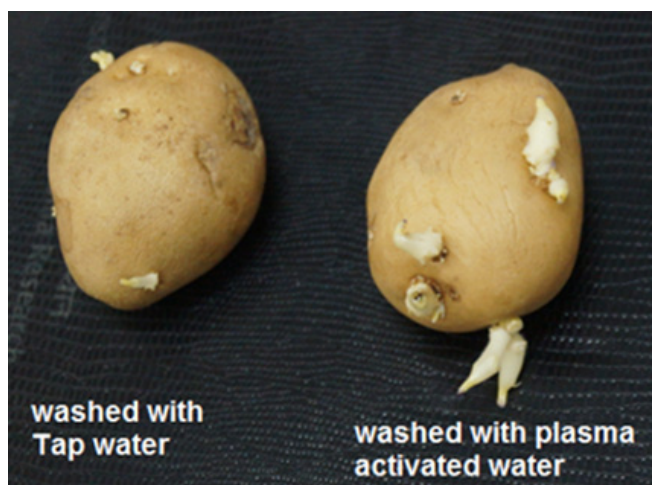

Figure A.3.4 Enhanced sprouting behaviour in potato washed using PAW compared to the one washed using normal tap water

hanced sprouting behaviour compared to the potato washed using normal tap water after 7 days of washing as shown in figure -A.3.4.

**FCIPT-TEX project (Funded by DST):** A MoU is signed between IPR Gandhinagar and Man Made Textile Research Association (MANTRA). In this project a power source has been developed capable to generate atmospheric pressure plasma across 2.5 meter wide electrode pairs. In this system textile material can be treated up to moderate line speed up to 60 meter per minute. Dielectric Barrier Discharge (DBD) plasma generation at atmospheric pressure across 2.5 meter wide electrode pair has been tested.

**A Novel Process For Improving The Service Life Of Agricultural Cutting Blades In North East Region:** Conventional plasma nitriding is a popular process for enhancing the life of the industrial components by improving the properties like surface hardness; wear resistance, fatigue strength and corrosion resistance. However, this process is not useful for sharp blades. This is because the sharp edges are brittle after plasma nitriding and break during cutting. In this study a novel process was developed to study the cutting performance of agricultural cutting tools using a hollow cage. A negative bias was applied to the hollow pipes and the blades were nitrided without applying any potential. These agricultural tools were sent for field trials to cut bamboo shoots in Nagaland. It was found that the cutting efficiency of the agricultural tools treated by this process was three times better than the untreated tools.

#### **Oxygen Barrier Coating for Food Packaging Applications:**

This project is about enhancement of oxygen diffusion barrier properties of polyethylene packaging web. Polyethylene is very economic packaging polymer with good mechanical and heat seal properties but is a very poor oxygen barrier material. Due to this reason it is always used with other polymer material as a multi-layer package. Recycling of multi-layer packaging material is almost of no use and hence single layer packaging material is preferred. SiO<sub>x</sub> coating using PECVD method has been deposited on polyethylene packaging material with different process parameters to enhance its oxygen diffusion barrier properties.

#### **Development Of CZTS Based Solar Cell Using Magnetron Sputtering:**

In this work CZTS (Cu<sub>2</sub>ZnSnS<sub>4</sub>) based solar cell is prepared using magnetron sputtering. First Molybdenum (Mo) layer is deposited on soda lime glass using DC magnetron sputtering followed by Cu, Zn, Sn layers by DC-Co-Sputtering. After this sulphurization is done in sulphur and Nitrogen mixture environment. After that a thin layer of CdS is deposited using Chemical Bath Deposition (CBD) method and then thin ZnO layer followed by ZnO: Al layer as Transparent Conducting Oxide (TCO) was prepared using RF-magnetron sputtering. 2% efficiency is achieved in solar cells prepared by this method.

#### **Materials Characterized Using Transmission Electron Microscope (TEM):**

A 300 kV FETEM was procured and installed at FCIPT, IPR. The TEM is FEI make and the model is Tecnai G2 F30. The instrument is equipped with EDX, STEM, and EELS accessories. The instrument can be used basically for high resolution imaging, crystallographic studies, defect identification & analysis, and also to obtain chemical information from nano sized particles and features. The instrument is being used regularly

--!!--

## A.4. Theoretical, modeling and Computational Plasma Physics

Plasma physics requires a very intense computational capability for its modelling and simulation program. The institute has developed a versatile computational facility in many years. At present work is being done in the the following heads:

A.4.1 Non-Linear Plasma Studies & Simulation .....	25
A.4.2 Laser Plasma Studies .....	27
A.4.3 Dusty and/or Complex Plasma Studies .....	27
A.4.4 Fusion Reactor Studies .....	28

### A.4.1 Nonlinear Plasma Theory & Simulation

**Effect of driving frequency on the electron energy distribution function and electron-sheath interaction in a low pressure capacitively coupled plasma:** By using a self-consistent particle-in-cell simulation, investigation of the effect of driving frequency (27.12–70 MHz) on the electron energy distribution function (EEDF) and electron-sheath interaction in a low pressure (5 mTorr) capacitively coupled Ar discharge for a fixed discharge voltage, has been carried out. It is observed that a mode transition occurs with driving frequency, changing the shape of EEDF from a strongly bi-Maxwellian at a driving frequency of 27.12 MHz to a convex type distribution at an intermediate frequency, 50 MHz, and finally becomes a weak bi-Maxwellian at a higher driving frequency, i.e., above 50 MHz. The transition is caused by the electric field transients, which is of the order of electron plasma frequency caused by the energetic “beams” of electrons ejected from near the sheath edge. Below the transition frequency, 50 MHz, these high energy electrons redistribute their energy with low energy electrons, thereby increasing the effective electron temperature in the plasma, whereas the plasma density remains nearly constant. Above the transition frequency, high-energy electrons are confined between opposite sheaths, which increase the ionization probability and therefore the plasma density increases drastically.

**Effect of weak static magnetic field on electron and ion dynamics in low pressure capacitive discharges:** Single fre-

quency capacitive discharge (CCP) with magnetic (B) field (parallel to electrode) is a more superior technique, to control ion energy and ion flux, compared to dual-frequency CCP. Later has limitation because either coupling in frequencies occurs (if lower and higher frequencies are too close) or electromagnetic effects appear (for  $>70\text{MHz}$  to rectify coupling effect). Electron and ion dynamics of helium plasma has been investigated by varying B with help of PIC simulation. The sheath width reduced  $\sim 80\%$  (control ion energy) and bulk density increases  $\sim 7$  times (increases ion flux) from . This asymmetry appears because of coupled diffusion of electrons/ions across magnetic field.

**Relativistic wave-breaking limit of electrostatic waves in cold electron-positron-ion plasmas:** A one-dimensional non-linear propagation of relativistically strong electrostatic waves in cold electron-positron-ion (EPI) plasmas has been analyzed. The motion of all the three species, namely, electron, positron, and ion has been treated to be relativistic. The maximum permissible electric field amplitude – so called “wave- breaking limit” of such an electrostatic wave before wave-breaking has been derived, showing its dependence on the relativistic Lorentz factor associated with the phase velocity of the plasma wave, on the electron/positron to ion mass ratio, and on the ratio of equilibrium ion density to equilibrium electron/positron density. Such studies are relevant for some astrophysical scenarios.

**Relativistic electron beam driven longitudinal wake-wave**

**breaking in a cold plasma:** Space-time evolution of a relativistic electron beam driven wake-field in a cold, homogeneous plasma is studied using 1D-fluid simulation techniques. It is observed that the wake wave gradually evolves and eventually breaks, exhibiting sharp spikes in the density profile and sawtooth like features in the electric field profile. It is shown here that the excited wakefield is a longitudinal Akhiezer-Polovin mode and its steepening (breaking) can be understood in terms of phase mixing of this mode, which arises because of relativistic mass variation effects. Further, the phase mixing time (breaking time) is studied as a function of beam density and beam velocity.

**Phase Mixing of relativistically intense longitudinal wave packets in a cold plasma:** Phase mixing of relativistically intense longitudinal wave packets in a cold homogeneous unmagnetized plasma has been studied analytically and numerically using the Dawson Sheet Model. A general expression for phase mixing time as a function of amplitude of the wave packet and width of the spectrum has been derived. It is found that the phase mixing time crucially depends on the relative magnitude of amplitude and the spectral width. Theoretically derived dependence of phase mixing time on the amplitude and spectral width of the wave packet has been verified using numerical simulations based on the Dawson Sheet Model.

**One dimensional PIC simulation of relativistic Buneman instability:** Spatio-temporal evolution of the relativistic Buneman instability has been investigated in one dimension using an in-house developed particle-in-cell simulation code. Starting from the excitation of the instability, its evolution has been followed numerically till its quenching and beyond. The simulation results have been quantitatively compared with the fluid theory and are found to be in conformity with the well known fact that the maximum growth rate of the instability reduces due to relativistic effects. Further it is observed that in contrast to the non-relativistic results at the saturation point, the ratio of electrostatic field energy density to initial drift kinetic energy density scales inversely with the square of the Lorentz factor. This novel result on the scaling of energy densities has been found to be in quantitative

agreement with the scalings derived using fluid theory.

**Impact of particle trapping undamped coherent structures on stability of collisionless plasma:** An outstanding notion for collisionless plasmas is the essential nonlinear character of its coherent structures, which in the stationary, weak amplitude limit are described by a continuum of cnoidal electron and ion hole modes being governed by a multiparametric nonlinear dispersion relation. The well-known discrete structure of undamped linear plasma modes is seamlessly embedded in this nonlinear continuum, as the microscopic texture of plasma begins to show itself up in the high temperature collisionless plasma limit. This transforms the linear-threshold-based operating mechanism of the plasma turbulence into a fundamental nonlinear, multifaceted one. Based on a comprehensive three-level description of increasing profundity that unifies discrete and continuum limits by resolving the inevitable resonant region, it is shown that coherent electrostatic equilibria are generally controlled by kinetic particle trapping and are hence fundamentally nonlinear. Forging a link between damped and growing wave solutions they render plasma stability complicated and difficult to seize due to the entangled pattern of the stability boundary in function and parameter space, respectively. A direct consequence of this is the failure of linear Vlasov approach in describing these coherent waves whenever resonant particles are involved. The breakdown of linearity and hence of Landau approach together with the necessity of incorporating nonlinear particle trapping effects constitutes a new, big challenge for stability theory to establish something like a single, Landau-like stability criterion, being independent of microscopic, initial conditions, that grasps deviations from marginal stability in both directions, damping and growth. High resolution, exact-mass-ratio, multispecies, collisionless plasma simulations are employed to illustrate exemplarily how tiny seed fluctuations in phase-space can act as a triggering agent for a subcritical plasma excitation involving these modes.

**Collective dynamics of time-delay-coupled phase oscillators in a frustrated geometry:** Many complex networked systems in nature relax in arrangement where their individual elements like to stay in opposite state from the elements they

are coupled to. A uniformly frustrated population is expected in a system where each element is coupled to more than one mutually coupled elements. However, a uniform frustration is often inaccessible and clusters of synchrony are present. We show that in such complex systems a complete synchrony can be achieved by introducing a time delay in the communication between elements. We study the effect of time delay on the dynamics of a system of repulsively coupled nonlinear oscillators that are configured as a geometrically frustrated network where each oscillator likes to be asynchronous to its neighbour. In the absence of time delay, this frustrated system is known to possess a high degree of multistability between a large number of coexisting collective states, except for the fully synchronized state that is normally obtained for attractively coupled systems. Time delay in the coupling is found to remove this constraint and to lead to a globally synchronized ground state over a range of parameter values. A quantitative study of the variation of frustration in a system with the amount of time delay has been made and a universal scaling behaviour is found. The variation in frustration as a function of the product of time delay and the collective frequency of the system is seen to lie on a characteristic curve that is common for all natural frequencies of the identical oscillators and coupling strengths. Thus time delay can be used as a tuning parameter to control the amount of frustration in a system and thereby influence its collective behaviour. Our results can be of potential use in a host of practical applications in physical and biological systems in which frustrated configurations and time delay are known to coexist.

#### A.4.2 Laser Plasma interaction studies

**Molecular dynamics simulations of laser-driven atomic cluster:** Anharmonic resonance (AHR) absorption of laser light is known to occur when the time-dependent frequency of a laser driven electron in the anharmonic electrostatic potential of a cluster becomes equal to the laser frequency. However, this mechanism is still a matter of debate. To examine AHR a three dimensional Molecular Dynamics (MD) code has been developed. We have studied multi-particle dynamics of the ionized cluster with electrons (e) and ions (i) interacting (with e-e, e-i, i-i interactions) via Coulomb

potential. The pure Coulomb potential being singular (when two particles are very close), it leads to unphysical energy gain. The Coulomb singularity is mitigated using a soft-core Coulomb potential. It is found that only certain values of this soft core parameter close to the Wigner-Seitz radius lead to correct Mie-plasma frequency and correct plasma oscillation for a spherical system. Detailed studies on the absorption of laser light in deuterium clusters have been carried out which clearly show anharmonic resonance process is the dominant mechanism.

**Effect of laser wavelength on the laser absorption and ionization of clusters:** Laser-cluster interaction experiments earlier have demonstrated enhanced absorption of laser pulses when the Mie-plasma frequency of the expanding cluster resonates with the laser frequency. However, controversial results exist in the literature where role of above linear resonance was absent, thus violating the physical basis of the plasma resonance. In this work, we study the impact of laser wavelength on the absorption of short laser pulses irradiating a deuterium cluster by three dimensional molecular dynamics (MD) simulations. Results show that, for a given pulse energy, in the low intensity regime  $< 10^{15}$  W/cm<sup>2</sup>, there exist a wavelength at which cluster absorbs maximum energy accompanied by maximum outer-ionization of electrons due to the linear resonance that occurs at the early stage of the cluster expansion. As the intensity increases the maxima in the absorption curve and in the outer-ionization grow together but shift towards higher wavelengths and above a certain value of the laser intensity  $> 5 \times 10^{16}$  W/cm<sup>2</sup> the absorption maximum disappears when outer ionization saturates at 100%. Detailed studies are being carried out to understand the simulation results. In the next step we plan to incorporate self-consistent ionization mechanism for rare-gas clusters (e.g., Ar, Xe) and subsequent effect of laser wavelength on the ionization

#### A.4.3 Dusty plasma/ Complex plasma studies

**Nonlinear effects in the bounded dust-vortex flow in plasma:** The vortex structures in a cloud of electrically suspended dust in a streaming plasma constitutes a driven system that allows examining fundamental characteristics of many com-

plex systems surviving away from the thermodynamic equilibrium. Experimentally recovered toroidal formations of this system have motivated study of its volumetrically driven-dissipative vortex flow dynamics using two-dimensional hydrodynamics in the incompressible Navier-Stokes regime. Nonlinear equilibrium solutions are obtained for this system where a nonuniformly driven two-dimensional dust flow exhibits distinct regions of localized accelerations and strong friction caused by stationary fluids at the confining boundaries resisting the dust flow. In agreement with observations in experiments, it is demonstrated that the nonlinear effects appear in the limit of small viscosity, where the primary vortices form scaling with the most dominant spatial scales of the domain topology and develop separated virtual boundaries along their periphery. This separation is triggered beyond a critical dust viscosity that signifies a structural bifurcation. Emergence of uniform vorticity core and secondary vortices with a newer level of identical dynamics highlights the applicability of the studied dynamics to gigantic vortex flows, such as the Jovian great red spot, to microscopic biophysical intracellular activity

#### A.4.4 Fusion Reactor Studies

India's energy demands are rising rapidly and to meet the future requirements, DEMO development strategy is planned. In the Indian scenario, Steady State Superconducting Tokamak-2 (SST-2) is an intermediate machine on the pathway of DEMO development. The main objective of SST-2 is to develop a D-T fusion reactor to test and qualify the proposed developmental activities for reactor. This machine will allow us to gain experience similar to ITER but there are other major advantages. First of all, it will allow an integrated test of indigenously developed technological components like breeding blanket, He cooled divertor, etc. It is planned to perform an integral test by covering the out-board side of SST-2 with breeding blanket while the in-board side with shielding blanket. This will simulate the blanket operation of DEMO reactor and will give feed-back to modify the design of DEMO if needed. Secondly, it will create the pool of experienced manpower, both within the national network of organizations and within the industry, which is crucial for build-

ing the DEMO. SST-2 design and performance analyses for preconception phase are under progress. Aspect ratio studies were done for SST-2 by checking the effect of increasing the aspect ratio (ratio of major to minor radius of the Tokamak). The study was performed as the current aspect ratio of SST-2 did not provide the required discharge duration for SST-2 due to the smaller space available for the Central Solenoid (CS). Increasing the aspect ratio increases the pulse duration, but decreases the fusion output. Based on the aspect ratio studies, physics parameters were generated for SST-2 for different aspect ratios.

**Reactor Design:** Conceptual design of SST-2 vacuum vessel is under progress. Engineering requirements and design basis with the identified thermal, seismic and structural loads on the double walled 'D' shaped vacuum vessel for SST-2 were assessed. Parametric modelling of VV as a 2D surface geometry modelled in CAD environment, while the actual thickness of shell and ribs were defined at the time of FEM sensitivity analyses. The preliminary assessment of the impact of these events has been performed on the structural margins calculated to guarantee the Vacuum Vessel's structural integrity with regards to the ASME and RCC-MR codes. Prediction of welding distortion and optimization of manufacturing sequence of VV, computational simulations were carried out considering multiple factors like process, weld parameters, geometry, type of joint, sequence, clamping conditions, welding direction, thermal, metallurgical, mechanical material behaviour and the local-global approach. The magnets of SST-2 will be superconducting in nature to have steady state operation of plasma. The Toroidal Field (TF) coils required to confine the plasma are eighteen in number. Poloidal Field (PF) coils are required to shape the plasma. TF coils with allowable maximum field (BTmax) at the conductor  $\sim 12$  T are considered with ripple of less than 0.03%. The poloidal field (PF) coils along with central solenoid (CS) will provide volt-sec to initiate and sustain ohmic plasma. The CS and PF coils of SST-2 consists of three pairs of modules and three pairs of top-down symmetric coils which are considered for plasma equilibrium. The estimated volt-sec capability of CS coil for magnetic field of 12 T is  $\sim 50$  Wb, which can be doubled with negative convertor operation. Additional volt-sec of  $\sim 26$  Wb



has also been estimated from PF coils using VMOM code.

**Nuclear analyses :** This plays a key role in the design of fusion reactors. Nuclear analyses of SST-2 were carried out to assess the shielding performance and tritium breeding capabilities. A modified radial build has been prepared and its nuclear analyses have been carried. Nuclear analyses of this modified radial build have been carried to assess the tritium breeding performance and shield capability for 5 FPY. The neutronics and shielding calculations reported herein were performed using the one-dimensional discrete-ordinates code, ANISN with the P5-S8 approximation and the FENDL-2.1 cross-section library in the 46n-21g group structure. The SST-2 reactor geometry was modeled by using a toroidal cylindrical model with height of 1 cm. IB and OB components are modeled as concentric cylindrical rings with the plasma chamber in between, and the torus axis as the model symmetry axis. The 14 MeV source neutrons are uniformly distributed in the cylindrical plasma ring with the scrape-off zones of 9 cm each on IB and OB. The reflective boundary condition has been applied at the torus axis as one half of the geometry has been used in the calculation. In this way the 1-d geometry of the SST-2 model is simulated in the ANISN calculation. In each zone the materials are homogeneously mixed for the neutronics calculations. Coupled neutron/gamma calculations have been carried out to obtain the spatial and energy distribution of neutron and gamma-flux, the tritium breeding ratio (TBR) and radiation loads to TF coil. Two breeder blanket concepts have been considered as options for the SST-2 reactor. The primary blanket concept is Lead-Lithium Ceramic Breeder (LLCB) blanket and the other is a conventional Helium-Cooled Ceramic Breeder concept (HCCB) with variance in geometrical design. The nuclear performance of these two concepts has been evaluated by placing them in the outboard breeder blanket region of SST-2 reactor. The radial profiles of neutron and gamma fluxes have been obtained both in the IB and OB of the SST-2 reactor

--!!!--

## CHAPTER B

### Activities of ITER-India

In the past one year ITER-India made significant progress in the ITER project. During this period, the ITER-India project has entered into the manufacturing for few packages. The details of the activities completed under different packages/heads are given below.

#### B.1 In-Wall Shielding (IWS)

The In-Wall Shielding (IWS) blocks shall be placed between outer and inner shells of ITER Vacuum Vessel (VV) which is a double wall structure. The main function IWS is to stop escaping the neutrons and to reduce the toroidal magnetic field ripple. These shielding blocks are made of SS 304B4, SS 304B7, SS 430 and SS 316L (N)-IG and Fasteners (Bolts, Nuts, Spacers, Washers etc.) are made from XM-19 and Inconel-625. The manufacturing of IWS blocks is in progress at Avasarala Technologies Ltd. Bangalore. Rigorous Factory Acceptance Tests (FAT) of (i) IWS blocks, (ii) Support Rib + Lower Bracket welded and machined assemblies, (iii) Platforms and (iv) Studs, to check actual assembly issues were carried out. Dimensional inspection, assembly of IWS blocks with different shapes and high accuracy and vacuum packing for high cleanliness during transportation and storage



Figure B.1 In-Wall Shielding Block Assemblies – manufactured and being readied for testing

were carried out. At every stage of production several technical challenges were addressed. Large numbers of blocks and components have been successfully manufactured, assembled, inspected, packed and shipped to Europe and Korea where it will be further integrated in the vacuum vessel sectors. Fabrication and factory acceptance tests of rest of blocks and field joints are in progress.

#### B.2 Cryostat

The ITER Cryostat, to be the largest stainless steel vessel of its kind provides the high vacuum pressure ever built (16,000 m<sup>3</sup>)—provides the high vacuum, super-cool environment for the ITER vacuum vessel and the superconducting magnets. Nearly 30 metres each in diameter and height and manufactured from stainless steel, the cryostat weighs 3,850 tonnes. The Cryostat will be manufactured in about 54 pieces that will form 4 main sections – Base Section, Lower Cylinder, Upper Cylinder and Top Lid. The base section—1,250 tonnes—will be the single largest load of ITER Tokamak assembly. Manufacturing of ITER Cryostat components is progressing at Larsen & Toubro Heavy Engineering, Hazira, Gujarat. Fabrication of Tier-2 components of Cryostat Base section was completed, followed by successful inspection & trial assembly at the manufacturer site. The 6 sectors (total weight approx. 720 tons) were shipped from Hazira port and delivered to the ITER site in two shipments of 3 sectors each in June 2016 and October 2016. Fabrication of Lower Cylinder Tier-1 (total weight approx. 240 tons) was completed



Figure B.2 Cryostat Base Section Tier-1 welding and testing at ITER site workshop

and shipped from Hazira port during January 2017 and delivered to ITER site in March 2017. At the Cryostat workshop at ITER site, welding and testing activities progressed for Base Section Tier-1.

### B.3 Cooling Water system

Certain ITER systems/components will be working on specific temperature during the operation, this temperature is needed to be kept in the required margins. Cooling water system is needed to take away heat from the various components/systems and reject this in to the atmosphere. Piping fabrication progressed further and approx. 600 pipe spools were delivered to ITER site. The Ozonation System was delivered to ITER site. Manufacturing Readiness Reviews were conducted for several equipment like Cooling Tower, Stop Log Gates, Plate Heat Exchangers, Pressurizer, Chemical Dosing System, Plant Control System, Water-Cooled Chillers & Soft Starter. Successful Factory Acceptance Tests were conducted for 6 Plate Heat Exchangers and 4 Chillers at the manufacturer facilities (Kelvion and Kirloskar respectively) in Pune. Soft Starters for the Chillers were also successfully tested at the manufacturer premises (Solcon) in Israel and combined testing of Chiller and Soft Starter was done successfully at Pune. The items are being readied for packing and shipment to ITER.

### B.4. Cryodistribution & Cryolines

Prototype Cryoline (PTCL-2) manufacturing was completed and was received at ITER-India cryogenics laboratory at IPR, where it was installed and provisional as well as final

acceptance tests at cryogenic temperatures were successfully completed. Seven design reviews and three manufacturing readiness reviews of various lots of ITER Cryolines have been successfully completed, while three design reviews of various lots of ITER Warmlines have been successfully completed. Manufacturing and testing of Lot-Y1 Cryolines is in progress at INOX India Ltd. while manufacturing of Lot-X3 Cryolines is in progress at Air Liquide, France. For Cryodistribution system, final design of Cryoplant Termination Cold Box (CTCB) has been completed. Manufacturing Readiness Reviews have been completed for CTCB components like vacuum shell, cryogenic valves, internal piping, thermal shield, electrical cubicles, cryogenics filters, heaters and vacuum barrier/sleeves. Manufacturing has been completed for vacuum shell of CTCB with vacuum barrier, filter and heater casing. Preliminary design review of all Auxiliary Cold Boxes (ACBs) and Thermal Shield Cooling System has completed. Detail design of ACBs is ongoing.

### B.5. Ion Cyclotron Heating & Current Drive Sources

One of the important auxiliary heating and current drive methods for ITER plasma is by using radio frequency waves in the Ion Cyclotron Resonant Frequency (ICRF) range. Total 20 MW of ICRF power will be launched using 8 nos. of sources, each unit of having 2.5 MW/Continuous Wave (CW) capabilities, a Prototype unit is also included in this package for demonstrating the technology. India is responsible for supplying total 9 (1 Prototype and 8 series production) complete ICRF sources for ITER project. To identify the best high power vacuum tube (Diode/Tetrode) and other criti-



Figure B.3 Ozonation System delivered to ITER site



Figure B.4 Cryoplant Termination Cold Box (CTCB) Vacuum Shell

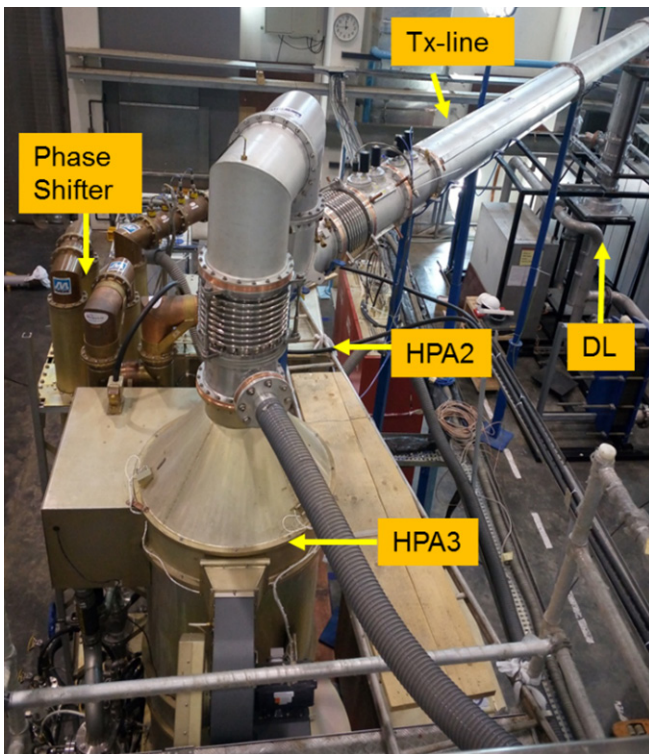

Figure B.5 Tetrode Based System at ITER-India lab

cal components for ITER application, an R&D program has been initiated. Two major contracts have been launched with Thales Electron Devices, France for Diacode technology and with Continental Electronics Corporation, USA for Tetrode technology, to finalize technical choices of vacuum tube technologies for final stage amplifier. 3MW test rig simulating mis-match load condition has been developed at ITER-India test facility. For Diacode based system, Burn test was conducted for 6000s to verify the ruggedness of the entire system & benchmark the technology for fusion application. Mis-Match Transmission Line (MMTL) system was installed with Diacode based RF amplifier for conducting ITER like test scenarios and was tested at 1.5MW / 2000 s/35-65MHz with VSWR 2:1 at various reflection angles. These tests essentially ensured constant IC power to the ITER plasmas even with mismatch situation, for example, mismatch condition due to appearance of Edge Localized Modes (ELMs). During this reporting period, R&D activity using Diacode based system completed successfully. Tetrode based Amplifiers have been assembled and integrated with auxiliaries & other sub-systems at ITER-India test facility. Initially high power RF test conducted on matched load at lower frequency side (36 MHz) of the operating frequency range and tested up to 1.5 MW/ 2000 seconds and 1.7MW/3600 seconds

with required bandwidth (+/-1 MHz) successfully. At other operating frequencies (45 MHz, 50 MHz, 55 MHz and 60 MHz), up to 1MW of RF power could be extracted for several 100 seconds. Further testing as per ITER specification is ongoing. Expertise has been developed in high power RF design and fabrication methodology. Directional Coupler and Flexible Transmission Line were developed and tested for 1.5MW/2000 sec/35-65MHz. Wideband combiner was developed and tested for its functionality at kW level. Solid State Power Amplifier has been tested at 1.6 kW/CW and up-gradation of power is underway.

## B.6. Electron Cyclotron Heating (ECH) system

ITER requires 20 MW of RF power at Electron Cyclotron frequency (170 GHz) for Plasma Heating and Current Drive applications. As a part of in kind contributions to ITER project, ITER-India has a procurement package that includes delivery of two sets of High Power Gyrotron sources (170 GHz/1MW/3600 s) and auxiliary systems to ITER. The procurement package is being executed in two phases. In phase-1, a gyrotron test facility is being established at ITER-India, in IPR campus to enable the system integration and integrated performance testing of the deliverables with the help of a Test Gyrotron and prototype auxiliary systems. In phase-2 the actual ITER deliverables will be taken up. Currently the Phase-1 activities are being actively pursued. Following are some of the main progress highlights carried out during the current year. Towards the auxiliary systems for the gyrotron test facility, various developmental and procurement activities have been carried out. Contract has been placed to establish a large volume cooling distribution system for the Gyrotron test facility. A cost effective and modular solution using high voltage solid-state switches has been considered for prototype development to meet the high frequency mod-

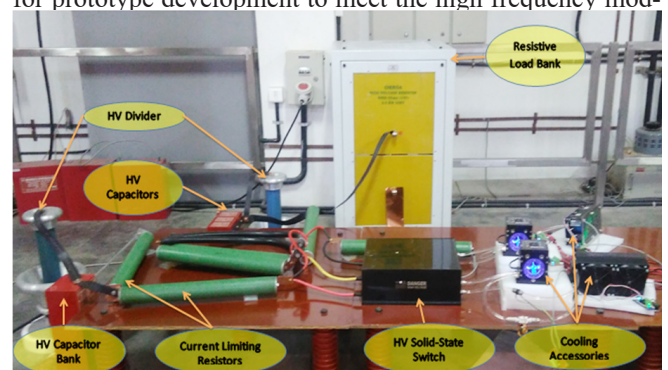

Figure B.6 Experimental Test Setup with Initial Test results of Gyrotron Body power supply

ulation requirement for the Gyrotron Body Power Supply (35kV/100mA/5 kHz). R&D for the same is in progress. First phase of testing was successful and results achieved were satisfactory. Further testing at enhanced parameters has been initiated. Towards development of Local Control Unit for the Gyrotron test facility few design and development activities have been carried out. A prototype industrial grade centralized Interlock Module has been developed indigenously. Functional and EMC/EMI qualification tests have been carried out with satisfactory results. Indigenous development trials for prototype corrugated waveguide (63.5mm) has been initiated. After several trials, the machining process has been optimized to produce the accurate corrugations within the waveguide section of about 300 mm length. In the context of ITER project a phased development roadmap for an indigenous Gyrotron design & development program at 170GHz has been worked out under a MoU with CSIR-CEERI.

### B.7. Diagnostic Neutral Beam (DNB)

The Diagnostic Neutral Beam (DNB) (3 Seconds ON/20 Seconds OFF with 5 Hz modulation) in ITER is mandated to provide 100 kV, ~18-20 Amperes Hydrogen beam to support the Charge Exchange Recombination Spectroscopy (CXRS) for the measurement of Helium ash in the ITER machine.

**Beam Source manufacturing:** At the manufacturer M/s PVA TePla, Germany and their sub-contractors, almost all the major components of DNB Beam Source (accelerator grids, grid support flanges and frames, plasma driver plate, source case

lateral walls, RF coil, faraday shields rear driver plate. Electron dump etc.) are under manufacturing. The manufacturing involves complexity in terms of material, welding, precision requirements and these are being addressed by using advanced technologies like deep-hole drilling, electron beam welding, copper electro deposition and precision machining. Upon completion of manufacturing in a year, acceptance tests would be carried out at factory as well as site prior to installation at INTF test bed.

**Beam Line Components manufacturing:** Manufacturing activities of Beam Line Components has been initiated by the manufacturer PVA TePla Germany and their subcontractors. Major raw material for manufacturing of Neutralizer panels & stainless steel has been procured. CuCrZr Raw material for manufacturing of RID Panels & Heat Transfer elements has been supplied by M/s NFTDC, Hyderabad. Other critical processes like deep-hole drilling of RID panels & Neutralizer panels have been successfully established. Electron Beam (EB) Weld qualification trials is ongoing to weld various similar & dissimilar material combination for manufacturing of Neutralizer, RID Panels & water cooling circuit.

**Data Acquisition and Control System (DACS) for Indian Test Facility (INTF):** To support INTF operations DACS is presently in advanced stage of design and implementation. Major hardware procurements related to control, data acquisition and signal conditioning have been completed. Development of data acquisition for long pulse upto 3600 sec has been completed. New technologies related to timing and synchronization system have been tested and integrated.

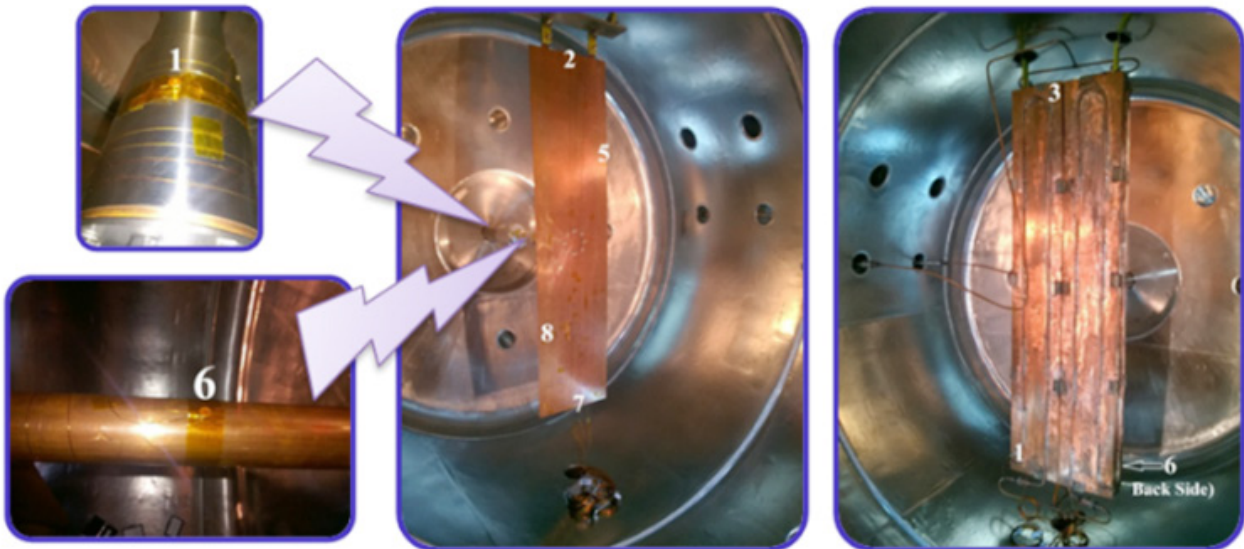

*Figure B.7 Cryocooler based Cryopump experiment*

**RF Power Experiment in Vacuum:** To mimic the RF operation in vacuum and to know the temperature rise of the 3 1/8 inch RF line for 180kW 1MHz RF power a setup is prepared. All the components (installed on the flange) are individually tested for vacuum. Vacuum of the order of 0.0088 mbar is achieved. Achievement of higher order of vacuum through Diffusion pump is under progress.

**Cryocooler Based Cryopump Experiment:** An experimental validation of the temperature distribution on the Helium section has been carried out on a prototype using a 20 W @ 15 K Cryocooler. The cryocooler experiments have been performed using a LN2 cooled radiation shield in vacuum vessel. In vacuum chamber the vacuum of the order of  $\sim 5 \times 10^{-4}$  mbar are maintained. The prototype experiment indicates temperature profile on the cryopanel surface, cooled by a single cryocooler is sufficient for an efficient Cryosorption pump suitable for INTF operation.

**Manufacturing of Cryopump Module LN2 Section (Radiation Shield):** Each Cryopump consists of Liquid Nitrogen (LN2) cooled 210 V-shaped chevron baffles arranged in staggered way precisely as radiation shield around cryocooler cooled activated charcoal coated Cryopanel. The Chevron baffles are made of OFHC which are coated black with a  $\sim 50\mu\text{m}$  thick material ( $\text{Al}_2\text{O}_3 - \text{TiO}_2$ ) having high absorptivity and emissivity. All the baffles are stacked on one over the other using spacers and then vacuum brazed to (Liquid Nitrogen) LN2 pipes. Around 80% of chevron baffles have been black coated and vacuum brazing of chevron baffles with LN2 pipes have been initiated.

## B.8. Power Supply Developments

Power Supply Group is responsible for design, development and supply of various High Voltage Power Supplies (HVPSs) for DNB, ICH&CD and ECH&CD system of ITER, France and for SPIDER experiments at Neutral Beam Test Facility, Padova, Italy. The group is responsible to support R&D for the same systems at ITER-India lab and is also engaged in developing Indian industry for their participation in ITER and similar programme, including prototype efforts. Manufactured components of SPIDER Acceleration Grid Power Supply (AGPS) have been delivered to Neutral Beam Test facility, Padua, Italy. Installation and integration activities including standalone tests for AGPS components have been carried out; integrated testing is ongoing. AGPS for DNB has been installed and being tested at ITER-India (II) Lab. As a part of R&D programme at ITER-India lab, solid state high

frequency (1 MHz) power source has been developed; the source is interfaced with plasma load and tested successfully at ITER-India (I-I) lab. A motorized short circuit switch is developed in-house for high voltage application; specifically for wire burn test of HVPS. 300 kHz analogue optical link is developed for HVPS voltage and current measurement with optical isolation. The units are being used for AGPS at ITER-India lab. After successful testing of prototype at I-I lab, segments of 25m transmission line including two horizontal bends and one vertical bend are manufactured at Shell N Tube, Pune. Components are tested at sub-assembly level and ready for dispatch. High voltage deck for DNB power supply system is manufactured and installed at lab. Industrial prototype IC HV power supply is being operated continuously for site acceptance campaigns of ICRF sources diacode and tetrode based systems.

## B.9. Diagnostics

**X-Ray Crystal Spectrometer - Survey System:** First phase of Preliminary Design Review of XRCS-Survey sight tube was completed. Further progress was made on technical activities including fire analysis, RAMI and HIRA analysis, integration with respective ports, integrated structural and neutronic analysis. For laboratory R&D experiments, most of the components for conventional X-ray source and optical setup required for testing curved diffractors are received and tested. The fixed anode x-ray source was assembled and integrated with vacuum system, power supplies, temperature monitors. The filament testing has been completed and progressing with operation for measuring x-ray beam spectrum and dose. The measurement of X-ray fluorescence was done and elemental concentration was found. The maturity of the Plant Instrumentation & Control design was assessed and the results showed fairly good level of functional analysis and operation procedures.

**Electron Cyclotron Emission (ECE) diagnostic system:** The preliminary design of this system and prototype works are progressing. Fast scanning Fourier Transform Spectrometer (FTS) has been delivered to ITER-India lab after successful completion of Factory Acceptance Tests at the manufacturer site (Bluesky, Canada). Transmission line components (5 pieces of straight WG sections each of length 2m, 3 Miter bends, 2 waveguide pump out tees) and window assembly were received, assembled and tested. The polarizer splitter unit was designed and analyzed for both prototype and ITER deliverables. Highly symmetric output beam waists with  $>99\%$  power coupling into the fundamental beam mode was



observed. Quasi-Optical Notch Filter was designed and analyzed for protection of ECE diagnostic from high power stray radiation coming from ECRH at 140 GHz.

**Charge Exchange Recombination Spectroscopy (CXRS):** This system along with Beam emission spectroscopy (BES) provides impurity (He, Be, Ne, Ar, C) density information. Preliminary performance assessment of CXRS & BES diagnostic system for ITER pedestal region has been carried out to assess the ITER measurement requirements.

**Upper Port Plug:** First phase of System Integration Review for Upper Port integration is completed. Integration with the interfacing diagnostics and their requirements in the port plug are developed. Load specification report, Electromagnetic analysis, shutdown dose rate calculations, remote handling capability assessment are in progress while RAMI analysis for the preliminary design review is completed.

## B.10. Activities of Fusion Physics Group

Modelling of disruptions in DIII-D and CMOD tokamaks for characterization of Halo currents during disruption and predictions for ITER - this work was started in early 2014 and has been completed in 2017. Integrated Modeling and Analysis Suite (IMAS) is a platform based on Kepler, where different tokamak related codes can be integrated elegantly. IMAS has been successfully implemented on ITER-India Servers. A model is developed to simulate the generation, diffusion and the mitigation through magnetic perturbations of runaway electrons in tokamaks. The code is planned to use for ITER calculations, and a possibility of coupling the same with NOTEC to understand its implications on ECE diagnostics. A zero-dimensional (0-D) model has been developed that consists of five temporal equations: the electron and neutral density equations, the electron and ion energy density equations, and the electric circuit equation. The primary aim of this work is to couple the 0-D code with TSC for modeling the plasma discharge scenario of tokamaks. A model is developed to calculate loop voltages at all flux loop locations & eddy current in passive structures (Vacuum vessel & Cryostat). It has been used for comparing flux loops and magnetic probe data of various SST-1 and ADITYA-U experimental shots.

## B.11. Activities common to all packages and project office

Regular schedule updates were made and reported at ITER International organization. Ensured compliance to Quality Management System through various documents (Quality plan, Manufacturing & Inspection Plans, Procedures etc.) reviews. Adherence to modern international project management practices and also implementation of Intellectual Property Management (IP) activities through pre-screening of publications for IP and implementing IP provisions in contracts with industry. Participation in Risk Management activities that included updating the project risk register and mitigation plans. Reporting of the developments to the public was also done through ITER Newline and ITER Annual Report.

**Neutronics group activities:** Three state of art codes and few visualization techniques are developed: 1. ACTYS- fast and accurate activation solver for a point in material, 2. ACTYS-1-GO fast and accurate activation solver for entire machine in a GO!, 3. METTA – A code for optimizing nuclear materials, for those expected to be in intense neutron irradiation (Added to ACTYS and ACTYS-1-GO. Separate module for FISPACT). Visualization techniques have been developed using Python added to ACTYS family or can be used independently.

## B.12. Activities of ITER-India Design Office

CAD and engineering support provided to technical groups of ITER-India. Fifty five Designs data (Data Exchange Task) were executed between ITER Organization, ITER domestic agencies and Suppliers and also provided associated technical support. Technical (Design and Analysis) and training (CAD, FEA) support provided to designers. Independent verification by Analysis on components like Valves, Pumps, Heat exchangers and chillers has been carried out. Thermo-hydraulic Analysis of Purge lines of ITER Cryogenics system and Transient Thermal analysis of Tungsten-copper Composite block have been carried out. Development of FE based Mathematical model for hinge support of vacuum vessel and analysis for flexibility performance was done. Design data preparation for Rectangular Bellows for external pressure condition based on EJMA and qualification procedure using the Finite Element method. Co-ordination in implementing the project changes via Configuration Control Board and participation in other working groups on document management, project lifecycle management and CAD.

--!!!-

## CHAPTER C, D & E

### C. Academic Programme

C.1 Doctorate Programme .....	37
C.2 Technical Training Programme .....	37
C.3 Summer School Programme.....	37

### D. Technical Services

D.1 Computer Services .....	37
D.2 Library Services.....	38

### E. Publications and Presentations

E.1 Articles Publications .....	39
E.2 Internal Research and Technical Reports .....	64
E.3 Conference Presentations .....	75
E.4 Invited Talks Delivered by IPR Staff .....	95
E.5 Talks Delivered by Distinguished Visitors at IPR.....	99
E.6 Colloquia Presented at IPR .....	101
E.7 Scientific Meetings Hosted by IPR .....	102
E.8 MoU Signed .....	104
E.9 Technology Transfers.....	105

## C. ACADEMIC PROGRAMMES

### C.1 DOCTORATE PROGRAMME

In the Ph.D. programme conducted by the institute forty two (42) research scholars have been enrolled at present. Out of them, seventeen (17) are working in theoretical and simulation projects while fourteen (14) are engaged in experimental projects. Eleven (11) new students have joined this programme during the year and are going through the course work. After successful completion of this course work, they will be enrolled for their Ph.D. Presently twenty five (25) Post-Doctoral Fellows are engaged in their research work.

**Ph.D. Thesis Submitted** (during April 2016 - March 2017)

Collective Phenomena in Strongly Coupled Dusty Plasma Medium

*Vikram Singh Dharodi*

Homi Bhabha National Institute, 2016

Slow Wave Characteristics of Metamaterial Loaded Helical Guide

*Dushyant Kumar Sharma*

Homi Bhabha National Institute, 2016

Nonlinear Excitations in Flowing Complex Plasmas

*Surabhi Jaiswal*

Homi Bhabha National Institute, 2016

Study of Er<sub>2</sub>O<sub>3</sub> Film Deposition by Different Techniques for the Fusion Reactor Applications

*Pratipalsinh A. Rayjada*

Sardar Patel University, 2016

### C.2 TECHNICAL TRAINING PROGRAMME (TTP)

There were three candidates in TTP-2016, two from Physics and one from Mechanical branch. They have undergone a rigorous coursework in plasma science and technology and completed their project work. After their successful completion of coursework, they were absorbed into various projects of IPR.

### C.3 SUMMER SCHOOL PROGRAMME (SSP)

Forty six (46) students participated in this programme, which

aimed at providing an opportunity to (28) students from M.Sc. Physics and (18) students from Engineering discipline which include Mechanical, Electronics and instrumentation, Electrical, Chemical and Metallurgy, to interact actively with scientists of the institute and learn about Plasma Physics and related areas through a project and series of lectures. Besides the above-mentioned training programme, project works are routinely offered in Computer, Electronics and Electrical Engineering for regular students as a part of their academic requirements.

## D. TECHNICAL SERVICES

### D.1 Computer Services

***IPR Data Center:*** The state-of-the-art data center at IPR is now operational. Spread over an area of ~95 sq. meters, this 14 rack facility with in-rack cooling and many levels of protection will cater to the current and future computing / IT needs of IPR. To support this facility, a dedicated cooling system as well as a robust UPS system, both with backups have also been established. The health of the racks and other support systems can be remotely monitored to ensure a 24x7 operation of the data center. The main features of this Data center are ; (a) Complies with the TIER 3 international standard (ANSI/TIA-942 standard) (b) Installed modular



UPS of 250kW capacity (125KW in N+N mode), upgradable to 400KW (c) Two air cooled scroll chillers (60TR capacity each) functioning in N+N mode (d) In-rack cooling system (Liquid Cooling Package) with cooling capacity of 40KW each LCP (e) Dual independent electrical distribution paths serving the IT equipment / racks. All critical and core IT equipment installed in Data Center are dual-powered (f) Fire rated (120 min) partitions, doors, false floor, false ceiling etc. The new IPR Data Center was inaugurated by the Director, Dr. Shashank Chaturvedi on the 28th of March 2017. The inauguration was attended by several IPR staff.

## D.2 Library Services

Institute for Plasma Research (IPR) Library caters to the specialized information needs of the user community involved in Research and Development activities in the areas of Plasma Physics and Fusion Science and Technology. Library is well equipped with modern infrastructure and continues to serve its user community with focused collection and services. Library is also involved in providing Publication Management activities and developed tools to manage internal publications. IPR library continues to subscribe to major databases such as SCOPUS, Online Archives of core journals. Library has access to SCIEDIRECT through DAE Consortium.

The library website (<http://www.ipr.res.in/library/>) is continuously updated with latest information and all subscribed resources and other large collection of in-house electronic resources such as Research and Technical Reports, Reprint, Thesis, etc. are made accessible to the user community. Library continues to provide current awareness services by delivering current content, widely to plasma physicists at national level. Total 297 News items were displayed and archived as an Alerting Service. Library started providing email alerting services for NucNet news.

During reporting period total of Rs. 24554314 budget was utilized. About 763 books and back volumes, 88 internal research reports, 49 technical reports, 34 research reports received from other research institutes, 130 reprints, 30 pamphlets and 46 software were added in to the library collection and subscribed to 109 periodicals. This year a total of 7 journal titles were migrated to only online and 4 new only online journals were added to e-collection.

Library also added 25 E-Books to its collection.

Library continued to provide Article Delivery Services through Inter Library Loan (ILL) to the user community.

89.80% of the requests made by staff members were satisfied through Inter Library Loan (ILL) service. IPR Library provided documents to other institutes against their queries and 100% of the total need were satisfied. Total 24152 photocopies supplied to users. 3252 scanned copies were provided to the users.

Library is actively carrying out Information Literacy and Training programmes for its users. Mendeley Training and Plagiarism detection software demonstration was conducted. Library orientation was given to newly joined members, Summer School Program Students, and Research Scholars. IPR Library celebrated Kalam-Chandra Week during 17-21 October 2016 to mark Birth Anniversaries of two Great Scientists, viz., Dr A P J Abdul Kalam and Nobel Laureate Subrahmanyam Chandrasekhar. A collection of their books were exhibited in library, also Posters on Kalam and Chandrasekhar were be displayed.

Library actively participated in other Institutional activities, such as Hindi Seminars/Meetings, Safety Week, National Science Day, etc. Library provided internship training programme to 04 MLISc students, two each from Central University of Gujarat (CUG), Gandhinagar, and Gujarat University, Ahmedabad during the year 2016-17.

--!!!--



## E. PUBLICATIONS AND PRESENTATIONS

### E.1 Articles Publications

#### E.1.1 Journal Articles

Thermal-Hydraulic Characteristics and Performance of 3D Straight Channel Based Printed Circuit Heat Exchanger  
A.M. ANEESH, ATUL SHARMA, ATUL SRIVASTAVA, K.N. VYAS and PARITOSH CHAUDHURI  
**Applied Thermal Engineering, 98, 474, 2016**

Growth and Structural Determination of He Bubbles in Iron/Chromium Alloys using Molecular Dynamics Simulations  
A. ABHISHEK, M. WARRIER, R. GANESH, A. CARO  
**Journal of Nuclear Materials, 472, 82, 2016**

0-D Modeling of SST-1 Plasma Break-Down & Start-Up using ECRH Assisted Pre-Ionization  
AVEG KUMAR, SUBRATA PRADHAN  
**Fusion Engineering and Design, 105, 22, 2016**

Nonlinearly Coupled Dynamics of Irregularities in the Equatorial Electrojet  
J.K. ATUL, S. SARKAR, S.K. SINGH  
**Physics Letters A, 380, 1446, 2016**

Experimental Study for Comparison of H<sub>2</sub> and Ar–H<sub>2</sub> Gas Mixture Glow Discharge Wall Conditioning in ADITYA Tokamak  
KUMARPALSINH. A. JADEJA, KAUSHAL M. PATEL, RAKESH L. TANNA, DEEPAK SANGWAN, KAUSHIK S. ACHARYA, NILESH D. PATEL, SHAILESH B. BHATT, RANJANA MANCHANDA, JOYDEEP GHOSH, and ADITYA TEAM  
**IEEE Transactions on Plasma Science, 44, 722, 2016**

GW150914: Implications for the Stochastic Gravitational-Wave Background from Binary Black Holes  
B. P. ABBOTT, G. GAUR, M. K. GUPTA, Z. KHAN, A. K. SRIVASTAVA et al. (LIGO Scientific Collaboration and Virgo Collaboration)  
**Physical Review Letters, 116, 131102, 2016**

Origin and Evolution of Spontaneous Rotation in Plasma under Different Magnetic Field Geometries in Tokamak QUEST

KISHORE MISHRA, H. ZUSHI, H. IDEI, T. ONCHI, M. HASEGAWA, and K. HANADA  
**IEEE Transactions on Plasma Science, 44, 441, 2016**

Thermal-Hydraulic Analysis of ITER Component Cooling Water System Loop 2B

BIN GUO, GIOVANNI DELL'ORCO, TEODOROS LILIANA, PLOYHAR STEVE, JUN TAO, PENG FU, LEI YANG, AJITH KUMAR, DINESH GUPTA, NIRAV PATELKUMAR, and MAHESH JADHAV  
**Journal of Fusion Energy, 35, 335, 2016**

GW150914: The Advanced LIGO Detectors in the Era of First Discoveries

B.P. ABBOTT, G. GAUR, M.K. GUPTA, Z. KHAN, A.K. SRIVASTAVA, et al (LIGO Scientific Collaboration and Virgo Collaboration)  
**Physical Review Letters, 116, 131103, 2016**

A Comparative Study of Sheath Potential Profile Measurements with Laser-Heated and Current-Heated Emissive Probes

VARA PRASAD KELLA, PAYAL MEHTA, A. SARMA, J. GHOSH and P. K. CHATTOPADHYAY  
**Review of Scientific Instruments, 87, 043508, 2016**

Observation of Quasi-Coherent Edge Fluctuations in Ohmic Plasmas on National Spherical Torus Experiment

SANTANU BANERJEE, A. DIALLO and S. J. ZWEBEN  
**Physics of Plasmas, 23, 044502, 2016**

Time Resolved Interferometric Study of the Plasma Plume Induced Shock Wave in Confined Geometry: Two-Dimensional Mapping of the Ambient and Plasma Density  
KAUSHIK CHOUDHURY, R. K. SINGH, SURYA NARAYAN, ATUL SRIVASTAVA and AJAI KUMAR  
**Physics of Plasmas, 23, 042108, 2016**

Experimental Observation of Precursor Solitons in Flowing Complex Plasma

SURABHI JAISWAL, P. BANDYOPADHYAY and A. SEN  
**Physical Review E, 93, 041201, 2016**

Analysis of Defects in Externally Driven Dust-Density Wavefronts in Cogenerated Dusty Plasma Using the Time-Resolved Hilbert–Huang Transform

SANJIB SARKAR, CHIRANJIB BARMAN, MALAY MONDAL, M BOSE and S MUKHERJEE

**Journal of Physics D: Applied Physics, 49, 205201, 2016**

Effect of Mass and Density of Ambient Gas on the Interaction of Laser-Blow-Off Plasma Plumes Propagating in Close Proximity

BHUPESH KUMAR, R. K. SINGH, and AJAI KUMAR

**Physics of Plasmas, 23, 043517, 2016**

Study on the Effect of Hydrogen Addition on the Variation of Plasma Parameters of Argon-Oxygen Magnetron Glow Discharge for Synthesis of TiO<sub>2</sub> Films

PARTHA SAIKIA, BIPUL KUMAR SAIKIA, and HEMAN BHUYAN

**AIP Advances, 6, 045206, 2016**

Computational and Experimental Investigation of Steady State and Transient Characteristics of Molten Salt Natural Circulation Loop

JAYARAJ YALLAPPA KUDARIYAWAR, ABHISHEK KUMAR SRIVASTAVA, ABHIJEET MOHAN VAIDYA, NARESH KUMAR MAHESHWARI, and POLEPALLE SATYAMURTHY

**Applied Thermal Engineering, 99, 560, 2016**

Optimum Multiscale Decomposition in NSCT-Based Single Image Super Resolution

A.J. SHAH and S.B. GUPTA

**Imaging Science Journal, 64, 3, 140, 2016**

Development of a Plasma Assisted ITER Level Controlled Heat Source and Observation of Novel Micro/Nanostructures Produced Upon Exposure of Tungsten Targets

N. AOMOA, TRINAYAN SARMAH, PUSPALATA SAH, P. CHAUDHURI, S. KHIRWARKER, J. GHOSH, B. SATPATI, M. KAKATI, G. DE TEMMERMAN

**Fusion Engineering and Design, 106, 63, 2016**

Investigation of Brazing of Ba(Zn<sub>0.33</sub>Ta<sub>0.67</sub>)O<sub>3</sub> Ceramic with Ti<sub>6</sub>Al<sub>4</sub>V Alloy

SURESH BEERA, SWATHI MANIVANNAN, AMIT KUMAR SINGH, P.K. SHARMA, G. MADHUSUDAN REDDY, DIBAKAR DAS

**Ceramics International, 42, 8072, 2016**

Tests of General Relativity with GW150914

B.P. ABBOTT, G. GAUR, M. K. GUPTA, Z. KHAN, A. K. SRIVASTAVA, et al. (LIGO Scientific and Virgo Collaborations)

**Physical Review Letters, 116, 221101, 2016**

Sub-Monolayer Growth of Ag on Flat and Nanorippled SiO<sub>2</sub> Surfaces

MUKUL BHATNAGAR, MUKESH RANJAN, KENNY JOLLEY, ROGER SMITH and SUBROTO MUKHERJEE

**Applied Physics Letters, 108, 223101, 2016**

Transport and Trapping of Dust Particles in a Potential Well Created by Inductively Coupled Diffused Plasmas

MANGILAL CHOUDHARY, S. MUKHERJEE, and P. BANDYOPADHYAY

**Review of Scientific Instruments, 87, 053505, 2016**

Comparative Study of Neutron Emission from a Plasma Focus Device Using Two Different Anode Shapes

N. TALUKDAR, S. BORTHAKUR, N. K. NEOG and T. K. BORTHAKUR

**Physics of Plasmas, 23, 052711, 2016**

Three-Dimensional Tomographic Imaging for Dynamic Radiation Behaviour Study Using Infrared Imaging Video Bolometers in Large Helical Device Plasma

RYUICHI SANO, BYRON J. PETERSON, MASARU TERANISHI, NAOFUMI IWAMA, MASAHIRO KOBAYASHI, KIYOFUMI MUKAI, and SHWETANG N. PANDYA

**Review of Scientific Instruments, 87, 053502, 2016**

Effect of Hydrogen Addition on the Deposition of Titanium Nitride Thin Films in Nitrogen Added Argon Magnetron Plasma

P SAIKIA, H BHUYAN, D E DIAZ-DROGUETT, F GUZMAN, S MANDL, B K SAIKIA, M FAVRE, J R MAZE, and E WYNDHAM

**Journal of Physics D: Applied Physics, 49, 225203, 2016**

Observation on Fundamental and Second Harmonic Mode ECRH Assisted Plasma Startup in SST-1 Experiments

KIRIT PATEL, and SUBRATA PRADHAN

**Fusion Engineering and Design, 106, 99, 2016**

Computational Fluid Dynamic Studies on Plasma Facing Heat Sink Concept for Fusion Tokamak Application

SANDEEP RIMZA, SAMIR KHIRWADKAR, KARUPANNA VELUSAMY

**Applied Thermal Engineering, 100, 1274, 2016**

Optimization of the ITER Cryodistribution for an Efficient Cooling of the Magnet System

H.-S. CHANG, R. MAEKAWA, A. FORGEAS, M. CLOUGH,



M. CHALIFOUR, H. VAGHELA, R. BHATTACHARYA,  
and B. SARKAR  
**IEEE Transactions on Applied Superconductivity, 26,**  
**4203704, 2016**

Relativistic Wave-Breaking Limit of Electrostatic Waves in  
Cold Electron-Positron-Ion Plasmas  
M. KARMAKAR, C. MAITY, N. CHAKRABARTI and S.  
SENGUPTA  
**European Physical Journal D, 70, 144, 2016**

Vapor Bubble Formation, Forces, and Induced Vibration: A  
Review  
MANOJ KUMAR GUPTA, DHARMENDRA S. SHARMA,  
and V. J. LAKHERA  
**Applied Mechanics Reviews, 63, 030801, 2016**

On the Chiral Imbalance and Weibel Instabilities  
AVDHESH KUMAR, JITESH R. BHATT, and P.K. KAW  
**Physics Letters B, 757, 317, 2016**

A Technique to Preserve Edge Information in Single Image  
Super Resolution  
AMISHA J. SHAH and SURYAKANT B. GUPTA  
**Procedia Computer Science, 85, 100, 2016**

High-Energy Neutrino Follow-Up Search of Gravitational  
Wave Event GW150914 with ANTARES and IceCube  
S. ADRIAN-MARTINEZ, G. GAUR, M. K. GUPTA, Z.  
KHAN, A. K. SRIVASTAVA, et al. (ANTARES Collaboration,  
IceCube Collaboration, LIGO Scientific Collaboration, and  
Virgo Collaboration)  
**Physical Review D, 93, 122010, 2016**

Pressurized RF Cavities in Ionizing Beams  
B. FREEMIRE, A. V. TOLLESTRUP, K. YONEHARA, M.  
CHUNG, Y. TORUN, R. P. JOHNSON, G. FLANAGAN,  
P. M. HANLET, M. G. COLLURA, M. R. JANA, M.  
LEONOVA, A. MORETTI, and T. SCHWARZ  
**Physical Review Accelerators and Beams, 19, 062004,**  
**2016**

GW151226: Observation of Gravitational Waves from a  
22-Solar-Mass Binary Black Hole Coalescence  
B. P. ABBOTT, A. DASGUPTA, G. GAUR, M. K. GUPTA,  
Z. KHAN, R. KUMAR, A. K. SRIVASTAVA, S. SUNIL, et  
al. (LIGO Scientific Collaboration and Virgo Collaboration)  
**Physical Review Letters, 116, 241103, 2016**  
Properties of the Binary Black Hole Merger GW150914

B. P. ABBOTT, G. GAUR, M. K. GUPTA, Z. KHAN, A. K.  
SRIVASTAVA, et al. (LIGO Scientific Collaboration and  
Virgo Collaboration)  
**Physical Review Letters, 116, 241102, 2016**

GW150914: First Results from the Search for Binary Black  
Hole Coalescence with Advanced LIGO  
B. P. ABBOTT, G. GAUR, M. K. GUPTA, Z. KHAN, A. K.  
SRIVASTAVA, et al. (LIGO Scientific Collaboration and  
Virgo Collaboration)  
**Physical Review D, 93, 122003, 2016**

Observing Gravitational-Wave Transient GW150914 with  
Minimal Assumptions  
B. P. ABBOTT, G. GAUR, M. K. GUPTA, Z. KHAN, A. K.  
SRIVASTAVA, et al. (LIGO Scientific Collaboration and  
Virgo Collaboration)  
**Physical Review D, 93, 122004, 2016**

Confinement Time of Electron Plasma Approaching Magnetic  
Pumping Transport Limit in Small Aspect Ratio C-Shaped  
Torus  
LAVKESH LACHHVANI, SAMBARAN PAHARI, RAJIV  
GOSWAMI, MANU BAJPAI, YOGESH YEOLE and P. K.  
CHATTOPADHYAY  
**Physics of Plasmas, 23, 062109, 2016**

Chirp-Driven Giant Phase Space Vortices  
PALLAVI TRIVEDI and RAJARAMAN GANESH  
**Physics of Plasmas, 23, 062112, 2016**

Plasma Heating Via Adiabatic Magnetic Compression-  
Expansion Cycle  
K. AVINASH, M. SENGUPTA and R. GANESH  
**Physics of Plasmas, 23, 062514, 2016**

Coulomb Fission of a Dusty Plasma  
R. L. MERLINO, J. K. MEYER, K. AVINASH and A. SEN  
**Physics of Plasmas, 23, 064506, 2016**

Design and Fabrication of a Special Purpose Winding  
Machine for ELM Control Coils of JET  
M. GHATE, S. PRADHAN, M. PATEL, D. BHAVSAR, K.  
VASAVA  
**IEEE Transactions on Applied Superconductivity, 26,**  
**0602704, 2016**

Technology Developments toward ELM Coil Manufacturing  
Appropriate for Tokamak

S. PRADHAN, M. GHATE, P. BRAHMBHATT, N. KUMAR, K. BHOPE, D. BHAVSAR, S. UDGATA, and M. PATEL  
**IEEE Transactions on Applied Superconductivity**, **26**, 4203104, 2016

Fluorescence Quenching of 8-Methyl Quinolinium: An Efficient Halide Indicator Mechanism  
RANJANA RAUTELA, PRIYANKA ARORA, NEERAJ KUMAR JOSHI, SANJAY PANT, HEM CHANDRA JOSHI  
**Journal of Molecular Liquids**, **218**, 632, 2016

Comparative Study of Approaches to Assess Damage in Thermally Fatigued Cu-Cr-Zr Alloy  
ARYA CHATTERJEE, R. MITRA, A.K. CHAKRABORTY, C. ROTTI, K. K. RAY  
**Journal of Nuclear Materials**, **474**, 120, 2016

Preliminary Design of Central Solenoid of SST-2 and Demo  
U. PRASAD, R. SRINIVASAN, S. PRADHAN, A. N. SHARMA, V. MENON, C. DANANI, D. GARG, N. RASTOGI, S. KHIRWADKER, R. KUMAR, P. K. KAW, S. DESHPANDE, A. DAS and D. BORA  
**IEEE Transactions on Applied Superconductivity**, **26**, 4200904, 2016

Search for Transient Gravitational Waves in Coincidence with Short-Duration Radio Transients during 2007-2013  
B P ABBOTT, G GAUR, M K GUPTA, Z KHAN, A K SRIVASTAVA, et al.  
**Physical Review D - Particles, Fields, Gravitation and Cosmology**, **93**, 122008, 2016

Penning Plasma Based Simultaneous Light Emission Source of Visible and VUV Lights  
G. L. VYAS, R. PRAKASH, U. N. PAL, R. MANCHANDA, and N. HALDER  
**Plasma Physics Reports**, **42**, 601, 2016

Shear Flow Driven Instability in an Incompressible Dusty Plasma with a Density Dependent Viscosity  
S. GARAI, D. BANERJEE, M. S. JANAKI, and N. CHAKRABARTI  
**Indian Journal of Physics**, **90**, 717, 2016

Scattering Chamber Facility for Double-Differential Cross-Section Measurement with 14 MeV DT Neutron Generator at IPR  
P M PRAJAPATI, BHAWNA PANDEY, N C GUPTA,

SURESH KUMAR, B K NAYAK, A SAXENA, S V SURYANARAYANA, S JAKHAR, SUDHIRSINH VALA, C V S RAO, T K BASU  
**Pramana**, **86**, 1269, 2016

Fluorescence Quenching of 8-Methyl Quinolinium: An Efficient Halide Indicator Mechanism  
RANJANA RAUTELA, PRIYANKA ARORA, NEERAJ KUMAR JOSHI, SANJAY PANT, and HEM CHANDRA JOSHI  
**Journal of Molecular Liquids**, **218**, 632, 2016

A New Approach to a Superconducting Joining Process for Carbon-Doped MgB<sub>2</sub> Conductor  
DIPAK PATEL, MD SHAHRIAR AL HOSSAIN, MINORU MAEDA, MOHAMMED SHAHABUDDIN, EKREM YANMAZ, SUBRATA PRADHAN, MIKE TOMSIC, SEYONG CHOI, and JUNG HO KIM  
**Superconductor Science and Technology**, **29**, 095001, 2016

Modification on Graphite Due to Helium Ion Irradiation  
N.J. DUTTA, S.R. MOHANTY and N. BUZARBARUAH  
**Physics Letters A**, **380**, 2525, 2016

Hydrogen Flux Measurements with Permeation Probes in Spherical Tokamak QUEST  
A. KUZMIN, H. ZUSHI, I. TAKAGI, S.K. SHARMA, Y. HIROOKA, M. KOBAYASHI, M. SAKAMOTO, K. HANADA, T. ONCHI, Y. OYAMA, N. YOUSHIDA, K. NAKAMURA, A. FUJISAWA, H. IDEI, Y. NAGASHIMA, M. HASEGAWA, and K. MISHRA  
**Vacuum**, **129**, 178, 2016

Formation of Nanostructures on HOPG Surface in Presence of Surfactant Atom during Low Energy Ion Irradiation  
M. RANJAN, P. JOSHI, and S. MUKHERJEE  
**Nuclear Instruments and Methods in Physics Research Section B: Beam Interactions with Materials and Atoms**, **379**, 57, 2016

Molecular Shear Heating and Vortex Dynamics in Thermostatted Two Dimensional Yukawa Liquids  
AKANKSHA GUPTA, RAJARAMAN GANESH, and ASHWIN JOY  
**Physics of Plasmas**, **23**, 073706, 2016

A 5 KA Pulsed Power Supply For Inductive and Plasma Loads in Large Volume Plasma Device  
P. K. SRIVASTAVA, S. K. SINGH, A. K. SANYASI, L. M.

AWASTHI, and S. K. MATTOO

**Review of Scientific Instruments** **87**, 073501, 2016

Characterization of Transient Noise in Advanced LIGO Relevant to Gravitational Wave Signal GW150914

B P ABBOTT, G GAUR, M K GUPTA, Z KHAN, A K SRIVASTAVA, et al.

**Classical and Quantum Gravity**, **33**, 134001, 2016

Numerical Simulation of 60Co-Gamma Irradiation Effects on Electrical Characteristics of N-Type FZ Silicon X-Ray Detectors

P. VIGNESHWARA RAJA, C.V.S. RAO, and N.V.L. NARASIMHA MURTY

**Nuclear Instruments and Methods in Physics Research Section B: Beam Interactions with Materials and Atoms**, **379**, 23, 2016

Monitoring Hydrogen Plasma Reduction of Oxides by Na D Lines

SARITA DAS, DEBI PRASAD DAS, PRIYANKA RAJPUT, JOYDEEP GHOSH, BHAGYADHAR BHOI, BARADA KANTA MISHRA

**Plasma Chemistry and Plasma Processing**, **36**, 4, 1125, 2016

Day Time Flight of Micrometeoroid in Upper Earth Atmosphere

SHIKHA MISRA and S. K. MISHRA

**Monthly Notices of the Royal Astronomical Society**, **459**, 2486, 2016

Formation and Evolution of Vortices in a Collisional Strongly Coupled Dusty Plasma

SAYANEE JANA, DEBABRATA BANERJEE, and NIKHIL CHAKRABARTI

**Physics Letters A**, **380**, 2531, 2016

Localization and Broadband Follow-Up of the Gravitational-Wave Transient GW150914

B. P. ABBOTT, R. ABBOTT, T.D.ABBOTT, M.R.ABERNATHY, F. ACERNESE, K. ACKLEY, C. ADAMS, T. ADAMS, P. ADDESSO, R. X. ADHIKARI

**The Astrophysical Journal Letters**, **826**, L13, 2016 Supplement

Rotational Dynamics in Ionic Liquids from NMR Relaxation Experiments and Simulations: Benzene and 1-Ethyl-3-Methylimidazolium

CHRISTOPHER A. RUMBLE, ANNE KAINZ, SHARAD K. YADAV, BRIAN CONWAY, JUAN C. ARAQUE, GARY A. BAKER, CLAUDIO MARGULIS, and MARK MARONCELLI

**Journal of Physical Chemistry B**, **120**, 9450, 2016

Measurement of Ion Species Produced Due to Bombardment of 450 eV N<sub>2</sub><sup>+</sup> Ions with Hydrocarbons-Covered Surface of Tungsten: Formation of Tungsten Nitride

S. KUMAR, P. BHATT, A. KUMAR, B.K. SINGH, B. SINGH, S. PRAJAPATI, and R. SHANKER

**Nuclear Instruments and Methods in Physics Research Section B: Beam Interactions with Materials and Atoms**, **380**, 50, 2016

Experimental Investigation of Flow Induced Dust Acoustic Shock Waves in Complex Plasma

S. JAISWAL, P. BANDYOPADHYAY and A. SEN

**Physics of Plasmas**, **23**, 083701, 2016

(IPR/RR-807/2016)

Propagation Characteristics of Dust-Acoustic Waves in Presence of a Floating Cylindrical Object in the DC Discharge Plasma

MANGILAL CHOUDHARY, S. MUKHERJEE and P. BANDYOPADHYAY

**Physics of Plasmas**, **23**, 083705, 2016

(IPR/RR-793/2016)

Observation of an Edge Coherent Mode and Poloidal Flow in the Electron Cyclotron Wave Induced High  $\beta_p$  Plasma in QUEST

SANTANU BANERJEE, H. ZUSHI, N. NISHINO, K. MISHRA, Y. MAHIRA, S. TASHIMA, A. EJIRI, T. YAMAGUCHI, T. ONCHI, Y. NAGASHIMA, K. HANADA, K. NAKAMURA, H. IDEI, M. HASEGAWA, A. FUJISAWA, A. KUZMIN and K. MATSUOKA

**Physics of Plasmas**, **23**, 082507, 2016

(IPR/RR-804/2016)

Relativistic Electron Beam Driven Longitudinal Wake-Wave Breaking in a Cold Plasma

RATAN KUMAR BERA, ARGHYA MUKHERJEE, SUDIP SENGUPTA, and AMITA DAS

**Physics of Plasmas**, **23**, 083113, 2016

Particle-in-Cell Simulation of Two-Dimensional Electron Velocity Shear Driven Instability in Relativistic Domain

CHANDRASEKHAR SHUKLA, AMITA DAS and

KARTIK PATEL

**Physics of Plasmas, 23, 082108, 2016**

Comprehensive All-Sky Search for Periodic Gravitational Waves in the Sixth Science Run LIGO Data

B. P. ABBOTT, A. DASGUPTA, G. GAUR, M. K. GUPTA, Z. KHAN, R. KUMAR, A. K. SRIVASTAVA, S. SUNIL, et al. (LIGO Scientific Collaboration and Virgo Collaboration)

**Physical Review D, 94, 042002, 2016**

A Dynamical Framework to Relate Perceptual Variability with Multisensory Information Processing

BHUMIKA THAKUR, ABHISHEK MUKHERJEE, ABHIJIT SEN and ARPAN BANERJEE

**Scientific Reports, 6, 31280, 2016**

Directly Comparing GW150914 with Numerical Solutions of Einstein's Equations for Binary Black Hole Coalescence

B. P. ABBOTT, A. DASGUPTA, G. GAUR, M. K. GUPTA, Z. KHAN, R. KUMAR, A. K. SRIVASTAVA, S. SUNIL, et al. (LIGO Scientific Collaboration and Virgo Collaboration)

**Physical Review D, 94, 064035, 2016**

Phase Mixing of Relativistically Intense Longitudinal Wave Packets in Cold Plasma

ARGHYA MUKHERJEE and SUDIP SENGUPTA

**Physics of Plasmas, 23, 92112, 2016**

Role of Neutral Gas in Scrape-Off Layer of Tokamak Plasma in the Presence of Finite Electron Temperature and its Gradient

N. BISAI and P. K. KAW

**Physics of Plasmas, 23, 92509, 2016**

**(IPR/RR-791/2016)**

BN/BNSiO<sub>2</sub> Sputtering Yield Shape Profiles under Stationary Plasma Thruster Operating Conditions

M. RANJAN, A. SHARMA, A. VAID, T. BHATT, V. NANDALAN, M. G. JAMES, H. REVATHI and S. MUKHERJEE

**AIP Advances, 6, 95224, 2016**

**(IPR/RR-824/2016)**

Study of MHD Activities in the Plasma of SST-1

JASRAJ DHONGDE, MANISHA BHANDARKAR, SUBRATA PRADHAN, and SAMEER KUMAR

**Fusion Engineering and Design, 108, 77, 2016**

Low Energy Electron Catalyst: The Electronic Origin of Catalytic Strategies

DALY DAVIS and Y. SAJEEV

**Physical Chemistry Chemical Physics, 18, 27715, 2016**

Influence of Electron-Neutral Elastic Collisions on the Instability of an Ion-Contaminated Cylindrical Electron Cloud: 2D3V PIC-With-MCC Simulations

M. SENGUPTA and R. GANESH

**Physics of Plasmas, 23, 102111, 2016**

**(IPR/RR-820/2016)**

One Dimensional PIC Simulation of Relativistic Buneman Instability

ROOPENDRA SINGH RAJAWAT and SUDIP SENGUPTA

**Physics of Plasmas, 23, 102110, 2016**

**(IPR/RR-813/2016)**

Effect of Magnetic Field Topology on Quasi-Stationary Equilibrium, Fluctuations and Flows in a Simple Toroidal Device

UMESH KUMAR, SHEKAR G THATIPAMULA, R. GANESH, Y. C. SAXENA and D. RAJU

**Physics of Plasmas, 23, 102301, 2016**

**(IPR/RR-800/2016)**

Fore-Wake Excitations from Moving Charged Objects in Complex Plasma

SANAT KUMAR TIWARI and ABHIJIT SEN

**Physics of Plasmas, 23, 100705, 2016**

**(IPR/RR-827/2016)**

Developmental Aspects of Microwave-Plasma Interaction Experiments: Phase-1

V. P. ANITHA, PRIYAVANDANA J. RATHOD, RAJ SINGH, D. V. GIRI

**IEEE Transactions on Plasma Science, 44, 7463046, 2016**

Microstructure and Wear Behaviour of Pulsed Plasma Nitrided AISI H13 Tool Steel

K. DAS, A. JOSEPH, M. GHOSH and S. MUKHERJEE

**Canadian Metallurgical Quarterly, 55, 402, 2016**

Manifestation of Anharmonic Resonance in the Interaction of Intense Ultrashort Laser Pulses with Microstructured Targets

MALAY DALUI, M. KUNDU, T. MADHU TRIVIKRAM, KRISHANU RAY and M. KRISHNAMURTHY

**Physics of Plasmas, 23, 103101, 2016**



Adhesion Characteristics on Anodized Titanium and its Durability under Aggressive Environments

S. AHMED, D. CHAKRABARTY, S. MUKHERJEE, S. BHOWMIK

**Surface Review and Letters, 23, 1650033, 2016**

Studies of Acoustic Emission Signatures for Quality Assurance of SS 316L Welded Samples under Dynamic Load Conditions

S.V. RANGANAYAKULU, M.N.V.S. RAVI KIRAN, J. SHIVA RAJU, B. RAMESH KUMAR **Journal of Engineering Science and Technology, 11, 1499, 2016**

Long-Time Evolution of Low Pressure Laboratory Plasma After Application of Transient High Voltage Positive Pulses

M. CHOUDHARY, S. KAR, S.MUKHERJEE

**Contributions to Plasma Physics, 56, 878, 2016**

Improved Analysis of GW150914 Using a Fully Spin-Precessing Waveform Model

B.P. ABBOTT, A. DASGUPTA, G. GAUR, M. K. GUPTA, Z. KHAN, R. KUMAR, A. K. SRIVASTAVA, S. SUNIL, et al. (LIGO Scientific Collaboration and Virgo Collaboration)

**Physical Review X, 6, 041014, 2016**

Binary Black Hole Mergers in the First Advanced LIGO Observing Run

B.P. ABBOTT, A. DASGUPTA, G. GAUR, M. K. GUPTA, Z. KHAN, R. KUMAR, A. K. SRIVASTAVA, S. SUNIL, et al. (LIGO Scientific Collaboration and Virgo Collaboration)

**Physical Review X, 6, 041015, 2016**

Numerical Modeling of First Experiments on PbLi MHD Flows in a Rectangular Duct with Foam-Based SiC Flow Channel Insert

S. SMOLENTSEV, C. COURTESOLE, M. ABDU, S. SHARAFAT, S. SAHU, and T. SKETCHLEY

**Fusion Engineering and Design, 108, 7, 2016**

Enhancing Detection Sensitivity of SST-1 Thomson Scattering Experiment

VISHNU CHAUDHARI, KIRAN PATEL, JINTO THOMAS, and AJAI KUMAR

**Fusion Engineering and Design, 108, 67, 2016**

Design and Characterization of A Prototype Divertor Viewing Infrared Video Bolometer for NSTX-U

G. G. VAN EDEN, M. L. REINKE, B. J. PETERSON, T. K. GRAY, L. F. DELGADO-APARICIO, M. A. JAWORSKI,

J. LORE, K. MUKAI, R. SANO, S. N. PANDYA, T. W. MORGAN

**Review of Scientific Instruments, 87, 11D402, 2016**

Effect of Driving Frequency on the Electron Energy Distribution Function and Electron-Sheath Interaction in a Low Pressure Capacitively Coupled Plasma

S. SHARMA, N. SIRSE, P. K. KAW, M. M. TURNER and A. R. ELLINGBOE

**Physics of Plasmas, 23, 110701, 2016**

Role of Temperature on Thermal Conductivity of Nanofluids: A Brief Literature Review

SAYANTAN MUKHERJEE, PURNA CH. MISHRA, S.K.S. PARASHAR, PARITOSH CHAUDHURI

**Heat and Mass Transfer, 52, 2575, 2016**

Defective Iron-Oxide Nanoparticles Synthesised by High Temperature Plasma Processing: A Magnetic Characterisation versus Temperature

C BALASUBRAMANIAN, B JOSEPH, PB ORPE, NL SAINI, S MUKHERJEE, K DZIEDZIC-KOCUREK, J STANEK, D DI GIOACCHINO and A MARCELLI

**Nanotechnology, 27, 445701, 2016**

Response of the Far Scrape-Off Layer Plasma to Strong Gas Puffing in the High Poloidal Beta Configuration of the QUEST Spherical Tokamak

T ONCHI, H ZUSHI, K MISHRA, Y OYAMA, Y NAGASHIMA, K HANADA, H IDEI, M HASEGAWA, A KUZMIN, H MIURA, K NAKAMURA, A FUJISAWA and K NAGAOKA

**Plasma Physics and Controlled Fusion, 58, 115004, 2016**

Validation and Implementation of Sandwich Structure Bottom Plate to Rib Weld Joint in the Base Section of ITER Cryostat

RAJNIKANT PRAJAPATI, ANIL K. BHARDWAJ, GIRISH GUPTA, VAIBHAV JOSHI, MITUL PATEL, JAGRUT BHAVSAR, VIPUL MORE, MUKESH JINDAL, AVIK BHATTACHARYA, GAURAV JOGI, AMIT PALALIYA, SAROJ JHA, MANISH PANDEY, PANDURANG JADHAV, HEMAL DESAI

**Fusion Engineering and Design, 109-111, Part A, 652, 2016**

Overview of Time Synchronization System of Steady State Superconducting Tokamak SST-1

A. KUMAR, H. MASAND, J. DHONGDE, K. PATEL, K. MAHAJAN, H. GULATI, M. BHANDARKAR, H.

CHUDASAMA, S. PRADHAN

**Fusion Engineering and Design, 112, 683, 2016**

Implementation of Time Synchronized Cryogenics Control System Network Architecture for SST-1

RAKESH J. PATEL, GAURANG MAHESURIA, PRADIP PANCHAL, ROHIT PANCHAL, DASARATH SONARA, VIPUL TANNA, SUBRATA PRADHAN

**Fusion Engineering and Design, 112, 747, 2016**

Preliminary Design of Safety and Interlock System for Indian Test Facility of Diagnostic Neutral Beam

HIMANSHU TYAGI, JIGNESH SONI, RATNAKAR YADAV, MAINAK BANDYOPADHYAY, CHANDRAMOULI ROTTI, AGRAJIT GAHLAUT, JAYDEEP JOSHI, DEEPAK PARMAR, GOURAB BANSAL, KAUSHAL PANDYA, ARUN CHAKRABORTY

**Fusion Engineering and Design, 112, 766, 2016**

Monitoring and Data Acquisition of the High Speed Hydrogen Pellet in SPINS

SAMIRAN SHANTI MUKHERJEE, JYOTISHANKAR MISHRA, RANJANA GANGRADEY, PRAMIT DUTTA, NAVEEN RASTOGI, PARESH PANCHAL, PRATIK NAYAK, JYOTI AGARWAL, PAWAN BAIRAGI, HARESH PATEL, HARDIK SHARMA

**Fusion Engineering and Design, 112, 757, 2016**

GPIB Based Instrumentation and Control System for ADITYA Thomson Scattering Diagnostic

KIRAN PATEL, VISHAL PILLAI, NEHA SINGH, VISHNU CHAUDHARY, JINTO THOMAS, AJAI KUMAR

**Fusion Engineering and Design, 112, 860, 2016**

Instrumentation for Status Monitoring and Protection of SST-1 Superconducting Magnets

A.N. SHARMA, U. PRASAD, K. DOSHI, P. VARMORA, Y. KHRISTI, D. PATEL, S. PRADHAN

**Fusion Engineering and Design, 112, 771, 2016**

Automation of Aditya Vacuum Control System Based on CODAC Core System

VISMAYSINH D. RAULJI, HARSHAD PUJARA, BHARAT ARAMBHADIYA, KUMARPALSINH JADEJA, SHAILESH BHATT, RACHANA RAJPAL

**Fusion Engineering and Design, 112, 910, 2016**

Design of Mass Flow Rate Measurement System for SST-1 Superconducting Magnet System

P. VARMORA, A.N. SHARMA, Y. KHRISTI, U. PRASAD,

D. PATEL, K. DOSHI, S. PRADHAN

**Fusion Engineering and Design, 112, 845, 2016**

Vessel Eddy Current Characteristics in SST-1 Tokamak

SUBRATA JANA, SUBRATA PRADHAN, JASRAJ DHONGDE, HARISH MASAND

**Fusion Engineering and Design, 112, 380, 2016**

RF Compensation of Single Langmuir Probe in Low Density Helicon Plasma

SOUMEN GHOSH, PRABAL K. CHATTOPADHYAY, JOYDEEP GHOSH, DHIRAJ BORA

**Fusion Engineering and Design, 112, 915, 2016**

Overview of Data Acquisition System for SST-1 Diagnostics

MANIKA SHARMA, IMRAN MANSURI, TUSHAR RAVAL, A.L SHARMA, S. PRADHAN

**Fusion Engineering and Design, 112, 872, 2016**

Process Automation System for Integration and Operation of Large Volume Plasma Device

R. SUGANDHI, P.K. SRIVASTAVA, A.K. SANYASI, PRABHAKAR SRIVASTAV, L.M. AWASTHI, S.K. MATTOO

**Fusion Engineering and Design, 112, 804, 2016**

Upgradation in SCADA and PLC of Existing LN2 Control System for SST-1

PRADIP PANCHAL, GAURANG MAHESURIA, ROHIT PANCHAL, RAKESH PATEL, DASHRATH SONARA, DIPEN PITRODA, HIREN NIMAVAT, VIPUL TANNA, SUBRATA PRADHAN

**Fusion Engineering and Design, 112, 883, 2016**

Design and Analysis of SST-2 Fusion Reactor

R. SRINIVASAN

**Fusion Engineering and Design, 112, 240, 2016**

Embedded Multi-Channel Data Acquisition System on FPGA for Aditya Tokamak

RACHANA RAJPAL, HITESH MANDALIYA, JIGNESH PATEL, PRAVEENA KUMARI, PRAMILA GAUTAM, VISMAYSINH RAULJI, PRAVEENLAL EDAPPALA, H.D PUJARA, R. JHA

**Fusion Engineering and Design, 112, 964, 2016**

Design, Development and Testing of Real Time Control and Data Acquisition System for R&D IC H&CD Source

KUMAR RAJNISH, DIPAL SONI, SRIPRAKASH VERMA,

HRIDAY PATEL, RAJESH TRIVEDI, RAGHURAJ SINGH, MANOJ PATEL, APARAJITA MUKHERJEE, KEYUR MAKADIA

**Fusion Engineering and Design, 112, 752, 2016**

Local Control Unit for ITER-India Gyrotron Test Facility (IIGTF)

VIPAL RATHOD, RONAK SHAH, DEEPAK MANDGE, RAJVI PARMAR, S.L. RAO

**Fusion Engineering and Design, 112, 897, 2016**

Archiving and Retrieval of Experimental Data Using SAN Based Centralized Storage System for SST-1

MANISHA BHANDARKAR, HARISH MASAND, AVEG KUMAR, KIRIT PATEL, JASRAJ DHONGDE, HITESH GULATI, KIRTI MAHAJAN, HITESH CHUDASAMA, SUBRATA PRADHAN

**Fusion Engineering and Design, 112, 991, 2016**

PXIe Based Data Acquisition and Control System for ECRH Systems on SST-1 and Aditya Tokamak

JATINKUMAR J. PATEL, B.K. SHUKLA, N. RAJANBABU, H. PATEL, P. DHORAJIYA, D. PUROHIT, K. MANKADIYA

**Fusion Engineering and Design, 112, 919, 2016**

Data Acquisition and Control System for SMARTEX – C  
YOGESH GOVIND YEOLE, LAVKESH LACHHVANI, MANU BAJPAI, SURENDRASINGH RATHOD, ABHIJEET KUMAR, K. SATHYANARAYANA, H.D. PUJARA, SAMBARAN PAHARI, PRABAL K. CHATTOPADHYAY

**Fusion Engineering and Design, 112, 818, 2016**

Development of Electronics and Data Acquisition System for Independent Calibration of Electron Cyclotron Emission Radiometer

PRAVEENA KUMARI, VISMAYSINH RAULJI, HITESH MANDALIYA, JIGNESH PATEL, VARSHA SIJU, S.K. PATHAK, RACHANA RAJPAL, R. JHA

**Fusion Engineering and Design, 112, 924, 2016**

Design and Architecture of SST-1 Basic Plasma Control System

KIRIT PATEL, D. RAJU, J. DHONGDE, K. MAHAJAN, H. CHUDASAMA, H. GULATI, A. CHAUHAN, H. MASAND, M. BHANDARKAR, S. PRADHAN

**Fusion Engineering and Design, 112, 703, 2016**

Optimization of the Diffusion Bonding Parameters for SS316L/CuCrZr with and Without Nickel Interlayer

K.P. SINGH, ALPESH PATEL, KEDAR BHOPE, S.S. KHIRWADKAR, MAYUR MEHTA **Fusion Engineering and Design, 112, 274, 2016**

Numerical Modelling for the Effective Thermal Conductivity of Lithium Meta Titanate Pebble Bed with Different Packing Structures

MAULIK PANCHAL, PARITOSH CHAUDHURI, JON T VAN LEW, ALICE YING

**Fusion Engineering and Design, 112, 303, 2016**

Development of Data Acquisition and Control System for ICH & CD Transmission Line Components Test Facility

MANOJ PATEL, AKHIL JHA, NIDHI PATEL, J.V.S. HARI KRISHNA, KUMAR RAJNISH, DIPAL SONI, SRIPRAKASH VERMA, HRIDAY PATEL, RAJESH TRIVEDI, APARAJITA MUKHERJEE

**Fusion Engineering and Design, 112, 824, 2016**

Progress in XRCS-Survey Plant Instrumentation and Control Design for ITER

SANJEEV VARSHNEY, SHIVAKANT JHA, STEFAN SIMROCK, ROBIN BARNSLEY, VINCENT MARTIN, SAPNA MISHRA, PRABHAKANT PATIL, SHREYAS PATEL, VINAY KUMAR

**Fusion Engineering and Design, 112, 877, 2016**

Status of the New WEST Plasma Control System

NATHALIE RAVENE, REMY NOUAILLETAS, JACQUELINE SIGNORET, BERNARD GUILLERMINET, WOLFGANG TREUTERRER, ANETT SPRING, HARISH MASAND, JASRAJ DHONGDE, MANISHA BHANDARKAR, CHRIS RAPSON, HEIKE LAQUA, MARC LEWERENTZ, PHILIPPE MOREAU, SYLVAIN BREMOND, LUDOVIC ALLEGRETTI, GERHARD RAUPP, ANDREAS WERNER, FRANCOIS SAINT LAURENT, ERIC NARDON

**Fusion Engineering and Design, 112, 667, 2016**

Design and First Plasma Measurements of the ITER-ECE Prototype Radiometer

M. E. AUSTIN, M. W. BROOKMAN, W. L. ROWAN, S. DANANI, E. W. BRYERTON and P. DOUGHERTY

**Review of Scientific Instruments, 87, 11E111, 2016**

Engineering Design and Analysis of Indian LLCB TBM Set  
S. RANJITHKUMAR, DEEPAK SHARMA, PARITOSH CHAUDHURI, CHANDAN DANANI, E. RAJENDRA KUMAR, ISTIYAK KHAN, SUJAY BHATTACHARYA,

K.N. VYAS

**Fusion Engineering and Design, 109-111, Part B, 1581, 2016**

Overview and Status of ITER Cryostat Manufacturing

ANIL K. BHARDWAJ, GIRISH GUPTA, RAJNIKANT PRAJAPATI, VAIBHAV JOSHI, MITUL PATEL, JAGRUT BHAVSAR, VIPUL MORE, MUKESH JINDAL, AVIK BHATTACHARYA, GOURAV JOGI, AMIT PALALIYA, SAROJ JHA, MANISH PANDEY, DILEEP SHUKLA, GANESH IYER, PANDURANG JADHAV, DIPESH GOYAL, ANISH DESAI, I. SEKACHEV, GUILLAUME VITUPIER, XIE HAN, TAILHARDAT OLIVIER

**Fusion Engineering and Design, 109-111, Part B, 1351, 2016**

Structural Analysis of ITER Multi-Purpose Deployer

MANOAH STEPHEN MANUELRAJ, PRAMIT DUTTA, KRISHAN KUMAR GOTEWAL, NAVEEN RASTOGI, ALESSANDRO TESINI, CHANG-HWAN CHOI

**Fusion Engineering and Design, 109-111, Part B, 1296, 2016**

Thermal-Hydraulics of LLCB TBM under Different ITER Operational Conditions

PARITOSH CHAUDHURI, S. RANJITHKUMAR, DEEPAK SHARMA, CHANDAN DANANI, E. RAJENDRA KUMAR

**Fusion Engineering and Design, 109-111, Part A, 906, 2016**

Molecular Dynamics Studies of Sticking and Reflection of Low-Energy Deuterium on Single Crystal Tungsten  
P.N. MAYA

**Journal of Nuclear Materials, 480, 411, 2016**

Flowing Dusty Plasma Experiments: Generation of Flow and Measurement Techniques

S JAISWAL, P BANDYOPADHYAY and A SEN

**Plasma Sources Science and Technology, 25, 065021, 2016 (IPR/RR-815/2016)**

Study of Fatigue Crack Growth in RAFM Steel using Acoustic Emission Technique

M. NANI BABU, C.K. MUKHOPADHYAY, G. SASIKALA, SHAJU K. ALBERT, A.K. BHADURI, T. JAYAKUMAR, and RAJENDRA KUMAR

**Journal of Constructional Steel Research, 126, 107, 2016**

Overview of LLCB TBM Design and R&D Activities in India

E. RAJENDRA KUMAR, K.N. VYAS, T. JAYAKUMAR

**Fusion Engineering and Design, 109-111, Part B, 1522, 2016**

Accident Analyses of Selected Postulated Events for Safety Assessment of Indian LLCB TBS in ITER

K.T. SANDEEP, VILAS CHAUDHARI

**Fusion Engineering and Design, 109-111, Part B, 1534, 2016**

Radwaste Management Aspects of the Test Blanket Systems in ITER

J.G. VAN DER LAAN, D. CANAS, V. CHAUDHARI, M. ISELI, Y. KAWAMURA, D.W. LEE, P. PETIT, C.S. PITCHER, D. TORCY, D. UGOLINI, H. ZHANG

**Fusion Engineering and Design, 109-111, Part A, 222, 2016**

Machine Control System of Steady State Superconducting Tokamak-1

HARISH MASAND, AVEG KUMAR, M. BHANDARKAR, K. MAHAJAN, H. GULATI, J. DHONGDE, K. PATEL, H. CHUDASMA, S. PRADHAN

**Fusion Engineering and Design, 112, 731, 2016**

Development of a Control System for Compression and Expansion Cycles of Critical Valve for High Vacuum Systems  
JYOTI AGARWAL, H. SHARMA, HARESH PATEL, R. GANGRADEY, VRUSHABH LAMBADE

**Fusion Engineering and Design, 112, 735, 2016**

Multi-Channel Control Circuit for Real-Time Control of Events in Aditya Tokamak

PRAVEENLAL EDAPPALA, MINSHA SHAH, RACHANA RAJPAL, R.L. TANNA, JOYDEEP GHOSH, P.K. CHATTOPADHYAY, R. JHA

**Fusion Engineering and Design, 112, 678, 2016**

Overview of Data Acquisition and Central Control System of Steady State Superconducting Tokamak (SST-1)

S. PRADHAN, K. MAHAJAN, H.K. GULATI, M. SHARMA, A. KUMAR, K. PATEL, H. MASAND, I. MANSURI, J. DHONGDE, M. BHANDARKAR, H. CHUDASAMA

**Fusion Engineering and Design, 112, 718, 2016**

Operation and Control of High Power Gyrotrons for ECRH Systems in SST-1 and Aditya

B.K. SHUKLA, D. BORA, R. JHA, JATIN PATEL, HARSHIDA PATEL, RAJAN BABU, PRAGNESH



DHORAJIYA, SHEFALI DALAKOTI, DHARMESH PUROHIT

**Fusion Engineering and Design, 112, 673, 2016**

Universal Interface on Zynq® Soc with CAN, RS-232, Ethernet and AXI GPIO for Instrumentation & Control  
ABHIJEET KUMAR, RACHANA RAJPAL, HARSHAD PUJARA, HITESH MANDALIYA, PRAVEENALAL EDAPPALA

**Fusion Engineering and Design, 112, 865, 2016**

Use of EPICS and Python Technology for the Development of a Computational Toolkit for High Heat Flux Testing of Plasma Facing Components

RITESH SUGANDHI, RAJAMANNAR SWAMY, SAMIR KHIRWADKAR

**Fusion Engineering and Design, 112, 783, 2016**

Automation of Aditya Tokamak Plasma Position Control DC Power Supply

BHARAT ARAMBHADIYA, HARSHITA RAJ, R.L. TANNA, PRAVEENLAL EDAPPALA, RACHANA RAJPAL, JOYDEEP GHOSH, P.K. CHATTOPADHYAY, M.B. KALAL

**Fusion Engineering and Design, 112, 714, 2016**

FPGA Based Phase Detection Technique for Electron Density Measurement in SST-1 Tokamak

PRAMILA, HITESH MANDALIYA, RACHANA RAJPAL, RAJWINDER KAUR

**Fusion Engineering and Design, 112, 888, 2016**

First Targeted Search for Gravitational-Wave Bursts from Core-Collapse Supernovae in Data of First-Generation Laser Interferometer Detectors

B.P. ABBOTT, G. GAUR, M. K. GUPTA, Z. KHAN, A. K. SRIVASTAVA, et al. (LIGO Scientific Collaboration and Virgo Collaboration)

**Physical Review D, 94, 102001, 2016**

Results of the Deepest All-Sky Survey for Continuous Gravitational Waves on LIGO S6 Data Running on the Einstein@Home Volunteer Distributed Computing Project

B.P. ABBOTT, A. DASGUPTA, G. GAUR, M. K. GUPTA, Z. KHAN, R. KUMAR, A. K. SRIVASTAVA, S. SUNIL, et al. (LIGO Scientific Collaboration and Virgo Collaboration)

**Physical Review D, 94, 102002, 2016**

Fabrication, Transport Current Testing, and Finite Element

Analysis of MgB<sub>2</sub> Racetrack Coils

ANANYA KUNDU, DIPAK PATEL, NITISH KUMAR, ARUN G. PANCHAL, WENBIN QIU, HYUNSEOCK JIEZONGQING, MAEKREM YANMAZ, MOHAMMED SHAHABUDDIN, JUNG HO KIM, SUBRATA PRADHAN, MD SHAHRIAR AL HOSSAIN

**Journal of Superconductivity and Novel Magnetism, 1-6, 2016**

A Novel Technique toward Fabricating High-Current-Carrying MgB<sub>2</sub>-Based Superconducting Joints

SUBRATA PRADHAN, SUBRAT KUMAR DAS, ANEES BANO, ANANYA KUNDU

**IEEE Transactions on Applied Superconductivity, 26, 7523213, 2016**

Prototype High Voltage Bushing: Configuration to its Operational Demonstration

SEJAL SHAH, D. SHARMA, D. PARMAR, H. TYAGI, K. JOSHI, H. SHISHANGIYA, M. BANDYOPADHYAY, C. ROTTI, A. CHAKRABORTY

**Fusion Engineering and Design, 113, 6, 2016**

Neutronic Performance of Indian LLCB TBM Set Conceptual Design in ITER

H.L. SWAMI, A.K. SHAW, A.N. MISTRY, C. DANANI

**Fusion Engineering and Design, 113, 71, 2016**

Electrical Testing and Performance Evaluation of 1:1 Prototype JET ELM Control Coils

DEVEN KANABAR, SWATI ROY, MAHESH GHATE, PIYUSH RAJ, ANANYA KUNDU, NITISH KUMAR, DHAVAL BHAVSAR, ARUN PANCHAL, SUBRATA PRADHAN

**Fusion Engineering and Design, 113, 171, 2016**

The Stability of 1-D Soliton in Transverse Direction

DEEPA VERMA, RATAN KUMAR BERA, AMITA DAS, and PREDHIMAN KAW

**Physics of Plasmas, 23, 123102, 2016**

Long Duration Operational Characteristics of the First Indian 42-GHz, 200-Kw Gyrotron

PIYUSH RAJ, UPENDRA PRASAD, YOHAN KHRISTI, MAHESH GHATE, ARUN PANCHAL, DHAVAL BHAVSAR, MONI BANAUDHA, DEVEN KANABAR, BHADRESH R. PARGHI and SUBRATA PRADHAN

**IEEE Transactions on Applied Superconductivity, 26, 7723878, 2016**

- A Technique to Control Cross-Field Diffusion of Plasma across a Transverse Magnetic Field  
P. HAZARIKA, M. CHAKRABORTY, B. K. DAS and M. BANDYOPADHYAY  
**Physics of Plasmas, 23, 122105, 2016**
- Sol-Gel Followed By Urea-Acetone Spherodization for Preparation of Lithium Titanate Ceramics Pebbles and Preliminary Characterization  
S.K. SINHAA, S. YADAVA, P.M. RAOLE  
**Fusion Engineering and Design, 113, 146, 2016**
- Complex Plasma Experimental Device - A Test Bed for Studying Dust Vortices and Other Collective Phenomena  
MANJIT KAUR, SAYAK BOSE, P K CHATTOPADHYAY, J GHOSH, Y C SAXENA  
**Pramana - Journal of Physics, 87, 89, 2016**
- Upper Limits On the Rates of Binary Neutron Star and Neutron Star-Black Hole Mergers from Advanced LIGO's First Observing Run  
B. P. ABBOTT, A. DASGUPTA, G. GAUR, M. K. GUPTA, Z. KHAN, R. KUMAR, A. K. SRIVASTAVA, S. SUNIL et. al.  
**Astrophysical Journal Letters, 832, L21, 2016**
- Experimental Observation of Phase-Flip Transitions in Two Inductively Coupled Glow Discharge Plasmas  
NEERAJ CHAUBEY, S. MUKHERJEE, A. SEN, and A. N. SEKAR IYENGAR  
**Physical Review E - Statistical, Nonlinear, and Soft Matter Physics, 94, 061201, 2016**
- Er<sub>2</sub>O<sub>3</sub> Coating by Reactive Magnetron Sputtering: Effect of Oxygen Supply and Erbium Pre-Layer Deposition  
P.A. RAYJADA, N.P. VAGHELA, R. RAHMAN, M. BHATNAGAR, M. RANJAN, N.L. CHAUHAN, AMIT SIRCAR, L.M. MANOCHA, P.M. RAOLE  
**Nuclear Materials and Energy, 9, 256, 2016**
- Analysis of Impurities on Contaminated Surface of the Tokamak Limiter Using Laser Induced Breakdown Spectroscopy  
GULAB SINGH MAURYA, ROHIT KUMAR, AJAI KUMAR, AWADHESH K. RAI  
**SpectrochimicaActa Part B: Atomic Spectroscopy, 126, 17, 2016**
- Behavior of Plasma Sheath with Nonextensively Distributed Two-Temperature Electrons and Isothermal Ions  
DIMA RANI BORGOHAIN, K. SAHARIA, K. S. GOSWAMI  
**Physics of Plasmas, 23, 122113, 2016**
- Molecular Dynamics Study of Flow past an Obstacle in Strongly Coupled Yukawa Liquids  
HARISH CHARAN, RAJARAMAN GANESH  
**Physics of Plasmas, 23, 123703, 2016**
- Observation of Mode Transition and Low-Frequency Oscillations in Magnetically Constricted Anode  
S. CHAUHAN, M. RANJAN, M. BANDYOPADHYAY, S. MUKHERJEE  
**Physics of Plasmas, 23, 123524, 2016**
- Anharmonic Resonance Absorption of Short Laser Pulses in Clusters: A Molecular Dynamics Simulation Study  
S. S. MAHALIK, M. KUNDU  
**Physics of Plasmas, 23, 123302, 2016 (IPR/RR-830/2016)**
- Propagation Characteristics of an Extremely Anisotropic Metamaterial Loaded Helical Guide  
DUSHYANT K. SHARMA and SURYA K. PATHAK  
**Optics Express, 24, 29521, 2016**
- Constraining Scalar-Gauss-Bonnet Inflation by Reheating, Unitarity, and Planck Data  
SRIJIT BHATTACHARJEE, DEBAPRASAD MAITY, and RUPAK MUKHERJEE  
**Physical Review D, 95, 023514, 2017**
- System Upgradation for Surface Mode Negative Ion Beam Extraction Experiments in ROBIN  
KAUSHAL PANDYA, GOURAB BANSAL, AGRAJIT GAHLAUT, JIGNESH SONI, RATNAKAR K. YADAV, VUPPUGALLA MAHESH, HIMANSHU TYAGI, KANUG. PARMAR, HIREN MISTRI, JIGHESH BHAGORA, BHAVESH PRAJAPATI, KARTIK PATEL, MANAS BHUYAN, MEHUL GOUSWAMI, MAINAK BANDYOPADHYAY, ARUN K. CHAKRABORTY  
**Fusion Engineering and Design, 114, 187, 2017**
- Nanotribological Response of a Plasma Nitrided Bio-Steel  
ANIRUDDHA SAMANTA, HIMEL CHAKRABORTY, MANJIMA BHATTACHARYA, JITEN GHOSH, MONJOY SREEMANY, SANDIP BYSAKH, RAMKRISHNA RANE, ALPHONSA JOSEPH, GHANSHYAM JHALA,



SUBROTO MUKHERJEE, MITUN DAS, ANOOP K. MUKHOPADHYAY

**Journal of the Mechanical Behavior of Biomedical Materials, 65, 584, 2017**

An Automated Approach for Real Time Diagnostics of Electrical and Optical Parameters for ESD Events at Triple Junction

R.S. JOSHI, S.B. GUPTA

**Measurement, 95, 465, 2017**

MHD Mode Evolutions Prior to Minor and Major Disruptions in SST-1 Plasma

JASRAJ DHONGDE, SUBRATA PRADHAN, MANISHA BHANDARKAR

**Fusion Engineering and Design, 114, 6, 2017**

Analysis of Trapped Oscillation Modes in Magnetized PPC and its Tunability for Variable Plasma Parameters

TANVI MITTAL, RANAPRATAP YADAV, and DHIRAJ BORA

**Optics Communications, 382, 7, 2017**

Transient Thermo-Structural and Static Magnetic Characteristics of 1:1 Prototype JET ELM Control Coils

ANANYA KUNDU, SUBRATA PRADHAN, MAHESH GHATE, DEVEN KANABAR, SWATI ROY, NITISH KUMAR

**Fusion Engineering and Design, 114, 203, 2017**

Collective Dynamics of Time-Delay-Coupled Phase Oscillators in a Frustrated Geometry

BHUMIKA THAKUR, DEVENDRA SHARMA, ABHIJIT SEN, and GEORGE L. JOHNSTON

**Physical Review E, 95, 012204, 2017**

Achieving Ultrahigh Vacuum in an Unbaked Chamber with Glow Discharge Conditioning

ZIAUDDIN KHAN, PRATIBHA SEMWAL, KALPESH R DHANANI, DILIP C RAVAL, SUBRATA PRADHAN

**Pramana - Journal of Physics, 88, 12, 2017**

An Enhanced Tokamak Startup Model

RAJIV GOSWAMI, JEAN-FRANCOIS ARTAUD

**Physics of Plasmas, 24, 012508, 2017**

Characteristics of Floating Potential of a Probe in Electronegative Plasma

A. K. PANDEY and S. K. KARKARI

**Physics of Plasmas, 24, 013507, 2017 (IPR/RR-833/2016)**

The Effect of Intermediate Frequency on Sheath Dynamics in Collisionless Current Driven

Triple Frequency Capacitive Plasmas

S. SHARMA, S. K. MISHRA, P. K. KAW, and M. M. TURNER

**Physics of Plasmas, 24, 013509, 2017**

Mass Selection in Laser-Plasma Ion Accelerator on Nanostructured Surfaces

MALAY DALUI, M. KUNDU, SUBHRANGSU SARKAR, SHEROY TATA, JOHN PASLEY, P. AYYUB, and D M. KRISHNAMURTHY

**Physics of Plasmas, 24, 010703, 2017**

The Basic Physics of the Binary Black Hole Merger GW150914

B.P. ABBOTT, A. DASGUPTA, G. GAUR, M. K. GUPTA, Z. KHAN, R. KUMAR, A. K. SRIVASTAVA, S. SUNIL, et al. (LIGO Scientific Collaboration and Virgo Collaboration)

**Annalen Der Physik, 529, 1600209, 2017**

Exploring the Sensitivity of Next Generation Gravitational Wave Detectors

B. P. ABBOTT, A. DASGUPTA, G. GAUR, M. K. GUPTA, Z. KHAN, R. KUMAR, A. K. SRIVASTAVA, S. SUNIL, et al. (LIGO Scientific Collaboration)

**Classical and Quantum Gravity, 34, 044001, 2017**

Friction and Wear Performance of Bearing Ball Sliding against Diamond-Like Carbon Coatings

SHENJIANG WU, HIROYUKI KOUSAKA, SATYANANDA KAR, DANGJUAN LI, and JUNHONG SU

**Materials Research Express, 4, 015602, 2017**

In-Plane and Out-Of-Plane Plasmons in Random Silver Nanoisland Films

MAHIMA ARYA, MUKESH RANJAN, MUKUL BHATNAGAR, RABINDRA NATH, ANIRBAN MITRA

**Plasmonics, 1-11, 2017**

Novel Lightning Strike-Protected Polymeric Composite for Future Generation Aviation

SURESH SHARMA, A. NIVETHA, A. MAALAVAN, K. SIVA SUBRAMANIAN, S. SREE KUMAR, MOHAN KUMAR PITCHAN, S. BHOWMIK, S. RAMANATHAN; R. RANE, and S. MUKHERJEE

**Journal of Aerospace Engineering, 30, 04016073, 2017**

Edge Transport and Fluctuation Induced Turbulence Characteristics in Early SST-1 Plasma

B. KAKATI, S. PRADHAN, J. DHONGDE, P. SEMWAL, K. YOHAN, M. BANAUDHA

**Fusion Engineering and Design, 115, 85, 2017**

Thermal Dynamics of Silver Clusters Grown on Rippled Silica Surfaces

MUKUL BHATNAGAR, MUKESH RANJAN, KENNY JOLLEY, ADAM LLOYD, ROGER SMITH, SUBROTO MUKHERJEE

**Nuclear Instruments and Methods in Physics Research B, 393, 5, 2017**

Open Loop Control of Filament Heating Power Supply for Large Volume Plasma Device

R. SUGANDHI, P.K. SRIVASTAVA, A.K. SANYASI, PRABHAKAR SRIVASTAV, L.M. AWASTHI, S.K. MATTOO

**Fusion Engineering and Design, 115, 49, 2017**

Formation of Annular Plasma Downstream By Magnetic Aperture in the Helicon Experimental Device

SOU MEN GHOSH, S. YADAV, K. K. BARADA, P. K. CHATTOPADHYAY, J. GHOSH, R. PAL, and D. BORA

**Physics of Plasmas, 24, 020703, 2017**

Transition from Single to Multiple Axial Potential Structures in Expanding Helicon Plasma

SOU MEN GHOSH, PRABAL K CHATTOPADHYAY, JOYDEEP GHOSH, D BORA

**Journal of Physics D Applied Physics, 50, 065201, 2017**

All-Sky Search for Short Gravitational-Wave Bursts In the First Advanced LIGO Run

B.P. ABBOTT, A. DASGUPTA, G. GAUR, M. K. GUPTA, Z. KHAN, R. KUMAR, A. K. SRIVASTAVA, S. SUNIL, et al. (LIGO Scientific Collaboration and Virgo Collaboration)

**Physical Review D, 95, 042003, 2017**

Behavior of Non-Thermal Electrons during ECR Pre-Ionization at Aditya Tokamak

SHISHIR PUROHIT, SHANKARA JOISA, MALAY BIKAS CHOWDHURI, BRAJKISHORE SHUKLA, JAYESH RAVAL, RANJANA MANCHANDA, NILAM RAMAIYA, UMESH NAGORA, PARVEEN ATREY, RAKESH TANNA, KUMARPALSINH JADEJA, SHAILESH BHATT, CHETNARAYAN GUPTA, AJAI KUMAR, JOYDEEP GHOSH and ADITYA TEAM

**Plasma and Fusion Research, 12, 2402002, 2017**

Communication: Low-Energy Free-Electron Driven Molecular Engineering: In Situ Preparation of Intrinsically Short-Lived Carbon-Carbon Covalent Dimer of CO

DALY DAVIS and Y. SAJEEV

**Journal of Chemical Physics, 146, 081101, 2017**

Geodesic Acoustic Modes with Poloidal Mode Couplings Ad Infinitum

RAMESWAR SINGH and O. D. GURCAN

**Physics of Plasmas, 24, 022507, 2017**

Control of Intrinsic Defects in Lithium Niobate Single Crystal for Optoelectronic Applications

RAJEEV BHATT, INDRANIL BHAUMIK, SARVESWARAN GANESAMOORTHY, RISCOB BRIGHT, MOHAMMAD SOHARAB, ASHWANI KUMAR KARNAL, and PRADEEP KUMAR GUPTA

**Crystals, 7, 23, 2017**

Plasma Potential Measurement Using Centre Tapped Emissive Probe (CTEP) in Laboratory Plasma

A.K. SANYASI, P.K. SRIVASTAVA and L.M. AWASTHI

**Measurement Science and Technology, 28, 2017**

Activation and Radioactive Waste Analysis for Survey X-Ray Crystal Spectrometer of ITER

P. V. SUBHASH, GUNJAN INDAULIYA, SAI CHAITANYA TADEPALLI, PRITI KANTH, SHRICHAND JAKHAR, SANJEEV VARSHNEY, SIDDHARTH KUMAR, RAJA KRISHNA, NIRAV BHALIYA, SAPNA MISHRA, P. SHRISHAIL, VINAY KUMAR

**Fusion Science and Technology, 71, 215, 2017**

Interaction and Propagation Characteristics of Two Counter and Co-Propagating Mach Cones in a Dusty Plasma

P. BANDYOPADHYAY, R. DEY, and A. SEN

**Physics of Plasmas, 24, 033706, 2017**

Experimental Observation of Self Excited Co-Rotating Multiple Vortices in a Dusty Plasma with Inhomogeneous Plasma Background

MANGILAL CHOUDHARY, S. MUKHERJEE, and P. BANDYOPADHYAY

**Physics of Plasmas, 24, 033703, 2017**

Raman Spectroscopy of Laser Shocked Polystyrene

VINAY RASTOGI, S. CHAURASIA, USHA RAO, C. D. SIJOY, V. MISHRA, MANMOHAN KUMAR, M. N. DEO, S. CHATURVEDI, SURINDER M. SHARMA

**Journal of Raman Spectroscopy, 48, 458, 2017**



Multi-Scale Computational Approach for Modelling Spallation at High Strain Rates in Single-Crystal Materials  
V.R.IKKURTHI, H. HEMANI, R. SUGANDHI, S. RAWAT, P. PAHARI, M. WARRIER, S. CHATURVEDI  
**Procedia Engineering, 173, 1177, 2017**

Nonlinear Effects in the Bounded Dust-Vortex Flow in Plasma  
MODHUCHANDRA LAISHRAM, DEVENDRA SHARMA, PRABAL K. CHATTOPADHYAY, and PREDHIMAN K. KAW  
**Physical Review E, 95, 033204, 2017**

Doping-Induced Isotopic Mg11B2 Bulk Superconductor for Fusion Application  
QI CAI, QIANYING GUO, YONGCHANG LIU, ZONGQING MA, HUIJUN LI, WENBIN QIU, DIPAK PATEL, HYUNSEOCK JIE, JUNG HO KIM, MEHMET SOMER, EKREM YANMAZ, ARNAUD DEVRED, VLADIMIR LUZIN, AMANULLAH FATEHMULLA, WAZIRZADA ASLAM FAROOQ, DANIEL GAJDA, YOSHIO BANDO, YUSUKE YAMAUCHI, SUBRATA PRADHAN and MD. SHAHRIAR A. HOSSAIN  
**Energies, 10, 409, 2017**

Directional Limits on Persistent Gravitational Waves from Advanced LIGO's First Observing Run  
B.P. ABBOTT, A. DASGUPTA, M. K. GUPTA, Z. KHAN, R. KUMAR, A. K. SRIVASTAVA, S. SUNIL, et al. (LIGO Scientific Collaboration and Virgo Collaboration)  
**Physical Review Letters, 118, 121102, 2017**

Calibration of the Advanced LIGO Detectors for the Discovery of the Binary Black-Hole Merger GW150914  
B.P. ABBOTT, G. GAUR, M. K. GUPTA, Z. KHAN, A. K. SRIVASTAVA et al. (LIGO Scientific Collaboration)  
**Physical Review D, 95, 062003, 2017**

Upper Limits on the Stochastic Gravitational-Wave Background from Advanced LIGO's First Observing Run  
B.P. ABBOTT, A. DASGUPTA, M. K. GUPTA, Z. KHAN, R. KUMAR, A. K. SRIVASTAVA, S. SUNIL, et al. (LIGO Scientific Collaboration and Virgo Collaboration)  
**Physical Review Letters, 118, 121101, 2017**

Observation of Ion-Ion Counter Streaming Instability in Presheath-Sheath Region of a Mesh Grid Immersed in Low Temperature Plasma  
VARA PRASAD KELLA, J. GHOSH, P. K.

CHATTOPADHYAY, D. SHARMA, and Y. C. SAXENA  
**Physics of Plasmas, 24, 032110, 2017**

Two Directional Fast Imaging of Plasma Plume in Variable Magnetic Field: Structure and Dynamics of the Plume in Diamagnetic and Non-Diamagnetic Limits  
NARAYAN BEHERA, R. K. SINGH, V. CHAUDHARI, and AJAI KUMAR  
**Physics of Plasmas, 24, 033511, 2017**

Destabilization of a Cylindrically Confined Electron Cloud by Impact Ionization of Background Neutrals: 2D3v PIC Simulation with Monte-Carlo-Collisions  
M. SENGUPTA, R. GANESH  
**Physics of Plasmas, 24, 032105, 2017**

Driven Phase Space Vortices in Plasmas with Nonextensive Velocity Distribution  
PALLAVI TRIVEDI, RAJARAMAN GANESH  
**Physics of Plasmas, 24, 032107, 2017**

On The Nonlinear Trapping Nature of Undamped, Coherent Structures in Collisionless Plasmas and Its Impact on Stability  
HANS SCHAMEL, DEBRAJ MANDAL, and DEVENDRA SHARMA  
**Physics of Plasmas, 24, 032109, 2017**

Study of Dynamical Behaviour of the Plasma in a Dc Non-Transferred Plasma Torch using Fast Imaging  
VIDHI GOYAL, G. RAVI, P. BANDYOPADHYAY, S. BANERJEE, V. YUGESH, and S. MUKHERJEE  
**Physics of Plasmas, 24, 033506, 2017**

### E.1.2 Conference Papers

Kinetic Simulation of Electron Transport Using Electron Magneto-hydrodynamic Structures  
MASAYASU HATA, HITOSHI SAKAGAMI, and AMITA DAS  
**Journal of Physics: Conference Series, 688, 012027, 2016**

Anomalous Inverse Bremsstrahlung Heating of Laser-Driven Plasmas  
MRITYUNJAY KUNDU  
**Journal of Physics: Conference Series, 717, 012068, 2016**

Thermal Contact Resistance Measurement of Conduction Cooled Binary Current Lead Joint Block in Cryocooler Based Self Field I-V Characterization Facility

ANANYA KUNDU, SUBRAT KUMAR DAS, ANEES BANO POOJA AGARWAL and SUBRATA PRADHAN  
*AIP Conference Proceedings, 1731, 080082, 2016*

Elastic, Inelastic and Inclusive Alpha Cross Sections in  $6\text{Li}+^{112}\text{Sn}$  System

D. CHATTOPADHYAY, S. SANTRA, A. PAL, A. KUNDU, B. K. NAYAK, K. MAHATA, K. RAMACHANDRAN, R. TRIPATHI, V. V. PARKAR, S. SODAYE, D. SARKAR, B. PANDEY and G. KAUR

*EPJ Web of Conferences, 117, 06022, 2016*

Mechanical Arrangement for Assembly of IWS Blocks to ITER Vacuum Vessel

GURLOVLEEN SINGH., H. A. PATHAK, JIGAR RAVAL  
*Proceedings - Symposium on Fusion Engineering, 2016, 7482284, 2016*

Concurrent Construction on Evolving Design: ITER-India Experience and Lessons for Future S.P. DESHPANDE, I. BANDYOPADHYAY, U.K. BARUAH, A.K. BHARDWAJ, A.K. CHAKRABORTY, A. KUMAR, V. KUMAR, A. MUKHERJEE, S.B. PADASALAGI, H.A. PATHAK, S.L. RAO, B. SARKAR, RANJAY SHARAN

*Proceedings - Symposium on Fusion Engineering, 2016, 7482281, 2016*

Visual Inspection and Motion Control for In-vessel Tile Servoing Tasks in a Tokamak Vessel

BALAKRISHNAN, V., SENAPATHI, M., SRINIVAS, J.  
*Proceedings - Symposium on Fusion Engineering, 2016, 7482325, 2016*

Effects of Mechanical Loads on ITER XRCS-Survey Sight-Tube

SIDDHARTH KUMAR, SANJEEV VARSHNEY, KUNAL BHATT, NIRAV BHALIYA, SHRISHAIL PADASALAGI, SAPNA MISHRA, P.V. SUBHASH, VINAY KUMAR, ROBIN BARNESLEY, PHILIPPE BERNASCOLLE, JEAN-MARC DREVON

*Proceedings - Symposium on Fusion Engineering, 2016, 7482309, 2016*

Physics and Engineering Issues Associated With Increasing Beam Energy on the DIII-D Neutral Beam System

B. CROWLEY, J. RAUCH, J.T. SCOVILLE, S.K. SHARMA, B. CHOKSI

*Proceedings - Symposium on Fusion Engineering, 2016, 7482269, 2016*

Lessons Learned During the Procurement of the ITER Steady State Electrical Network Components by the US Domestic Agency

C. NEUMEYER, J. DELLAS, J. HOURTOULE, A. DAS, S. NAIR

*Proceedings - Symposium on Fusion Engineering, 2016, 7482282, 2016*

Manufacturing Experience of Beam Dump for SPIDER Facility

H. PATEL, C. ROTTI, M.V. NAGARAJU, A. CHAKRABORTY, B. SCHUNKE, J. CHAREYRE, D. BOILSON, L. SVENSSON, M.DALLA PALMA, P. ZACCARIA, R. PASQUALOTTO, E. PFAFF, J. SCHAFFER, C. ECKARDT

*Proceedings - Symposium on Fusion Engineering, 2016, 7482368, 2016*

Integration of Diagnostics on ITER

M. WALSH, V. KUMAR, et al

*Proceedings - Symposium on Fusion Engineering, 2016, 7482260, 2016*

Recent High Current Plasma Discharges Operations with Booster Power Supply Assisted Vertical Magnetic Field in Aditya Tokamak

C.N.GUPTA, KUNAL SHAH, M. N.MAKWANA, R. L. TANNA, P.K.CHATTOPADHYAY, V.K.PATEL, V.K.PANCHAL, CHHAYA CHAVDA, S.B.BHATT, J. GHOSH

*IEEE 26th Symposium on Fusion Engineering (SOFE), 16038990, 2016*

ECRH Assisted Plasma Experiments on Tokamaks SST-1 and Aditya

B. K.SHUKLA, D.BORA, R.JHA, S.PRADHAN, JOYDEEP GHOSH, C.N.GUPTA, J.PATEL, RAJAN BABU, HARSHIDA PATEL, PRAGNESH DHORAJIA, R.TANNA, V.TANNA, P.K. ATREY, S. JOISA, S. B. BHATT, DHARMESH PUROHIT, P. K. CHATTOPADHYAYA, D. RAJU, PARESH PATEL, R. MANCHANDA, MANOJ GUPTA

*IEEE 26th Symposium on Fusion Engineering (SOFE), 16039052, 2016*

Design & Development of Electrical System for TWIN Source

DEEPAK PARMAR, H. SHISHANGIYA, M.N. VISHNUDEV, M. BANDYOPADHYAY, R. YADAV,



J. BHAGORA, S. SHAH, DASS SUDHIR, H. TYAGI, A. CHAKRABORTY, V. MAHESH, A. GAHLAUT, G. PARMAR, B. PRAJAPATI, J. SONI, R. PANDEY, G. BANSAL, K. PANDYA

*IEEE 26th Symposium on Fusion Engineering (SOFE), 16039001, 2016*

Indian Test Facility (INTF) - A Status Update

A. CHAKRABORTY, UBARUAH, M. BANDYOPADHYAY, J. BHAGORA, M. BHUYAN, DASS SUDHIR, J. JOSHI, K. JOSHI, M. V. NAGARAJU, D. PARMAR, H. PATEL, M. PATEL, S. PILLAI, G. ROOPESH, C. ROTTI, S. SHAH, H. SHISHANGIYA, D. SINGH, N. P. SINGH, H. TYAGI, M. VISHNUDEV, A. YADAV, R. YADAV, G. BANSAL, A. GAHLAUT, V. MAHESH, H. MISTRY, R. PANDEY, K. PANDYA, K. PARMAR, K. PATEL, B. PRAJAPATI, D. SHARMA, J. SONI

*IEEE 26th Symposium on Fusion Engineering (SOFE), 16038992, 2016*

Fabrication of Tungsten & Tungsten Alloy and its High Heat Load Testing for Fusion Applications

S. KANPARA, S. KHIRWADKAR, S. BELSARE, K. BHOPE, R. SWAMY, Y. PATIL, P. MOKARIYA, N. PATEL, T. PATEL, K. GALODIYA

*Materials Today: Proceedings, 3, Part B, 3055, 2016*

Study of Diffusion Bonding of WL10 to SS Joining with and without Titanium Interlayer using Thermo Mechanical Simulator

K. PREMJI SINGH, ALPESH PATEL, KEDAR BHOPE, NIKUNJ PATEL, S.S. KHIRWADKAR

*Materials Today: Proceedings, 3, 2962-2970, 2016*

Data Transfer Methods in Real Time Controller of Ion Cyclotron High Voltage Power Supply

H. DHOLA, A. PATEL, R. DAVE, A. THAKAR, D. PARMAR, K. MEHTA, N. GOSWAMI, N. P. SINGH, S. GAJJAR, U. K. BARUAH  
*IEEE-NPSS Real Time Conference (RT), Padova, Italy, Pages 1 - 3, 2016*

Design and Simulation of Metamaterial Loaded Substrate Integrated Waveguide Fed Patch Antenna for X-Band Military Application

ASHOK KUMAR, GARIMA SAINI, SHAILENDRA SINGH

*International Conference on Wireless Communications, Signal Processing and Networking (WiSPNET), Chennai, pages 550-554, 2016*

A Novel Design of Convex Hexagonal Dielectric Resonator Antenna with Parasitic Plate

PRAMOD KUMAR, SANTANUDWARI, N. K. AGRAWAL, SHAILENDRA SINGH, JITENDRA KUMAR

*International Conference on Wireless Communications, Signal Processing and Networking (WiSPNET), Chennai, pages 547-549, 2016*

IOT Application for Real-Time Monitor of PLC Data using EPICS

RAMESH JOSHI, H. M. JADAV, ANIRUDDH MALI, S. V. KULKARNI

*International Conference on Internet of Things and Applications (IOTA), Pune, Pages 68 - 72, 2016*

Measurement of Outgassing Rate for GTAW Welded SS304 Materials

MOHSIN BUKHARI, SAMIRAN MUKHERJEE, PARESH PANCHAL, RANJANA GANGRADEY, AJIT KUMAR SHUKLA

*IOP Conference Series: Materials Science and Engineering, 149, 12027, 2016*

Efficient Implementation of Empirical Mode Decomposition in FPGA Using Xilinx System Generator

A. AMALIN PRINCE, SRIRAM GANESH, PRAKHAR KUMAR VERMA, PHILIP GEORGE, DANIEL RAJU

*42nd Annual Conference of the IEEE Industrial Electronics Society (IECON 2016), Italy, 23-26 October 2016*

Tungsten Deposition on Graphite Using Plasma Enhanced Chemical Vapour Deposition

UTTAM SHARMA, SACHIN S. CHAUHAN, JAYSHREE SHARMA, A. K. SANYASI, J. GHOSH, K. K. CHOUDHARY and S. K. GHOSH

*Journal of Physics: Conference Series, 755, 012010, 2016*

Study of Trapped Particle Nonlinearity in Ion Acoustic Solitary Wave using Vlasov Simulation

DEBRAJ MANDAL and DEVENDRA SHARMA

*Journal of Physics: Conference Series, 759, 1, 12068, 2016*

Strongly Correlated Classical Plasmas under External Forcing and Dissipation - An Example Using Molecular Dynamics

HARISH CHARAN and RAJARAMAN GANESH

*Journal of Physics: Conference Series, 759, 1, 12061, 2016*

Development of Power Supply for Atmospheric Pressure Plasma Jet at Room Temperature for Bio-Medical Applications

S.C.DAS, A. MAJUMDAR, S. MUKHERJEE, S. KATIYAL, T. SHRIPATHI

*Proceedings of the 10th INDIACom; 2016 3rd International Conference on Computing for Sustainable Global Development, INDIACom 2016, 1207-1209, 2016*

LabVIEW Event Handling using EPICS PV for ICRH DAC Software

RAMESH JOSHI, H M JADAV, ANIRUDDH MALI AND S.V. KULKARNI

*2016 International Conference on Advances in Computing, Communications and Informatics (ICACCI), 1177-1180, 2016*

Design, Analyses, Fabrication and Characterization of Nb<sub>3</sub>Sn Coil in 1 W Pulse Tube

Cryocooler

ANANYA KUNDU, SUBRAT KUMAR DAS, ANEES BANO, NITISH KUMAR and SUBRATA PRADHAN

*IOP Conference Series: Materials Science and Engineering, 171, 012106, 2017*

Performance of Superconducting Current Feeder System for SST-1

A. GARG, H. NIMAVAT, P. SHAH, K. PATEL, D. SONARA, G.L.N. SRIKANTH, N. BAIRAGI, D. CHRISTIAN, R. PATEL, G. MAHESURIA, R. PANCHAL, P. PANCHAL, R. SHARMA, G. PURWAR, G. K. SINGH, V. L. TANNA and S. PRADHAN

*IOP Conference Series: Materials Science and Engineering, 171, 012053, 2017*

Experimental Results of ITER Cold Circulators towards the Performance Demonstration

R. BHATTACHARYA, H. VAGHELA, B. SARKAR, P. PATEL, J. DAS, M. SRINIVASA, T. ISONO, and K. KAWANO

*IOP Conference Series: Materials Science and Engineering, 171, 012058, 2017*

Design of ITER Relief Lines

N. SHAH, K. CHOUKEKAR, M. JADON, B. SARKAR, B. JOSHI, H. KANZARIA, V. GEHANI, H. VYAS, U. PANDYA, R. PANJWANI, S. BADGUJAR, and E. MONNERET

*IOP Conference Series: Materials Science and Engineering, 171, 012056, 2017*

Process Optimization of Helium Cryo Plant Operation for SST-1 Superconducting Magnet System

P. PANCHAL, R. PANCHAL, R. PATEL, G. MAHESURIYA, D. SONARA, L.N. SRIKANTH G, A. GARG, D. CHRISTIAN, N. BAIRAGI, R. SHARMA, K. PATEL, P. SHAH, H. NIMAVAT, G. PURWAR, J. PATEL, V. TANNA and S. PRADHAN

*IOP Conference Series: Materials Science and Engineering, 171, 012024, 2017*

Experimental Investigation of Two-Phase Nitrogen Cryo Transfer Line

G. K. SINGH, H. NIMAVAT, R. PANCHAL, A. GARG, G.L.N. SRIKANTH, K. PATEL, P. SHAH, V. L. TANNA and S. PRADHAN

*IOP Conference Series: Materials Science and Engineering, 171, 012061, 2017*

Cryogenic Heat Loads Analysis from SST-1 Plasma Experiments

N. BAIRAGI, V. L. TANNA and S. PRADHAN

*IOP Conference Series: Materials Science and Engineering, 171, 012060, 2017*

Status of ITER Cryodistribution and Cryoline Project

B. SARKAR, H. VAGHELA, N. SHAH, R. BHATTACHARYA, K. CHOUKEKAR, P. PATEL, H. KAPOOR, M. SRINIVASA, H. S. CHANG, S. BADGUJAR, and E. MONNERET

*IOP Conference Series: Materials Science and Engineering, 171, 012057, 2017*

Design and Fabrication of Indigenous 30 kA Nb<sub>3</sub>Sn CICC for Fusion Relevant Superconducting Magnet

P. RAJ, M. GHATE, S. PRADHAN, A. SINGH, and M. M. HUSSAIN

*IOP Conference Series: Materials Science and Engineering, 171, 012109, 2017*

Acceptance Tests and Their Results for 1st Pre-Series Cryoline (PTCL) Of ITER

H. KAPOOR, A. GARG, N. SHAH, S. MURALIDHARA, K. CHOUKEKAR, B. DASH, V. GAUR, S. MADEENAVALLI, P. PATEL, U. KUMAR, M. JADON, V. SHUKLA, B. SARKAR, Y. SARVAIYA, D. MUKHERJEE, A. DUTTA, KV. MURUGAN, S. GAJERA, B. JOSHI and R. PANJWANI

*IOP Conference Series: Materials Science and Engineering, 171, 012054, 2017*

Development of Indigenous Insulation Material for Superconducting Magnets and Study of its Characteristics



under Influence of Intense Neutron Irradiation

RAJIV SHARMA, V. L. TANNA, C.V.S. RAO, MITUL ABHANGI, SUDHIRSINH VALA, SUNDARAVEL, S. VARATHARAJAN, S. SIVAKUMAR, K. SASI, and S. PRADHAN

*IOP Conference Series: Materials Science and Engineering, 171, 012149, 2017*

Validation Test of Fusion Grade Superconductors

U PRASAD, S PRADHAN, P RAJ, P VARMORA, A PANCHAL, A BANO and M GHATE

*IOP Conference Series: Materials Science and Engineering, 171, 012150, 2017*

Assembly Installation Studies for the ITER Cryoline System  
S BADGUJAR, N SHAH, A FORGEAS, N NAVION-MAILLOT, E MONNERET, D GRILLOT, L BENKHEIRA and B SARKAR

*IOP Conference Series: Materials Science and Engineering, 171, 012051, 2017*

Measurement of Thermal Conductivity of Materials Down To 4.5 K for Development of Cryosorption Pumps

RAVI VERMA, UPENDRA BEHERA, S KASTHURIRENGAN, N C SHIVAPRAKASH, S S UDGATA and R GANGRADEY

*IOP Conference Series: Materials Science and Engineering, 171, 012098, 2017*

Design and Implementation of Electromagnetic Diagnostics Electronics in SST-1 Tokamak

PRAVEENLAL EDAPPALA, CHANDRESH HANSALIA, RACHANA RAJPAL, HITESH MANDALIYA, VISMAY RAULJI, SAMEER KUMAR, RAJU DANIEL

*International Conference on Advances in Electrical, Electronic and Systems Engineering (ICAEES), Malaysia, 14-16 November 2016, Article no.7888090, 2017*

### E.1.3 Book Chapters

Investigation of the Effect of Thermal Cycle on SS/CRZ Brazed Joint Sample

K.P SINGH, ALPESH PATEL, KEDAR BHOPE, S BELSARE, NIKUNJ PATEL, PRAKASH MOKARIA, S.S KHIRWADKAR

Plasma and Fusion Science from Fundamental Research to Technologies Applications, Apple Academic Press, CRC Press, October 2016, **ISBN: 9781771884532** (Book Chapter)

CFD Study on Thermal Hydraulic Performance of a Wavy Channel Based PCHE Model

A.M. ANEESH, ATUL SHARMA, ATUL SRIVASTAVA and PARITOSH CHAUDHURI

Fluid Mechanics and Fluid Power-Contemporary Research, Proceedings of the 5th International and 41st National Conference on FMFP 2014 (Lecture Notes in Mechanical Engineering), pp 497-506, Springer, October 2016, **ISBN: 9788132227410** (Book Chapter)

Thermo-Hydraulic Performance of Zigzag, Wavy, and Serpentine Channel Based PCHEs

A.M. ANEESH, ATUL SHARMA, ATUL SRIVASTAVA and PARITOSH CHAUDHURI

Fluid Mechanics and Fluid Power-Contemporary Research, Proceedings of the 5th International and 41st National Conference on FMFP 2014 (Lecture Notes in Mechanical Engineering), pp.507-516, Springer, October 2016, **ISBN:9788132227410** (Book Chapter)

## E.2 INTERNAL REPORTS

### E.2.1 Research Reports

OBSERVATION OF PLASMA SHIFT IN SST-1 USING OPTICAL IMAGING DIAGNOSTICS

MANOJ KUMAR, CHESTA PARMAR, VISHNU CHAUDHARY, AJAI KUMAR, and SST-1 TEAM  
IPR/RR-789/2016      APRIL 2016

ACTIVATION ANALYSES OF INDIAN LEAD LITHIUM CERAMIC BREEDER TEST BLANKET MODULE IN ITER

A. K. SHAW, H. L. SWAMI and C. DANANI  
IPR/RR-790/2016      APRIL 2016

LEBT OPTIMIZATION FOR BEAM MATCHING STUDIES

MRIDULA MITTAL and RENU BAHL  
IPR/RR-792/2016      APRIL 2016

DESIGN OF COOLING SYSTEM FOR 1 MEV RADIO FREQUENCY QUADRUPOLE

SUMIT KUMAR, RENU BAHL, B. SARKAR and ANURAG SHYAM  
IPR/RR-794/2016      APRIL 2016

- SINGLE PARTICLE CLOSED ORBITS IN YUKAWA POTENTIAL  
RUPAK MUKHERJEE and SOBHAN SOUNDA  
IPR/RR-795/2016 APRIL 2016
- TF RIPPLE ANALYSIS FOR SST-2 LIKE TOKAMAK FUSION REACTOR  
SOMESWAR DUTTA, AASHOO SHARMA, UPENDRA PRASAD, VINAY MENON, C. DANANI, R. SRINIVASAN, S. PRADHAN, S. S. KHIRWADKAR, RAJENDRA KUMAR, S. DESHPANDE, AMITA DAS, D. BORA and P. K. KAW  
IPR/RR-796/2016 APRIL 2016
- USE OF LANGMUIR PROBES IN DUSTY (COMPLEX) PLASMA  
SAYAK BOSE, MANJIT KAUR, P. K. CHATTOPADHYAY, J. GHOSH, Y. C. SAXENA and R. PAL  
IPR/RR-797/2016 APRIL 2016
- STRUCTURAL, MECHANICAL AND CORROSION RESISTANCE PROPERTIES OF TI/TIN BILAYERS DEPOSITED BY MAGNETRON SPUTTERING ON AISI 316L  
K. SHUKLA, R. RANE, J. ALPHONSA, P. MAITY, S. MUKHERJEE and Y. K. AGRAWAL  
IPR/RR-798/2016 APRIL 2016
- COLLISIONLESS SHEATH FEATURES OF CAPACITIVELY COUPLED PLASMA DISCHARGES OPERATING WITH CURRENT DRIVEN TRIPLE FREQUENCY CONFIGURATION  
S. SHARMA, S. K. MISHRA, P. K. KAW and M. M. TURNER  
IPR/RR-799/2016 APRIL 2016
- STUDY OF DIFFUSION BONDING OF WL10 TO SS JOINING WITH & WITHOUT TITANIUM INTERLAYER USING THERMO MECHANICAL SIMULATOR  
K. PREMJI SINGH, ALPESH PATEL, KEDAR BHOPE, NIKUNJ PATEL, S.S KHIRWADKAR  
IPR/RR-801/2016 MAY 2016
- CALCULATED DIFFERENTIAL & DOUBLE DIFFERENTIAL CROSS SECTION OF FUSION NEUTRON INDUCED REACTIONS ON NATURAL CHROMIUM  
MAYANK RAJPUT, BHAWNA PANDEY, CVS RAO, T.K. BASU, and DHIRAJ BORA  
IPR/RR-802/2016 MAY 2016
- THEORETICAL CALCULATION OF DIFFERENTIAL AND DOUBLE DIFFERENTIAL CROSS SECTION OF 14 MeV NEUTRON INDUCED REACTIONS ON Fe  
MAYANK RAJPUT, BHAWNA PANDEY, G. VAITHEESWARAN, CVS RAO, T.K. BASU, and DHIRAJ BORA  
IPR/RR-803/2016 MAY 2016
- TRANSIENT THERMAL, STRUCTURAL AND STATIC MAGNETIC FIELD ANALYSES OF 1:1 PROTOTYPE JET ELM CONTROL COILS  
ANANYA KUNDU, SUBRATA PRADHAN, MAHESH GHATE, DEVEN KANABAR, SWATI ROY, and NITISH KUMAR  
IPR/RR-805/2016 MAY 2016
- BREAKING OF LARGE AMPLITUDE ELECTRON PLASMA WAVE IN A MAXWELLIAN PLASMA  
ARGHYA MUKHERJEE and SUDIP SENGUPTA  
IPR/RR-806/2016 MAY 2016
- MOLECULAR SHEAR HEATING AND VORTEX DYNAMICS IN THERMOSTATED TWO DIMENSIONAL YUKAWA LIQUIDS  
AKANKSHA GUPTA and RAJARAMAN GANESH  
IPR/RR-808/2016 MAY 2016
- ROLE OF THERMAL ANCHORING AND HEAT LOAD OPTIMIZATION OF CONDUCTION COOLED BINARY CURRENT LEAD USED IN CRYO-COOLER  
ANEES BANO, ANANYA KUNDU, SUBRAT KUMAR DAS and SUBRATA PRADHAN  
IPR/RR-809/2016 MAY 2016
- MEASUREMENT OF OUTGASSING RATE FOR GTAW WELDED SS304 MATERIALS  
MOHSIN BUKHARI, SAMIRAN MUKHERJEE, PARESH PANCHAL, AJITKUMAR SHUKLA and RANJANA GANGRADEY  
IPR/RR-810/2016 MAY 2016
- PARTICLE-IN-CELL SIMULATION OF TWO DIMENSIONAL ELECTRON VELOCITY SHEAR DRIVEN INSTABILITY IN RELATIVISTIC DOMAIN  
CHANDRASEKHAR SHUKLA and AMITA DAS  
IPR/RR-811/2016 MAY 2016
- A NOVEL TECHNIQUE TOWARDS FABRICATING HIGH CURRENT CARRYING  $MgB_2$  BASED



- SUPERCONDUCTING JOINTS  
SUBRATA PRADHAN, SUBRAT KUMAR DAS, ANEES BANO and ANANYA KUNDU  
IPR/RR-812/2016            JUNE 2016
- REACTION KINETIC STUDY & ACTIVATION ENERGY CALCULATION OF  $\text{Li}_2\text{TiO}_3$  BY THERMOGRAVIMETRIC MEASUREMENT  
AROH SHRIVASTAVA and PARITOSH CHAUDHURI  
IPR/RR-814/2016            JUNE 2016
- CODE VALIDATION STUDY: 1-D NUCLEAR ANALYSES OF US DCLL TBM USING ANISN CODE AND ITS COMPARISON WITH THE PUBLISHED RESULTS  
DEEPAK AGGARWAL, MAHMOUD Z. YOUSSEF, and CHANDAN DANANI  
IPR/RR-816/2016            JULY 2016
- ON THE NONLINEAR NATURE OF PLASMA INSTABILITY: THE SUBTLETY AND FAILURE OF LINEAR VLASOV APPROACH TO ADDRESS THE ONSET AND GROWTH OF PLASMA INSTABILITY  
HANS SCHAMEL, DEBRAJ MANDAL, and DEVENDRA SHARMA  
IPR/RR-817/2016            JULY 2016
- COLLECTIVE DYNAMICS OF TIME DELAY COUPLED PHASE OSCILLATORS IN A FRUSTRATED GEOMETRY  
BHUMIKA THAKUR, DEVENDRA SHARMA, ABHIJIT SEN and GEORGE L. JOHNSTON  
IPR/RR-818/2016            JULY 2016
- TRANSITION FROM SINGLE TO MULTIPLE AXIAL POTENTIAL STRUCTURE (MAPS) IN EXPANDING HELICON PLASMA  
SOU MEN GHOSH, P. K. CHATTOPADHYAY, J. GHOSH, R. PAL, and D. BORA  
IPR/RR-819/2016            JULY 2016
- ELECTRICAL NETWORKING TECHNIQUE FOR MODELLING OF INDUSTRIAL RF PLASMA AND DEVISING ITS MATCHING NETWORK  
VISHAL JAIN, ANAND VISANI, R. SRINIVASAN and V. AGARWAL  
IPR/RR-821/2016            AUGUST 2016
- INVESTIGATION OF DEFECTS IN ALUMINIZED COATINGS PRODUCED BY PLASMA OXIDATION  
VAIBHAV BHAVSAR, TARANDIPSINGH DANG, HIREN PATEL, BHARATI REHANI, and NIRAV JAMNAPARA  
IPR/RR-822/2016            AUGUST 2016
- ANNULAR PLASMA FORMATION BY MAGNETIC APERTURE IN THE HELICON EXPERIMENTAL (HEX) DEVICE  
SOU MEN GHOSH, S. YADAV, K. K. BARADA, P. K. CHATTOPADHYAY, J. GHOSH, R. PAL and D. BORA  
IPR/RR-823/2016            AUGUST 2016
- NUMERICAL MODELING OF LASER-BLOW-OFF PLUME: LATERAL INTERACTIONS OF TWO PLUMES IN PRESENCE OF BACKGROUND PRESSURE  
SHARAD K. YADAV, BHUPESH KUMAR, BHAVESH G. PATEL, RAJESH K. SINGH, AMITA DAS, PREDHIMAN K. KAW and AJAI KUMAR  
IPR/RR-825/2016            AUGUST 2016
- ATOMISTIC STUDY OF FLOW PAST AN OBSTACLE IN YUKAWA LIQUIDS  
HARISH CHARAN and RAJARAMAN GANESH  
IPR/RR-826/2016            AUGUST 2016
- COLLISIONLESS MICROTearing MODES IN LARGE ASPECT RATIO TOKAMAKS WITH REVERSED SHEAR CONFIGURATIONS  
ADITYA K SWAMY, R. GANESH, S. BRUNNER, J. VACLAVIK and L. VILLARD  
IPR/RR-828/2016            AUGUST 2016
- EXPERIMENTAL OBSERVATION OF PHASE-FLIP TRANSITIONS IN TWO INDUCTIVELY COUPLED GLOW DISCHARGE PLASMAS  
NEERAJ CHAUBEY, S. MUKHERJEE, A. SEN and A. N. SEKAR IYENGAR  
IPR/RR-829/2016            AUGUST 2016
- THE STABILITY OF 1-D SOLITON IN TRANSVERSE DIRECTION  
DEEPA VERMA, RATAN KUMAR BERA, AMITA DAS and PREDHIMAN KAW  
IPR/RR-831/2016            SEPTEMBER 2016
- NONLINEAR EFFECTS IN THE BOUNDED DUST VORTEX FLOW IN PLASMA  
MODHUCHANDRA LAISHRAM, DEVENDRA SHARMA and PREDHIMAN K. KAW  
IPR/RR-832/2016            SEPTEMBER 2016

- SIMULTANEOUS MEASUREMENT OF THERMAL DIFFUSIVITY & SPECIFIC HEAT OF  $\text{Li}_2\text{TiO}_3$  CERAMIC PELLET  
AROH SHRIVASTAVA, NARENDER SINGH and P. CHAUDHURI  
IPR/RR-834/2016 SEPTEMBER 2016
- OBSERVATION OF MODE TRANSITION AND LOW FREQUENCY OSCILLATIONS IN MAGNETICALLY CONSTRICTED ANODE  
S. CHAUHAN, M. RANJAN, M. BANDYOPADHYAY and S. MUKHERJEE  
IPR/RR-835/2016 OCTOBER 2016
- IDENTIFICATION AND REMOVAL OF UNWANTED SIGNALS IN PULSED MEASUREMENT  
SAYAK BOSE, MANJIT KAUR, K. K. BARADA, J. GHOSH and P. K. CHATTOPADHYAY  
IPR/RR-836/2016 OCTOBER 2016
- STUDY OF DYNAMICAL BEHAVIOUR OF THE PLASMA IN A DC NON-TRANSFERRED PLASMA TORCH USING FAST IMAGING  
VIDHI GOYAL, G. RAVI, P. BANDYOPADHYAY, S. BANERJEE, YUGESH V. and S. MUKHERJEE  
IPR/RR-837/2016 OCTOBER 2016
- STUDY OF ION-ION COUNTER STREAMING INSTABILITY IN PRESHEATH-SHEATH REGION OF A MESH GRID IMMERSSED IN LOW TEMPERATURE PLASMA  
VARA PRASAD KELLA, J. GHOSH, P. K. CHATTOPADHYAY, D. SHARMA and Y. C. SAXENA  
IPR/RR-838/2016 OCTOBER 2016
- INFLUENCE OF ARC CURRENT ONTO THE FORMATION OF COBALT BASED NANOSTRUCTURES USING DC ARC DISCHARGE  
P. B. ORPE and C. BALASUBRAMANIAN  
IPR/RR-839/2016 OCTOBER 2016
- DESIGN AND SIMULATION OF FEEDBACK CONTROL SYSTEM FOR GENERATING REGULATED HIGH VOLTAGE FOR MAGNETRON IN MICROWAVE APPLICATIONS  
VISHAL JAIN, MOHIT VAGADIA, CHIRAG GUJARATI, SAIFALI DALKOTI and VIVEK AGARWAL  
IPR/RR-840/2016 NOVEMBER 2016
- SPINS-IND: PELLET INJECTOR FOR FUELING OF MAGNETICALLY CONFINED FUSION SYSTEMS  
RANJANA GANGRADEY, JYOTISHANKAR MISHRA, SAMIRAN MUKHERJEE, PARESH PANCHAL, PRATIK NAYAK and JYOTI AGARWAL  
IPR/RR-841/2016 NOVEMBER 2016
- OBSERVATION OF LARGE FILAMENTS DURING THE DISRUPTIVE PHASE OF ADITYA TOKAMAK PLASMA  
SANTANU BANERJEE, N. BISAI, D. CHANDRA, P. DHYANI, R. MANCHANDA, M. B. CHOWDHURI, N. RAMAIYA, N. PARMAR, D. SANGWAN, J. GHOSH, R. L. TANNA, P. K. CHATTOPADHYAY, D. RAJU, P. K. ATREY, Y. SHANKAR JOISA, A. SEN, P. K. KAW and THE ADITYA TEAM  
IPR/RR-842/2016 NOVEMBER 2016
- NUCLEAR ANALYSES OF NEUTRON ACTIVATION SYSTEM FOR INDIAN TBM  
H. L. SWAMI, A. K. SHAW, A. N. MISTRY, S. TIWARI and C. DANANI  
IPR/RR-843/2016 DECEMBER 2016
- EXPERIMENTAL OBSERVATION OF SELF EXCITED CO-ROTATING MULTIPLE VORTICES IN A DUSTY PLASMA WITH INHOMOGENEOUS PLASMA BACKGROUND  
MANGILAL CHOUDHARY, S. MUKHERJEE and P. BANDYOPADHYAY  
IPR/RR-844/2016 DECEMBER 2016
- TWO DIRECTIONAL FAST IMAGING OF PLASMA PLUME IN VARIABLE MAGNETIC FIELD: STRUCTURE AND DYNAMICS OF THE PLUME IN DIAMAGNETIC AND NON-DIAMAGNETIC LIMITS  
NARAYAN BEHERA, R. K. SINGH, V. CHAUDHARI and AJAI KUMAR  
IPR/RR-845/2016 DECEMBER 2016
- NONLINEAR SIMULATION OF ELM DYNAMICS IN THE PRESENCE OF RESONANT MAGNETIC PERTURBATIONS  
D. CHANDRA, A. THYAGARAJA, A. SEN and P. KAW  
IPR/RR-846/2016 DECEMBER 2016
- DESTABILIZATION OF A CYLINDRICALLY CONFINED ELECTRON CLOUD BY IMPACT IONIZATION OF BACKGROUND NEUTRALS: 2D3V PIC SIMULATION WITH MONTE-CARLO-COLLISIONS



- M. SENGUPTA and R. GANESH  
IPR/RR-847/2016                      DECEMBER 2016
- PREDICTION OF OPERATIONAL CHARACTERISTICS OF A DC NON-TRANSFERRED ARC PLASMA TORCH USING SIMILARITY CRITERIA  
V. YUGESH, G. RAVI and K. RAMACHANDRAN  
IPR/RR-848/2016                      DECEMBER 2016
- DRIVEN PHASE SPACE VORTICES IN PLASMAS WITH NONEXTENSIVE VELOCITY DISTRIBUTION  
PALLAVI TRIVEDI and RAJARAMAN GANESH  
IPR/RR-849/2016                      DECEMBER 2016
- INVESTIGATION OF NEUTRAL PARTICLE DYNAMICS IN ADITYA TOKAMAK PLASMA WITH DEGAS2 CODE  
RITU DEY, JOYDEEP GHOSH, M. B. CHOWDHURI, R. MANCHANDA, S. BANERJEE, N. RAMAIYA, DEEPTI SHARMA, R. SRINIVASAN, D. P. STOTLER and ADITYA TEAM  
IPR/RR-850/2017                      JANUARY, 2017
- NEUTRAL GAS ON SCRAPE-OFF LAYER TOKAMAK PLASMA TURBULENCE  
N. BISAI and P. K. KAW  
IPR/RR-851/2017                      JANUARY, 2017
- STUDY OF RAMP RATE LIMITATION AND CURRENT RE-DISTRIBUTION IN YBCO HIGH  $T_c$  TRIPLET SUPERCONDUCTING SUB-CABLE  
UPENDRA PRASAD, S. PRADHAN and P. VARMORA  
IPR/RR-852/2017                      JANUARY, 2017
- SIMULATION OF TOROIDAL ERROR FIELDS IN ADITYA-U TOKAMAK  
A. AMARDAS, D. RAJU, J. GHOSH and ADITYA TEAM  
IPR/RR-853/2017                      JANUARY, 2017
- DESIGN AND SIMULATION OF FEEDBACK SYSTEM TO GENERATE PLASMA ARC IN CURRENT SOURCE MODE  
VISHAL JAIN, S. K. NEMA and VIVEK AGARWAL  
IPR/RR-854/2017                      JANUARY, 2017
- EFFECTIVE THERMAL CONDUCTIVITY MEASUREMENT OF LITHIUM META TITANATE PEBBLE BED USING TRANSIENT HOT WIRE TECHNIQUE  
MAULIK PANCHAL and P. CHAUDHURI  
IPR/RR-855/2017                      JANUARY, 2017
- MODELING OF EDDY CURRENT DISTRIBUTION IN THE SST-1 TOKAMAK  
AMIT K. SINGH, SANTANU BANERJEE, I. BANDYOPADHYAY, DEEPTI SHARMA, S. K. JHA, R. SRINIVASAN, D. RAJU, M. V. GOPALAKRISHNA and the SST-1 TEAM  
IPR/RR-856/2017                      JANUARY, 2017
- OBSERVATION OF THE KORTWEG-DE VRIES SOLITON IN MOLECULAR DYNAMICS SIMULATIONS OF A DUSTY PLASMA MEDIUM  
SANDEEP KUMAR, SANAT KUMAR TIWARI and AMITA DAS  
IPR/RR-857/2017                      JANUARY, 2017
- SYNTHESIS AND CHARACTERIZATION OF PURE TUNGSTEN BY HIGH TEMPERATURE SINTERING USING GLEEBLE 3800 SYSTEM  
ALPESH PATEL, SHAILESH KANPARA, KEYUR PATEL and S. S. KHIRWADKAR  
IPR/RR-858/2017                      JANUARY, 2017
- INTERACTION AND PROPAGATION CHARACTERISTICS OF TWO COUNTER AND CO-PROPAGATING MACH CONES IN A DUSTY PLASMA  
P. BANDYOPADHYAY, R. DEY and A. SEN  
IPR/RR-859/2017                      JANUARY, 2017
- DESIGN AND DEVELOPMENT OF FMCW REFLECTOMETRY FOR SST-1 TOKAMAK AT IPR  
JJU BUCH and S. K. PATHAK  
IPR/RR-860/2017                      FEBRUARY, 2017
- OBSERVATION OF REFLECTED ELECTRONS DRIVEN QUASI- LONGITUDINAL (QL) WHISTLERS IN LARGE LABORATORY PLASMA  
A. K. SANYASI, L. M. AWASTHI, P. K. SRIVASTAVA, S. K. MATTOO, D. SHARMA, R. SINGH, R. PAIKARAY and P. K. KAW  
IPR/RR-861/2017                      FEBRUARY, 2017
- STRUCTURAL DESIGN OPTIMIZATION OF BREEDER UNIT MODULE SIZE FOR THE INDIAN HCCB BLANKET MODULE  
DEEPAK SHARMA, PARITOSH CHAUDHURI and ALICE YING  
IPR/RR-862/2017                      FEBRUARY, 2017
- STRUCTURAL DESIGN AND ANALYSIS OF THE

- COOLING HELIUM MANIFOLDS FOR INDIAN HCCB BLANKET MODULE  
DEEPAK SHARMA, PARITOSH CHAUDHURI and ALICE YING  
IPR/RR-863/2017 FEBRUARY, 2017
- EXPERIMENTAL EVALUATION OF THE EFFECTIVE THERMAL CONDUCTIVITY FOR LITHIUM METATITNATE PEBBLE BED UNDER HELIUM GAS ENVIRONMENT  
MAULIK PANCHAL, A. SARASWAT, S. VERMA, M. MAKWANA and P. CHAUDHURI  
IPR/RR-864/2017 FEBRUARY, 2017
- MEASUREMENT OF LOW TEMPERATURE THERMAL PROPERTIES OF INSULATION MATERIAL G10 USED FOR CRYOGENIC APPLICATIONS  
JYOTI AGARWAL, JYOTISHANKAR MISHRA, VRUSHABH LAMBADE, S. KASTURIRANGAN, RANJANA GANGRADEY and SAMIRAN MUKHERJEE  
IPR/RR-865/2017 FEBRUARY, 2017
- SIMULTANEOUS MEASUREMENT OF THERMAL DIFFUSIVITY AND HEAT CAPACITY OF IN-RAFM STEEL USING LASER FLASH APPARATUS  
NARENDER SINGH, C. S. SASMAL, AROH SHRIVASTAVA and P. CHAUDHURI  
IPR/RR-866/2017 FEBRUARY, 2017
- VALIDATION OF COMSOL CODE FOR ANALYZING LIQUID METAL MAGNETO-HYDRO-DYNAMIC FLOW  
S. SAHU and R. BHATTACHARYAY  
IPR/RR-867/2017 FEBRUARY, 2017
- EFFECT OF ION MOTION ON RELATIVISTIC ELECTRON BEAM DRIVEN WAKEFIELD IN A COLD PLASMA  
RATAN KUMAR BERA, SUDIP SENGUPTA and AMITA DAS  
IPR/RR-868/2017 MARCH, 2017
- OPTIMIZATION OF TRITIUM BREEDING PERFORMANCE OF VARIOUS BREEDING BLANKET CONCEPTS FOR INDIAN DEMO  
H. L. SWAMI and C. DANANI  
IPR/RR-869/2017 MARCH, 2017
- DESIGN, DEVELOPMENT AND OPERATION OF SEVEN CHANNELS 100 GHZ INTERFEROMETER FOR PLASMA DENSITY MEASUREMENT  
P. K. ATREY, DHAVAL PUJARA, SUBROTO MUKHERJEE and RAKESH L. TANNA  
IPR/RR-870/2017 MARCH, 2017
- LANTHANUM BROMIDE (LaBr<sub>3</sub> (Ce)) BASED HARD X-RAY SPECTROSCOPIC DIAGNOSTIC TO STUDY THE RUNAWAY ELECTRONS AT ADITYA TOKAMAK  
S. PUROHIT, Y. S. JOISA, J. V. RAVAL, M. B. CHOWDHURI, U. C. NAGORA, P. K. ATREY, R. L. TANNA, K. A. JADEJA, S. B. BHATT, C. N. GUPTA, M. B. KALAL, A. KUMAR, J. GHOSH and ADITYA TEAM  
IPR/RR-871/2017 MARCH, 2017
- INFLUENCE OF GAS INJECTION CONFIGURATION ON THE CHARACTERISTICS OF ADC NONTRANSFERRED PLASMA TORCH  
YUGESH V., G. RAVI, K. C. MEHER, VIDHI GOYAL and K. RAMACHANDRAN  
IPR/RR-872/2017 MARCH, 2017
- A NEW LINEAR DEVICE FOR THE STUDY OF STRUCTURES IN ELECTRON MAGNETOHYDRODYNAMIC REGIME  
GARIMA JOSHI, G. RAVI and S. MUKHERJEE  
IPR/RR-873/2017 MARCH, 2017
- OVERVIEW OF RECENT EXPERIMENTAL RESULTS FROM ADITYA TOKAMAK  
R. L. TANNA, J. GHOSH, P. K. CHATTOPADHYAY, HARSHITA RAJ, SHARVIL PATEL, P. DHYANI, C.N. GUPTA, K. A. JADEJA, K.M. PATEL, S.B. BHATT, V. K. PANCHAL, N. C. PATEL, CHHAYA CHAVDA, PRAVEENLAL E.V., K. S. SHAH, M. N. MAKAWANA, S.K. JHA, M. V. GOPALKRISHANA, K. TAHILIANI, DEEPAK SANGWAN, D. RAJU, UMESH NAGORA, S.K. PATHAK, P. K. ATREY, S. PUROHIT, J. RAVAL, Y. S. JOISA, C.V.S. RAO, M. B. CHOWDHURI, S. BANERJEE, N. RAMAIYA, R. MANCHANDA, J. THOMAS, AJAI KUMAR, KUMAR AJAY, P. K. SHARMA, S.V. KULKARNI, K. SATHYANARAYANA, B.K. SHUKLA, AMITA DAS, R. JHA, Y.C. SAXENA, A. SEN, P. K. KAW, D. BORA and the ADITYA TEAM  
IPR/RR-874/2017 MARCH, 2017
- MHD MODE COUPLING IN DENSITY FLUCTUATION IN ADITYA DISCHARGES  
PRAVEEN KUMAR ATREY, DHAVAL PUJARA and S. MUKHERJEE  
IPR/RR-875/2017 MARCH, 2017

1-D NUCLEAR ANALYSIS OF ITER USING 1-D AND 3-D DETERMINISTIC CODES AND THEIR COMPARISON WITH THE PUBLISHED RESULTS

SHAHRUKH BAREJIA, DEEPAK AGGARWAL, CHANDAN DANANI and R. SRINIVASAN

IPR/RR-876/2017 MARCH, 2017

## E 2.2 Technical Reports

Optimisation of Thermal Zone of 3-Stream (He-He-He) Platefin Heat Exchanger for Helium Plant

A. K. SAHU, O. MAHAPATRA, P SHARMA, B. V. SHAH and R. K. SAHOO

IPR/TR-379/2016 (APRIL 2016)

Finding Friction Factor for Low Temperature Helium Flow through Serrated Type Plate-Fin Heat Exchanger Using CFD

B. V. SHAH, A. K. SAHU, N. MAMGAIN, S. V. JAIN and P. SHARMA

IPR/TR-380/2016 (APRIL 2016)

Development of Prototype Nb<sub>3</sub>Sn Praying Hand Joint for SST-1 New Superconducting Central Solenoid Winding Pack

U. PRASAD, A. PANCHAL, P. RAJ, P. VARMORA and S. PRADHAN

IPR/TR-381/2016 (APRIL 2016)

Conceptual Design Report for Development of Hydrogen Isotopes Removal System

V. GAYATHRI DEVI, DEEPAK YADAV, and AMIT SIRCAR

IPR/TR-382/2016 (APRIL 2016)

Sealing Performance of Non-Metallic Gaskets with Indium Wire Seal at Temperatures Down to 10K for High Vacuum and Thermal Insulation Application in a Screw Extruder System

PARESH PANCHAL, SAMIRAN SHANTI MUKHERJEE, PRATIK NAYAK, JYOTI SHANKAR MISHRA, JYOTI AGRAWAL, and RANJANA GANGRADEY

IPR/TR-383/2016 (MAY 2016)

Establishment and Validation of "Unit for Thermal Properties Assessment at Low Temperature" (UTPAL) at IPR

JYOTI AGARWAL, JYOTISHANKAR MISHRA, VRUSHABH LAMBADE, S. KASTURIRANGAN, RANJANA GANGRADEY and SAMIRAN MUKHERJEE

IPR/TR-384/2016 (MAY 2016)

Kinetics Studies of Carbon Doped Amorphous Nano- Boron in MgB<sub>2</sub> Phase

NITISH KUMAR, SUBRAT KUMAR DAS and SUBRATA PRADHAN

IPR/TR-385/2016 (JUNE 2016)

Hollow Circular Acrylic Waveguides for Far Infrared Interferometer of SST-1

ASHA ADHIYA, RAJWINDER KAUR and PABITRA KUMAR MISHRA

IPR/TR-386/2016 (JUNE 2016)

Development, Optimization and Validation of Ultrasonic Testing for NDE of ELM Coils

K. BHOPE, M. GHATE, M. MEHTA, A. PANCHAL, S. PRADHAN and S. KHIRWADKAR

IPR/TR-387/2016 (JUNE 2016)

Design Study of a Vacuum Chamber for Hydrogen Solidification System

SANDIP ROY, JYOTISHANKAR MISHRA, RANJANA GANGARADEY and KARTIK KOTHARI

IPR/TR-388/2016 (JUNE 2016)

FPGA Based Electronics for Controlling High Voltage Biasing of Photomultiplier Tube Detector in Spectroscopy Diagnostic

MINSHA SHAH, HITESH MANDALIYA, RACHANA RAJPAL and ELECTRONICS GROUP

IPR/TR-389/2016 (JUNE 2016)

Design and Development of LN<sub>2</sub> Based Hydrogen Gas Pre-Cooler, with its Initial Experimental Study using Helium Gas

P. NAYAK, S. MUKHERJEE, P. PANCHAL, D. TRIPATHI, R. GANGRADEY, J. MISHRA and J. AGARWAL

IPR/TR-390/2016 (JUNE 2016)

Gated Integrator PXI-DAQ System for Thomson Scattering Diagnostics

KIRAN PATEL, VISHAL PILLAI, NEHA SINGH, JINTO THOMAS and AJAI KUMAR

IPR/TR-391/2016 (JUNE 2016)

Conceptual Design of Cuboid Shaped Vacuum Cryostat for Twin Screw Hydrogen Extruder

PARESH PANCHAL, DEVESH TRIPATHI, SAMIRAN MUKHERJEE and RANJANA GANGRADEY

IPR/TR-392/2016 (JULY 2016)

Conceptual Design Report of Experimental Loop for Hydrogen Isotopes Extraction from Liquid Pb-Li  
RUDREKSH B. PATEL, SUDHIR RAI and AMIT SIRCAR  
IPR/TR-393/2016 (JULY 2016)

Development and Testing of Visual Inspection Applications for Tokamak Maintenance  
PRAMIT DUTTA, NAVEEN RASTOGI, SHREYA JOSHI, AKSHAY PATEL, MIHIR TRIVEDI and K. K. GOTEWAL  
IPR/TR-394/2016 (JULY 2016)

Open Loop Control of Filament Heating Power Supply for Large Volume Plasma Device  
R. SUGANDHI, P. K. SRIVASTAVA, A. K. SANYASI, P. SRIVASTAV, L. M. AWASTHI and S. K. MATTOO  
IPR/TR-395/2016 (AUGUST 2016)

Data Acquisition System for LN<sub>2</sub> Cool Down Experiment for 6 Nos. of Cryogenics Pumps  
KARISHMA QURESHI, P. J. PATEL, C. CHAKRAPANI, S. L. PARMAR, L. K. BANSAL, B. PANDYA, DIPAL THAKKAR, C. B. SUMOD, L. N. GUPTA, VIJAY VADHER, B. CHOKSI, NILESH CONTRACTOR, S. K. SHARMA, SRIDHAR, RAMBABU, BHARATHI, M. R. JANA, V. PRAHLAD and U. K. BARUAH  
IPR/TR-396/2016 (AUGUST 2016)

Artificial Neural Network for Yield Strength Prediction of Irradiated RAFM Steels  
H. T. IYER and A. ABHISHEK  
IPR/TR-397/2016 (AUGUST 2016)

Electromagnetic and Structural Analysis of Jet Elm Control Coil Support Structure  
PRAMIT DUTTA, MANOAHSTEPHEN MANUELRAJ, NAVEEN RASTOGI and CHRISTOPHER LOWRY  
IPR/TR-398/2016 (SEPTEMBER 2016)

Preliminary Design and Assessment of Beam Tube for Laser Interferometer Gravitational Wave Observatory (LIGO)-India Project  
RAKESH KUMAR, YUVAKIRAN PARAVASTU and ZIAUDDIN KHAN  
IPR/TR-399/2016 (SEPTEMBER 2016)

Development of Driver Amplifier Stage for Generator of the ADITYA ICRH System  
SUNIL KUMAR, D. BORA, S.V. KULKARNI and HIGH POWER ICRH SYSTEMS DIVISION  
IPR/TR-400/2016 (SEPTEMBER 2016)

Development of Pre-Driver Amplifier Stage for Generator of the ADITYA ICRH System  
SUNIL KUMAR, D. BORA, S.V. KULKARNI and HIGH POWER ICRH SYSTEMS DIVISION  
IPR/TR-401/2016 (SEPTEMBER 2016)

Development and Testing Of Prototype Soft X-Ray Camera Using 16channel AXUV Photodiode Array for Aditya Tokamak  
JAYESH RAVAL, S. PUROHIT, Y.S. JOISA, A.K. CHATTOPADHYAY, PRAVEENA KUMARI, VISMAYSINH RAULJI, MINSHA SHAH and RACHANA RAJPAL  
IPR/TR-402/2016 (SEPTEMBER 2016)

Specimen Preparation Procedure for Studies using Transmission Electron Microscope (TEM)  
A. SATYAPRASAD, C. BALASUBRAMANIAN and S. MUKHERJEE  
IPR/TR-403/2016 (OCTOBER 2016)

Low Cost, Light Weight 100kV Galvanic Isolated Control Power Supplies  
BHAVESH R. KADIA, K. M. PARMAR, Y. S. S. SRINIVAS and S. V. KULKARNI  
IPR/TR-404/2016 (OCTOBER 2016)

Study of Requirement and Possibility of using Mechanical and Temperature Sensors on LLCB TBM  
RITESH KUMAR SRIVASTAVA and PARITOSH CHAUDHURI  
IPR/TR-405/2016 (OCTOBER 2016)

Outgassing Measurement of Various Activated Carbon Sorbents for Application in Prototype Cryopump  
PARESH PANCHAL, SAMIRAN MUKHERJEE and RANJANA GANGRADEY  
IPR/TR-406/2016 (NOVEMBER 2016)

Electron Beam Welding Scenario: Non - Vacuum / Partial Vacuum  
GAUTAM R. VADOLIA and K. P. SINGH  
IPR/TR-407/2016 (NOVEMBER 2016)

Implementation of Object Oriented Software Engineering on Labview Graphical Design Framework for Data Acquisition in Large Volume Plasma Device  
R. SUGANDHI, P. K. SRIVASTAVA, PRABHAKAR SRIVASTAV, A. K. SANYASI, L. M. AWASTHI, V.

PARMAR, K. MAKADIA, I. PATEL and S. SHAH  
IPR/TR-408/2016 (NOVEMBER 2016)

Design and Analysis of Manifolds for Indian HCCB Blanket Module

DEEPAK SHARMA, PARITOSH CHAUDHURIA, ALICE YING  
IPR/TR-409/2016 (NOVEMBER 2016)

Virtual Reality Applications in Remote Handling Development for Tokamaks in India

PRAMIT DUTTA, NAVEEN RASTOGI and KRISHAN KUMAR GOTEWAL  
IPR/TR-410/2016 (DECEMBER, 2016)

Design and Optimization Study of First Wall for Indian HCCB Blanket Module

DEEPAK SHARMA, PARITOSH CHAUDHURI and ALICE YING  
IPR/TR-411/2016 (DECEMBER, 2016)

Design of Efficient Oil Coalescer for Helium Compressor and Oil Removal System

V.B PATEL, A.K SAHU and K. PURANI  
IPR/TR-412/2016 (DECEMBER, 2016)

A Technical Report on Radiation Shielding Calculation for the LINAC facility (IPR-SPEAR)

LALIT GUPTA, M. K. NAYAK, HARIDAS G. and RAVI A. V. KUMAR  
IPR/TR-413/2016 (DECEMBER, 2016)

Development of a Prototype Work-Cell for Validation of ITER Remote Handling Control System Standards

NAVEEN RASTOGI, VAMSHI KRISHNA, PRAMIT DUTTA, MANOAH STEPHEN, KRISHAN KUMAR GOTEWAL, DAVID HAMILTON and J. K. MUKHERJEE  
IPR/TR-414/2016 (DECEMBER, 2016)

Development of Output Amplifier Stage for Generator of the Aditya ICRH System

SUNIL KUMAR, D. BORA, S. V. KULKARNI and HIGH POWER ICRH SYSTEMS DIVISION  
IPR/TR-415/2017 (JANUARY, 2017)

Design, Fabrication and Initial Testing of the Output Amplifier Stage for Generator of the SST-1 ICRH System

SUNIL KUMAR, D. BORA, S.V. KULKARNI and HIGH POWER ICRH SYSTEMS DIVISION  
IPR/TR-416/2017 (JANUARY, 2017)

Lab Scale Experiment Study to Explore Thermal Deformation of P91 Structural Material with the use of Strain Gauges

RITESH KUMAR SRIVASTAVA, ABHISHEK SARASWAT and PARITOSH CHAUDHURI  
IPR/TR-417/2017 (FEBRUARY, 2017)

Apparent Porosity and Bulk Density Measurement of Lithium Meta-Titanate Pebbles by Kerosene Intrusion & Archimedes Method

MAYANK MAKWANA, A. SHRIVASTAVA, M. PANCHAL, P. CHAUDHURI and E. RAJENDRAKUMAR  
IPR/TR-418/2017 (MARCH, 2017)

Concept of Twin Screw Extruder for Solid Hydrogen Extrusion

SAMIRAN SHANTI MUKHERJEE, RANJANA GANGRADEY, DEVESH TRIPATHI, PARESH PANCHAL, PRATIK NAYAK, JYOTI SHANKAR MISHRA, JYOTI AGARWAL and KRISHANPAL PATIDAR  
IPR/TR-419/2017 (MARCH, 2017)

SST-1 NBI: 6 Cryopumps Parallel Cooldown and Operational testing with LN<sub>2</sub>

CH. CHAKRAPANI, B. SRIDHAR, P. BHARGAV, Q. KARISHMA, C. NILESH, P. SANJAY and C. BHARGAV  
IPR/TR-420/2017 (MARCH, 2017)

A Report on Crush Load of Lithium Ceramic Pebbles

SURAJ KUMAR GUPTA, MAULIK PANCHAL, RISCOB JAMES BRIGHT, AROH SRIVASTAVA, MAYANK MAKWANA and PARITOSH CHAUDHURI  
IPR/TR-421/2017 (MARCH, 2017)

FPGA Based Reconfigurable Digital Filter in Measurement System for Plasma Diagnostic

AARTI N. ODEDARA, V. CHAUDHARI and A. H. DAFDA  
IPR/TR-422/2017 (MARCH, 2017)

Radiation Heat Transfer Studies for Dome Fabrication Project

DEEPU S. KRISHNAN, K. P. SINGH, S. S. KHIRWADKAR and VINAY MENON  
IPR/TR-423/2017 (MARCH, 2017)

Investigation on Turbulent Heat Transfer in Developing Flow Regime for Counter Current Arrangement in Double Pipe Heat Exchanger (Concentric Annulus) for PbLi Liquid Metal

ARVIND KUMAR, V. MEHTA, A. K. PRAJAPATI, A. SARASWAT, S. VERMA, R. BHATTACHARYAY, V. C. CHAUDHARI, K. T. SANDEEP, A. JAISWAL and S. GUPTA  
IPR/TR-424/2017 (MARCH, 2017)

Tensile Testing of Pure Tungsten Material at Elevated Temperatures using Small Specimen

ALPESH PATEL, DHAVAL MAKVANA and S. S. KHIRWADKAR  
IPR/TR-425/2017 (MARCH, 2017)

Refurbishment, Testing and Experiments on Ion Removal System Magnet of SST-1 NBI

SANJEEV SHARMA, BHARGAV CHOKSI, S. RAMBABU, SANJAY PARMAR, V. PRAHLAD and U. K. BARUAH  
IPR/TR-426/2017 (MARCH, 2017)

Study of Spectral Characteristics and Operating Parameters of Twin Cavity CH<sub>3</sub>OH Laser for FIR Diagnostics of SST-1

ASHA ADHIYA and RAJWINDER KAUR  
IPR/TR-427/2017 (MARCH, 2017)

### E.3 CONFERENCE PRESENTATION

*19th Joint Workshop (EC-19) on Electron Cyclotron Emission (ECE) and Electron Cyclotron Resonance Heating (ECRH), Institute for Plasma Research, Gandhinagar, 4-7 April 2016*

Numerical Study on Contribution of Non-Thermal Electrons on ITER ECE Spectrum and Attempt to Parametrically Correlate it to Non-Thermal Parameters through Asymmetric Multiple Measurements

P.V. Subhash, Amit K. Singh, V.S. Divya, M.P. Aparna, T.K. Basitha Thanseem, Hitesh Pandya

Numerical Evaluation of Temperature Fluctuations due to NTM in the ECE Spectrum using a Combination of Perpendicular and Multiple Oblique Views

Amit K. Singh, P.V. Subhash, I. Bandyopadhyay

Trapped Particle Effects on Electron Cyclotron Current Drive

J.K. Atul, S. Sarkar, O.V. Kranvchenko, and S.K. Singh

Study of Edge Turbulence in ECRH Driven Slab Annular Plasma in SST-1

Santanu Banerjee, Navin Parmar, B.K. Shukla, M.V. Gopalakrishna, Jatin Patel, R. Manchanda, M.B. Chowdhuri, N. Ramaiya, S.K. Jha, J. Ghosh and SST-1 team

ECRH Induced Plasma Rotation Dynamics in Open and Closed Magnetic Field Configuration in Tokamak QUEST

Kishore Mishra, H. Zushi, H. Idei, T. Onchi, K. Hanada and QUEST Team

Status and Test Results of Indigenously Developed 42 GHz, 200 kW, 3 Sec. Gyrotron

S.V. Kulkarni, Rajan Babu, S. Pradhan, B.K. Shukla, K. Sathyanarayana, Nidhi Shah, Ejazuddin Shaik, Hetshree Shah, Harshida Patel, Piyush Raj, Upendra Prasad, Mahesh Ghate, Yohan Khristi, Moni Banaudha, Arun Panchal, Dhaval Panchal, D. Rathi and D. Bora

Update on the Status of the ITER ECE Diagnostic Design

G. Taylor, A. Basile, R. Feder, D.W. Johnson, A. Khodak, H.K. Pandya, S. Danani, R. Kumar, S. Kumar, S.B. Padasalagi, S. Thomas, M.E. Austin, S. Houshmandyar, P.E. Phillips, W.L. Rowan, J.H. Beno, A. Ouroua, D. Weeks, A.E. Hubbard, J. Stillerman, V.S. Udintsev, G. Vayakis, M. Walsh

Testing of the Prototype Receiver for ITER ECE Diagnostic

S. Danani, M.E. Austin, M.W. Brookman, H.K.B. Pandya, Vinay Kumar

Characterization of In-house Developed High Temperature Black Body Source in Frequency Range 70-1000GHz

Ravinder Kumar, S. Danani, Shivakant Jha, Sajal Thomas, Dass Sudhir Kumar, Hitesh Pandya, Vinay Kumar

In-Lab Calibration of Michelson Interferometer Diagnostics for Broadband ECE Measurement

Abhishek Sinha, S.K. Pathak, Stefan Schmuck and John Fessey

ECE Measurement Systems at IPR

S. Varsha and S.K. Pathak

A Design Approach to External Mode Conversion with Sensitivity Analysis for 42GHz Gyrotron

K. Sathyanarayana, Nidhi Shah, S.V. Kulkarni and D. Bora

Anode Modulator Power Supply (AMPS) along with a Crowbar Protection System for 82.6 GHz and 42 GHz Gyrotron

N. Rajanbabu, B.K. Shukla, Jatin Patel, Harshida Patel, Dharmesh Purohit, Pragnesh Dhorajiya

Design, Development and Functional Validation of Magnets System in Support of 42 GHz Gyrotron in India

Subrata Pradhan, Sunil Kedia, Upendra Prasad, Piyush Raj, Mahesh Ghate, Yohan Khristi, Arun Panchal, Moni Banudha, Dhaval Bhavsar, B K Shukla and Dhiraj Bora



Overview and Status of ITER-India EC RF Source Package for ITER

S.L. Rao, Vipal Rathod, Anjali Sharma, Ronak Shah, Deepak Mandge, Sharan Dilip, Amit Yadav and Rajiv Parmar

Primary Window Assemblies for Microwave Diagnostics on ITER

V.S. Udintsev, P. Maquet, T. Cornut, J.W. Oosterbeek, A. Sirinelli, N. Casal, B. Conway, J-M Drevon, G. Eaton, T. Giacomini, J. Guirao, S. Hughes, M. Dapena, H.K.B. Pandya, D. Shelukhin, G. Taylor, C. Vacas, G. Vayakis, V. Vershkov, M.J. Walsh

Commissioning of PXI based Data Acquisition and Control System for ECRH

Jatinkumar Patel, H. Patel, P. Dhorajiya, N. Rajanbabu, D. Purohit, B.K. Shukla

Design and analysis of steerable ECRH Launcher for SST-1 Tokamak

Hardik Mistry and B.K. Shukla

ITER-India Gyrotron Test Facility (IINTF): Overview and Status

Vipal Rathod, S.L. Rao, Anjali Sharma, Ronak Shah, Deepak Mandge, Sharan Dilip, Amit Yadav and Rajiv Parmar

Prototype Development of Gyrotron Body Power Supply Using HV Switches for ITER-India Gyrotron Test Facility (IIGTF)

Sharan Dilip, Vipal Rathod, Ronak Shah, Deepak Mandge, Amit Yadav, Anjali Sharma, Rajiv Parmar, Darshan Parmar, NP Singh, S.L. Rao, and Ujjwal Baruah

Overview and Status of Local Control Unit for ITER-India Gyrotron Test Facility (IIGTF)

Ronak Shah, Vipal Rathod, Deepak Mandge, Sharan Dilip, Rajiv Parmar, Amit Yadav, Anjali Sharma and S.L. Rao

Gyrotron Output RF Beam Diagnostics for ITER-India Gyrotron Test Facility (IIGTF)

Anjali Sharma, Vipal Rathod, Ronak Shah, Deepak Mandge, Sharan Dilip, Amit Yadav, Rajiv Parmar and S.L. Rao

Design & Status of EC Main High Voltage Power Supply for ITER & Indian Test program

Darshan Parmar, N P Singh, Thilbault Gassmann, Darbos Caroline, Oda Yasuhisa, Hayashi Kazuo, Aruna Thakae, Amit Patel, Bhavin Raval, Dishang Upadhyay, Hitesh Dhola,

Rasesh Dave, Sandip Gajjar, Vikrant Gupta, Takahashi Koji, S. L. Rao, Mark Henderson, Ujjwal Baruah

Design of C- Band Slot Coupled Profiled Orthomode Transducer (OMT)

Hetshree Shah and K.K. Sood

Instrumentation and Control System architecture of ECRH SST-1

Harshida Patel, Jatin Patel, Dharmesh P, B. K. Shukla, N. Rajanbabu, H. Mistry

***6th Welding Research and Collaboration Colloquium (WRCC), International Institute Welding (IIW), Hyderabad Chapter, Hyderabad, India, 7-9 April 2016***

Evaluation of Weld Joints Properties of 60mm Thick AISI 316L for Fusion Reactor Vacuum Vessel by TIG & EB Welding Processes

Ramesh Kumar Buddu

Taguchi ANOVA for Distortion Analysis of Laser Beam Welding Ansys Model

Suresh Akella, Ramesh K Buddu

Welding Development for ITER Cryostat Base Section

Mitul Patel, Vaibhav Joshi, Rajnikant Prajapati, Girish Gupta, Hemal Desai, and Jibin Jose

ITER-Cryostat Base-section and Lower Cylinder mock-up: Learnings and Implementation

Vaibhav Joshi, Mitul Patel, Rajnikant Prajapati, Girish Gupta, Hemal Desai, and Jibin Jose

***11th International Conference on Tritium Science & Technology (Tritium 2016), Charleston, USA, 17-22 April 2016***

Estimation of Tritium Release from LLCB TBM and its Ancillary Systems and Tritium Management in Different Locations of ITER

Priyanka Brahmabhatt, Amit Sircar, Rudreksh Patel, E. Rajendra Kumar, Sadhana Mohan, Kalyan Bhanja

***CPP-IPR Silver Jubilee Symposium, Assam Don Bosco Institute (DBI), Kharghuli, Guwahati, 21-22 April 2016***

Work Done Towards Beam Instrumentation for Diagnostics of High Energy Proton Beam at Fermilab, USA

Mukti Ranjan Jana

Langmuir probe measurements in a weakly magnetized dusty plasma

D. Kalita, B. Kakati, S. S. Kausik, B.K. Saikia and M. Bandyopadhyay

Activities in CIMPLE-PSI Laboratory, Applied Plasma Research Section CPP-IPR, Sonapur

M. Kakati

Status of the development of CIMPLE-PSI system

N. Aomoa, Trinayan Sarmah and M. Kakati

Plasma assisted synthesis of tokamak-relevant tungsten fine particles and studies of their hydrogen absorption properties

Trinayan Sarmah, N. Aomoa, M.Kakati and G.De. Temmermen

A supersonic plasma beam assisted reactor configuration for controlled synthesis of high temperature nanomaterials with material properties

N. Aomoa, Trinayan Sarmah, Lavita Sarma, and M Kakati

Investigation of  $H^-$  Ion Beam Properties Using Thermal Differential Calorimeter in ROBIN.

Kaushal Pandya, R. Pandey, M.Bandyopadhyay, M.Bhuyan, H.Tyagi, K.Patel, H.Mistri, M.Gauswami, A.Gahlaut, M.Vuppugalla, K.G.Parmar, B.Prajapati, J.Bhagora and A. Chakraborty

A Review on Dust Charging to Fusion Related Research at Dusty Plasma Laboratory, CPP-IPR

S.S. Kausik and B.K. Saikia

Recent experimental studies on IECF device at CPP-IPR

N. Buzarbaruah, D. Borgohain and S.R. Mohanty

**7th International Particle Accelerator Conference (IPAC-2016), BEXCO, Busan Korea, 8-13 May 2016**

Development of a Neutronics Facility using Radio Frequency Quadrupole for Characterization of Fusion Grade Materials  
Renu Bahl, Sumit Kumar, Mridula Mittal, Biswanath Sarkar and Anurag Shyam

**11th ITER Neutronics Meeting, Karlsruhe, Germany 23-27 May 2016**

Neutronics Analysis and Activation Calculation for X-Ray Crystal Spectrometer of ITER,

P.V. Subhash, Gunjan Indauliya, T. Sai Chaitanya, Priti Kanth, Sanjeev Varshney, Siddharth Kumar, K. Raja Krishna, Nirav Bhaliya, Sejal Kamaliya, S. Jakhar, Robin Barnsley, Bernascolle Phillipe, P. Shrishail, and Vinay Kumar

**Summer School Programme, Institute for Plasma Research, Gandhinagar, 31 May 2016**

Vacuum Techniques

S. Sunil

**22nd International Conference on Plasma Surface Interactions in Controlled Fusion Devices, Urbaniana University, Rome, Italy, 29 May 03 June 2016**

On the design, present status and experiments in CPP-IPR Magnetized Plasma Experiment for Plasma Surface Interaction (CIMPLE-PSI)

Mayur Kakati, Ngangom Aomoa, Trinayan Sarmah, J. Ghosh and G. De. Temmerman

**13th International Workshop on Hydrogen Isotopes in Fusion Reactor Materials, Milano, Italy, 06-08 June 2016**

Tungsten microparticles with highly non-equilibrium morphologies for studies on hydrogen absorption in a fusion environment

Mayur Kakati, Ngangom Aomoa, Trinayan Sarmah, J. Ghosh and G. De. Temmerman

**19th World conference on Non Destructive Testing (WCNDT-2016), Munich, Germany, 13-17 June 2016**

Ultrasonic Testing of dissimilar metal joints present in Diverter Plasma Facing Components

Kedar Bhope, Mayur Mehta and S.S.Khirwadkar

**43rd IEEE International Conference on Plasma Science (ICOPS-2016), Banff, Alberta, Canada, 19-23 June 2016**

One dimensional particle-in-cell simulation of relativistic Buneman instability

Roopendra Singh Rajawat

**27th Symposium on Plasma Physics and Technology (SPPT-2016), Czech Technical University in Prague, Czech Republic, 20-23 June 2016**

Study of Arc Plasma Dynamic Behaviour using Combination



of Fast Imaging and Magnetic Diagnostics  
Vidhi Goyal, G. Ravi, P. Bandyopadhyay and S. Banerjee

**30th Meeting of the ITPA Topical Group on Diagnostics, Budker Institute of Nuclear Physics, Novosibirsk, Russia, 21-24 June 2016**

Report of Passive Spectroscopy Specialist Working Group  
Sanjeev Varshney, Changrae Seon, Robin Barnsley

Progress on ITER XRCS- Survey and Edge spectrometer systems

Sanjeev Varshney, Siddharth Kumar, Sapna Mishra, Namita Yadav, P. V. Subhash, Mitul Abhangi, Shivakant Jha, Vinay Kumar, Robin Barnsley, Philippe Bernascolle, Natalia Casal, Julio Guirao, Stefan Simrock, Prabhakant Patil, Vincent Martin, Jean-Marc Drevon, Richard O' Connor, and Michael Walsh

IN-DA Progress on Upper Port #09

Siddharth Kumar, Sanjeev Varshney, Shrishail Padasalagi Shrichand Jakhar, Mitul Abhangi, Shivakant Jha, Vinay Kumar, O'Connor Richard, Giocomin Thibaud, Victor Udintsev

“IN-DA progress on ITER ECE diagnostic system (TL & receiver)”

Hitesh Pandya, Suman Danani, Ravinder Kumar, Shrishail P., Sajal, Shivakant Jha, Vinay Kumar, Victor Udintsev, Natalia Casal

**16th ITPA Topical Group Meeting on Energetic Particles & Workshop on Lost Alpha Diagnostics for ITER, ITER-IO, St Paul-lez-Durance, France, 27-30 June 2016**

A possible detection method for ITER Lost Alpha Diagnostics: Infrared Imaging Video Bolometer

Santosh P. Pandya, Shwetang N. Pandya, Martin Kocan, M. Garcia-munoz and Evgeny Veshchev

**18th International Congress on Plasma Physics (ICPP-2016), Kaohsiung, Taiwan, 27 June- 1 July 2016**

Nonlinear mode-coupling via resonant particles in small amplitude “linear” regime in collisionless plasmas

Debraj Mandal

Experimental observation of Sheath-presheath Instabilities

Vara Prasad Kella, Joydeep Ghosh, Y.C. Saxena, Devendra

Sarma and P.K. Chattopadhyay

Numerical modeling of laser-blow-off plume: lateral interactions of two plumes in presence of background pressure

Sharad K. Yadav, Bhavesh G. Patel, R. K. Singh, Amita Das, Predhiman K. Kaw, and Ajai Kumar

Disruption Characterization in ADITYA Tokamak

R.L. Tanna, Shishir Purohit, M. B. Chowdhuri, J. Ghosh, V.K. Panchal, P.K. Chattopadhyay, Harshita Raj, D. Raju, P.K. Atrey, Y.S. Joisa, C.V.S. Rao, R. Jha and the ADITYA team

Disruption Mitigation Experiments in ADITYA Tokamak

J. Ghosh, R.L. Tanna, Harshita Raj, P.K. Chattopadhyay, P. Dhyani, S.B. Bhatt, K.A. Jadeja, K.M. Patel, C.N. Gupta, M.N. Makwana, K. S. Shah, Chhaya Chavda, V.K. Panchal, N.C. Patel, Shishir Purohit, Y.S. Joisa, C.V.S. Rao, D. Raju, S.V. Kulkarni, B.K. Shukla, Praveenlal E.V., J. Raval, A. Amardas, P.K. Atrey, Umesh Nagora, R. Manchanda, N. Ramaiya, Nilesh, M.B. Chowdhuri, S.K. Jha, R. Jha, A. Sen, Y.C. Saxena, D. Bora

**43rd European Physical Society Conference on Plasma Physics (EPS-2016), Leuven, Belgium, 4-8 July 2016**

The ion resonance instability in a partially neutralized electron cloud that is also colliding elastically with an inert gaseous background: PIC-MCC simulations

Meghraj Sengupta and Rajaraman Ganesh

**IEEE International Power Modulator and High Voltage Conference, San-Francisco, USA, 5-9 July 2016**

Development of 3 MW Dual Output High Voltage Power Supply for ICRH System

A. Patel, H. Dhola, D. Upadhyay, B. Raval, K. Mehta, N. Goswami, N. P. Singh, A. Thakar, D. Parmar, S. Gajjar, R. Dave, V. Gupta, U.K. Baruah, S. Athaullah, Y. Dileep, A. Rajakiran, D.H. Rathod, N. Appa Rao, K. Mahadev

**READIT-2016 Pre-Conference Meeting of DAE Units, IGCAR, Kalpakkam, 12 July 2016**

IPR Library Resources

Saroj Das

**IEA Workshop on Disruptions, Princeton Plasma Physics Laboratory (PPPL), USA 20-22 July 2016**

TSC Modeling of Disruptions and VDEs in DIII-D and CMOD

Indranil Bandyopadhyay

**5th PSSI-Plasma Scholars Colloquium (PSC), Ravenshaw University, Cuttack, 27-28 August 2016**

Measurement of Magnetic Fluctuation in LVPD: A Comparison of Results using Numerical and Inline Integrator Techniques

Prabhakar Srivastav, L. M. Awasthi, A. K. Sanyasi, P. K. Srivastava, and R. Sugandhi

Emission of fusion neutron from an inertial electrostatic confinement fusion device

N. Buzarbaruah, D. Borgahain and S.R. Mohanty

**29th Symposium on Fusion Technology (SOFT-2016), Prague, Czech Republic, 5-9 September 2016**

Initial Operation of 3MW Dual Output High Voltage Power supply with IC RF System

A. Patel, H. Dhola, D. Upadhyay, K. Mehta, N. Goswami, B. Raval, N. P. Singh, A. Thakar, D. Parmar, S. Gajjar, R. Dave, V. Gupta, S. Varma, K. Rajnish, R. Singh, R. G. Trivedi, D. Soni, A. Mukherjee, U. K. Baruah

Comparative Study between Code and Analytical Stress Intensification Factor in ITER Cooling System Piping

Aditya Singh, M. Jadhav, K. S. Bhatt, L. K. Sharma, D. K. Gupta, A. G. Ajith Kumar

Detailed Design of ITER CCWS, CHWS and HRS: Challenges Experienced and Their Solutions

Ajith Kumar, Dinesh Gupta, Nirav Patel, Mahesh Jadhav, Hiren Patel, Jinendra Dangi, Gumansinh Gohil, Lalit Sharma, Aditya Singh, Rakesh Ranjan, Mohit Kumar, Liliana Teodoros, Ployhar Steve, Dell'orco Giovanni

Recent Results on ECR Assisted Plasma Start-Up, Current Drive and Discharge Cleaning in SST-1

Braj Shukla

The West Plasma Facing Components Protection

Jean-Marcel Traverre, Sutapa Ranjan, Philippe Moreau, Colette Balorin, Jerome Bucalossi, Vishnu Chaudhari, Yann Corre, Mehdi Firdaouss, Jonathan Gaspar, Hemant Joshi, Michel Jouve, Victor Moncada, Eric Nardon, Remy Nouaillietas, Tran-Thanh Ngo, Nathalie Ravenel, Benjamin Santraine, West Team

Measurements and Controls Implementation for the West Project

Philippe Moreau, Jerome Bucalossi, Xavier Courtois, Christophe Gil, Philippe Lotte, Eric Nardon, Remy Nouaillietas, Nathalie Ravenel, Jean-Marcel Traverre, Olivier Meyer, Marc Missirlian, Frank Samaille, Jacqueline Signoret, Sylvain Bremond, Raju Daniel, Manisha Bhandarkar, Chhaya Chavda, Ritesh Sugandhi, Vishnu Chaudhari, Jigneshkumar Soni, Jasraj Dhongde, Sunil Belsare, Aveg Kumar, Praveena Kumari, Imran Mansuri, Harish Masand, Kirit Patel, Sutapa Ranjan, Manika Sharma, Hemant Joshi, Miteshkumar Patel, Christopher Rapson, Gerhard Raupp, Wolfgang Treuterrer, Annette Spring, Andreas Werner, Marc Lewerentz, West Team, Heique Laqua

Design and Implementation of Electromagnetic Diagnostic Electronics in SST-1 Tokamak

Praveenlal Edappala, Chandresh Hansalia, Rachana Rajpal, Hitesh Mandaliya, Vismay Raulji, Sameer Kumar, Raju Daniel

Conceptual Design Study of Toroidal Field Magnet System of SST-2 Fusion Reactor

Aashoo Sharma, S. Dutta, P. Dutta, R. Srinivasan, S. Pradhan, U. Prasad, V. Menon, C. Danani

Conceptual Study on Selection of Quench Detection System for CS Magnet of SST-1

Yohan Khristi, Subrata Pradhan, Moni Banaudha

Ultrasonic Testing of Different Shapes of Support Rib and Lower Bracket Assembly Weld Joints

Yatinkumar Sarvaiya, Haresh Pathak, Rahul Laad, C. H. Choi, Jigar Raval

Development of Prototype Elements for Beamline Components for ITER DNB and Indian Test Facility

Hitesh Kumar K. Patel, Chandramouli Rotti, Nirmal Panda, Nitin Kanoongo, K. Balasubramaniam, Arun Chakraborty

Manufacturing Technology Development for an 'Angled' Accelerator Grid Segment for Diagnostic Neutral Beam (DNB) Source

Jaydeepkumar Joshi, Arunkumar Chakraborty, Chandramouli Rotti, Mainak Bandyopadhyay, Christian Eckardt, Eberhard Pfaff, Jorg Schafer, Aron Metz, Dusan Stupar, Wischet Yannic

Helium Cooling Systems for Indian LLCB TBM

Brijesh Kumar Yadav



Rotating Tritium Target for Intense 14-MeV Neutron Source  
Sudhirsinh Vala, Dhaval Rajyaguru, Mitul Abhangi, Ratnesh Kumar, Anurag Shyam, Biswanath Sarkar

SST-1 Up-Gradation Update & Recent Experiments in SST-1  
Subrata Pradhan, Ziauddin Khan, Vipul L. Tanna, Dilip Raval, Upendra Prasad, Harish Masand, Aveg Kumar, Kiritkumar B. Patel, Manisha K. Bhandarkar, Jasraj R. Dhongde, Braj Kishor Shukla, Imran A. Mansuri, Yohan S. Khristi, Yuvakiran Paravastu, Chet Narayan Gupta, Dinesh Kumar Sharma, Kalpeshkumar R. Dhanani, Pratibha Semwal, Siju George, Subrata Jana, Pradip N. Panchal, Rohitkumar N. Panchal, Rakeshkumar J Patel, Hitesh Kumar Gulati, Kirti Mahajan, Mohammad Shoaib Khan, Prashant L. Thankey, Firozkhan S. Pathan, Azadsinh R. Makwana, Gaurang I. Mahsuriya, Pradeep K. Chauhan, A. Arun Prakash, Murtuza M. Vora, Akhilesh Singh, Dashrath P. Sonara, Pankaj Varmora, G. Srikanth, Dickens R. Christian, Atul Garg, Arun G. Panchal, Nitin Bairagi, Manika Sharma, Gattu R. Babu, Prosenjit Santra, Tejas J. Parekh, Hitesh S. Patel, Prabal Biswas, Snehal P. Jayaswal, Tusharkumar Y. Raval, Hitesh H. Chudasma, Atish L Sharma, Amit Ojha, Bhadrash R. Praghi, Moni Banaudha, Ketan G. Patel, Hiren D. Nimavat, Pankil R. Shah, J. C. Patel, Rajiv Sharma, A. Varadharajulu, Ranjana Manchanda, P. K. Atrey, S. K. Pathak, Y. Sankar Joisa, Kumudni Asudani, Manoj Kumar, Debashis Ghosh, Bhumi Chaudhari, Amita Das, D. Bora, SST-1 Team

Demonstration of Synchronous Control of EC TL Switch and Gyrotron for ITER EC System  
Yasuhisa Oda, Katsumi Ohshima, Kazuo Hayashi, Ryosuka Ikeda, Koji Takahashi, Keishi Sakamoto, Franco Gandini, Dharmesh Purohit, Izuru Yonekawa, Caroline Darbos, Mark Henderson

Integration of Epics Based Monitoring for ION Cyclotron high Voltage Power Supply  
Hiteshkumar Dhola, Darshit Pandya, Rasesh Dave, Aruna Thakar, Amitkumar Patel, Narindarpal Singh, Ujjwal Baruah

Data Acquisition System for LN<sub>2</sub> Cool Down Experiment for 6 Nos. of Cryogenics Pumps  
Karishma Qureshi, Paresh J. Patel, Chodimella Chakrapani, Sanjay L. Parmar, Laxmikant K. Bansal, Bhargav Pandya, Dipal Thakkar, C. B. Sumod, Laxminarayan Gupta, Vijay Vadher, Bhargav Choksi, Nilesh Contractor, Sanjeev Sharma, B. V. V. S. N. N. P. Sridhar, Siddibomma Rambabu, Punjapyu Bharathi, Mukti Ranjan Jana, Vattipelle Prahlad, Ujjwal Kumar Baruah

ADITYA Upgrade Vacuum Vessel: Design, Construction, Testing, Installation and Operation  
Kumarpalsinh Jadeja, Shailesh Bhatt, Joydeep Ghosh, Kaushal Patel, Kulav Rathod, Vishnu Prajapati, Rakesh Tanna, Yogesh Saxena, Dhiraj Bora

Development and Characterization of Thick Copper Coating by Laser Cladding for in Vessel Components  
Ramesh Buddu, Shamsuddin Shaikh, P. M. Raole, N. Chauhan, Harshad Natu, Harpreet Singh

Fault Energy Dump & Repeated Breakdown Validations of HVPS Commissioned for Negative ION Source-Robin  
Mahesh Vuppugalla, Agrajit Gahlaut, Arun Chakraborty, Ratnakar Yadav, Kanubhai Parmar, Bhavesh Prajapati, Gourab Bansal, Jignesh Soni, Mainak Bandyopadhyay, Kaushal Pandya, Varunesh Kumar

Progress in Development of Pellet Injector Technology in India  
Ranjana Gangradey, Jyoti Shankar Mishra, Samiran Mukherjee, Paresh Panchal, Pratik Nayak, Jyoti Agarwal

Design of Highpower RF Amplifier for 3MW/CW transmission Line Test Rig  
Raghuraj Singh, Aparajita Mukherjee, Ajesh P., Akhil Jha, J. V. S. Hari, R. G. Trivedi, Rajnish Kumar, Gajendra Suthar, Rohit Anand

Development of Wideband Solid State Power Amplifier for ICH & CD RF Source  
Manojkumar Patel, Akhil Jha, Harikrishna J. V. S, Rajnish Kumar, Rajesh Trivedi, Aparajita Mukherjee

Development of Cryoadsorption Cryopump & its Related Auxiliary Technologies in India  
Ranjana Gangradey, Samiran Mukherjee, Jyoti Agrawal, Jyotishankar Mishra, Paresh Panchal, Pratik Nayak, S. Kasthuriangan, S. Udgata, V. S. Tripathi

Implementation of Synchronous Reference Frame Theory based Shunt Active Power Filter using DSP Controller  
Chandra Kishor Gupta

Design and Development of High Pressure High Temperature Water Circulation System for HHFTF  
Rajamannar Swamy Kidambi, Samir Khirwadkar, Sunil Belsare, Sudhir Tripathi, Tushar Patel

Progress Development of Medium Size Dome & Reflector Plate for ITER like Tokamak Application

Premjit K. Singh, S. Khirwadkar, Deepu Krishnan, Kedar Bhope, Vinay Menon, Sunil Belsare, Nikunj Patel, Prakash Mokaria, Mayur Mehta

Development of a Prototype Work-Cell for Validation of ITER Remote Handling Control System Standards

Naveen Rastogi, Vamshi Krishna, Pramit Dutta, Manoah Stephen, Krishan Gotewal, Hamilton Kumar, David, J. K. Mukherjee

Design Status of Remote Handling Compatibility of ITER DNB Components

Roopesh Gangadharan Nair

***International Conference on Ion Beams in Materials Engineering and Characterizations (IBMEC 2016), Inter-University Accelerator Centre (IUAC), New Delhi, 28 September -1 October 2016***

In-Situ RBS study of the sticking behaviour of silver atoms on low energy ion produced ripple patterned SiO<sub>2</sub> substrate  
Mukesh Ranjan

***69th Annual Gaseous Electronics Conference (GEC), Ruhr University, Bochum, Germany, 10-14 October 2016***

Effect of Driving frequency on the electron-sheath interaction and energy distribution function in low pressure capacitively coupled plasmas

Sarveshwar Sharma, Nishant Sirse, Predhiman Kaw, Miles Turner, Albert R. Ellingboe

Effect of weak static magnetic field on electron and ion dynamics in low pressure capacitive discharges

Sarveshwar Sharma, Igor Kaganovich, Predhiman Kaw, Sanjay Mishra, Alexander Khrabrov, Dmytro Sydorenko

***26th IAEA Fusion Energy Conference, Kyoto, Japan, 17-22 October 2016***

Overview of SST-1 Upgrade & Recent Experiments in SST-1  
S. Pradhan, Z. Khan, V. L. Tanna, U. Prasad, Y. Paravastu, D. C. Raval, H. Masand, A. Kumar, J. R. Dhongde, K. B. Patel, M. K. Bhandarkar, B. K. Shukla, S. Jana, D. Ghosh, H. S. Patel, T. J. Parekh, I. A. Mansuri, K. R. Dhanani, A. Varadharajulu, Y. S. Khristi, P. Biswas, C. N. Gupta, S. George, P. Semwal, D. K. Sharma, H. K. Gulati, K. Mahajan, B. R. Praghi, M.

Banaudha, A. R. Makwana, H. H. Chudasma, M. Kumar, R. Manchanda, Y. S. Joisa, K. Asudani, S. N. Pandya, S. K. Pathak, P. J. Patel, P. Santra, F. S. Pathan, P. K. Chauhan, M. S. Khan, P. L. Thankey, A. Prakash A, P. N. Panchal, R. N. Panchal, R. J. Patel, G. I. Mahsuria, D. P. Sonara, K. M. Patel, S. P. Jayaswal, M. Sharma, J. C. Patel, P. Varmora, G. L. N. Srikanth, D. R. Christian, A. Garg, N. Bairagi, G. R. Babu, A. G. Panchal, M. M. Vora, A. K. Singh, R. Sharma, H. D. Nimavat, P. Shah, T. Y. Raval, A. L. Sharma, A. Ojha, S. Kumar, N. K. Ramaiya, V. Siju, M. V. Gopalakrishna, A. Kumar, P. K. Sharma, P. K. Atrey, S. V. Kulkarni, K. K. Ambulkar, P. R. Parmar, A. L. Thakur, J. V. Raval, S. Purohit, P. K. Mishra, A. N. Adhiya, U. C. Nagora, J. Thomas, V. K. Chaudhari, K. G. Patel, S. Dalakoti, C. G. Virani, S. Gupta, A. Kumar, B. Chaudhari, R. Kaur, R. Srinivasan, A. N. Sharma, K. J. Doshi, D. Raju, D. H. Kanabar, R. Jha, A. Das, and D. Bora

Overview of Recent Experimental Results from ADITYA Tokamak

R. Tanna, J. Ghosh, P. K. Chattopadhyay, H. Raj, S. Patel, C. Gupta, P. Dhyani, K. A. Jadeja, K. M. Patel, S. B. Bhatt, V. K. Panchal, N. C. Patel, C. Chavda, E. V. Praveenlal, K. S. Shah, M. N. Makwana, S. K. Jha, M. V. Gopalakrishna, K. Tahiliani, D. Sangwan, D. Raju, U. C. Nagora, S. K. Pathak, P. K. Atrey, S. Purohit, Y. S. Joisa, J. V. Raval, C. V. S. Rao, M. B. Chowdhuri, S. Banerjee, J. Thomas, N. K. Ramaiya, R. Manchanda, A. Kumar, P. K. Sharma, S. V. Kulkarni, K. Sathyanarayana, B. K. Shukla, A. Das, R. Jha, Y. C. Saxena, A. Sen, P. K. Kaw, and D. Bora

Energy Exchange Dynamics across L-H Transitions in NSTX  
A. Diallo, S. Banerjee, S. Zweben, and T. Stoltzfus-Dueck

Observation of Large Filaments during the Disruptive Phase of ADITYA Tokamak Plasma

S. Banerjee, N. K. Bisai, D. Chandra, P. Dhyani, R. Manchanda, M. B. Chowdhuri, N. K. Ramaiya, N. Parmar, J. Ghosh, R. Tanna, P. K. Chattopadhyay, D. Raju, P. K. Atrey, Y. Shankar Joisa, A. Sen, and P. K. Kaw

Plasma Startup Studies and Electromagnetic Field Computation for SST-1 Tokamak

S. Jana, D. Ghosh, S. Pradhan, and D. C. Raval

MHD Phenomena and Disruption Characteristics in SST-1 Early Plasma

J. R. Dhongde, M. K. Bhandarkar, and S. Pradhan



Observation and Study of Lock Mode Characteristics in SST-1 Plasma

M. K. Bhandarkar, J. R. Dhongde, and S. Pradhan

Low Density Plasma Regimes in SST-1 with and without Suprathermal Electrons

K. Patel, and S. Pradhan

Plasma Facing Components Technologies in SST-1

D. C. Raval, Z. Khan, Y. Paravastu, K. R. Dhanani, P. Semwal, S. George, A. Prakash A, G. R. Babu, M. S. Khan, P. L. Thankey, F. S. Pathan, and S. Pradhan

Experimental Observations and Modelling of Poloidal Asymmetries in Radiation Profiles during N<sub>2</sub> Seeding Compared with Ne Seeding in LHD

B. Peterson, G. Kawamura, K. Mukai, S. Dai, S. Masuzaki, T. Akiyama, M. Kobayashi, H. Tanaka, S. N. Pandya, R. Sano, M. Goto, G. Motojima, R. Sakamoto, N. Ohno<sup>4</sup>, T. Morisaki, and J. Miyazawa

Role of Neutral Gas in Scrape-Off Layer of Tokamak Plasmas

N. K. Bisai, and P. K. Kaw

Excitation of Zonal Flows and their Impact on Dynamics of Edge Pedestal Collapse

H. Jhang, H. H. Kaang, S. S. Kim, T. S. Hahm, R. Singh, and T. Rhee

Plasma Disruption and VDE Modelling in Support of ITER

I. Bandyopadhyay, A. K. Singh, N. W. Eidietis, D. A. Humphreys, R. S. Granetz, G. Pautasso, A. Isayama, and S. C. Jardin

Nonlinear Simulation of ELM Dynamics in the Presence of RMPs and Pellet Injection

D. Chandra, A. Thyagaraja, A. Sen, and P. K. Kaw

Progress in the ITER Integrated Modelling Programme and the use and Validation of IMAS within the ITER Members

S. D. Pinches, R. Akers, R. Andre, T. Aniel, I. Bandyopadhyay, V. Basiuk, E. A. Belli, X. Bonnin, J. Candy, A. K. Chattopadhyay, W. Dekeyser, L. T. H. van Dellen, B. Faugeras, A. Fukuyama, M. Gorelenkova, M. Hosokawa, P. Huynh, S. Ide, F. Imbeaux, H. Jhang, I. Johnson, T. Johnson, L. Jung, R. R. Khayrutdinov, S. H. Kim, S. Kononov, L. Kos, L. L. Lao, Y. Liu, L. LoDestro, V. E. Lukash, I. Lupelli, S. Medvedev, O. Menghini, W. H. Meyer, D. Muir, O. Naito, E. Nardon, F. Poli, A. Polevoi, O. Sauter, M. B. Schneider, A.

K. Singh, P. B. Snyder, G. M. Staebler, P. Strand, M. Suzuki, S. Wiesen, and D. Zhao

Effect of Magnetic Shear and Equilibrium Flows on Collisionless Microtearing and Mixed Parity Modes in Hot Tokamak Plasmas

D. Verma, A. K. Swamy, R. Ganesh, S. Brunner, and L. Villard

Residual Stress and Momentum Transport in Electromagnetic ITG Turbulence

H. H. Kaang, S. S. Kim, H. Jhang, R. Singh, and J. Kim

Investigation of Neutral Particle Dynamics in ADITYA Tokamak Plasma with DEGAS2 Code

R. Dey, J. Ghosh, M. B. Chowdhuri, P. N. Maya, R. Manchanda, S. Banerjee, N. K. Ramaiya, and D. P. Stotler

Progress in High Power Test of R&D Source for ITER ICRF System

A. Mukherjee, R. Trivedi, R. Singh, R. Kumar, D. Soni, S. Verma, G. Suthar, A. Jha, P. A. Subbarao, M. Patel, R. Anand, R. Agarwal, K. Mohan, H. Jayanthi, H. Machchhar, P. Vasava, H. Patel, H. Dalicha, U. Baruah, A. Patel, N. Singh, N. S. Goswani, K. R. Mehta, D. V. Upadhyay, H. Dhola, F. Kazarian, B. Beaumont, A. Agharbi, A. Boussaton, P. Cacheux, A. Debbiche, M. Grézaud, N. Péneau, F. Pompon, C. Robert, M. Savoie, and S. Sierra

Progresses on WEST Platform Construction towards First Plasmas

J. Bucalossi, M. Missirlian, P. Moreau, F. Samaille, E. Tsitrone, T. Alarcon, S. Antusch, M.-H. Aumeunier, S. Balme, T. Batal, J. M. Bernard, F. Bouquy, C. Bourdelle, S. Bremond, S. Brezinsek, C. Brun, H. Bufferand, Y. Camenen, B. Cantone, M. Chantant, M. Chernyshova, G. Ciraolo, G. Colledani, J. Colnel, E. Corbel, Y. Corre, X. Courtois, R. Daniel, T. Daudel, R. Dejarnac, E. Delmas, L. Delpech, C. Desgranges, L. Doceul, D. Douai, H. Dougnac, A. Ekedahl, D. Elbeze, A. Escarguel, F. Escourbiac, K. Ezato, F. Faïsse, C. Fenzi, F. Ferlay, M. Firdaouss, J. L. Gardarein, L. Gargiulo, J. Gaspar, P. Gavila, S. Gazzotti, J. C. Giacalone, C. Gil, E. Grigore, D. Guilhem, J. P. Gunn, A. Hakola, J. C. Hatchressian, W. Helou, P. Hennequin, C. Hernandez, M. Houry, M. Jouve, C. Klepper, G. Laffont, P. Languille, S. Larroque, Q. Li, J. Linke, M. Lipa, P. Lotte, G.-N. Luo, Y. Marandet, C. Martin, A. Martinez, D. Mazon, O. Meyer, P. Mollard, E. Nardon, R. Nouailletas, H. K. Park, J. Y. Pascal, B. Pégourié, R. A. Pitts, C. Pocheau, S. Poli, N. Ravenel,

B. Riccardi, M. Richou, M. Rieth, H. Roche, C. Ruset, F. Sabathier, A. Saille, F. Saint-Laurent, B. Santraine, Y. Seki, D. Sestak, J. Signoret, B. Soler, S. Suzuki, D. Thouvenin, L. Toulouse, J.-M. Travere, W. Treutterer, S. Vartanian, J.-M. Verger, L. Vermare, N. Vignal, Y. Wang, Y. Wang, A. Werner, Q. Yang, B. Zago, W. Zhao, and G.-W. Zhong

Development of Sensors for High-Temperature High-Pressure Liquid Pb/Pb-16Li Applications

A. Saraswat, S. Sahu, T. S. Rao, A. Prajapati, S. Verma, S. Gupta, M. Kumar, R. Bhattacharyay, and P. Das

Electro-Mechanical Design and Experimental Validation of Post Insulators for Beam Source for ITER Diagnostic Neutral Beam

V. N. Muvvala, J. Joshi, S. Shah, D. Parmar, C. Rotti, M. Bandyopadhyay, and A. K. Chakraborty

Concept Design of the Heavy Duty Multipurpose Deployer for ITER

K. K. Gotewal, N. Rastogi, S. M. Manoah, P. Dutta, and C.-H. Choi

The ITER Neutral Beam Test Facility toward SPIDER Operation

V. Toigo, D. Boilson, T. Bonicelli, A. K. Chakraborty, and U. Fantz

Manufacturing and Commissioning of Large Size UHV Class Vacuum Vessel for Indian Test Facility (INTF) for Neutral Beams

J. Joshi, A. Yadav, K. Joshi, D. Singh, H. Patel, S. Ulahannan, V. Abbavaram, G. Hebbar, M. Alaparathi, M. Khan, C. Rotti, M. Bandyopadhyay, and A. K. Chakraborty

Upgrade of ADITYA Tokamak with Limiter Configuration to ADITYA Upgrade Tokamak with Divertor Configuration

J. Ghosh, R. Tanna, S. B. Bhatt, P. K. Chattopadhyay, K. Sathyanarayana, C. Chavda, C. Gupta, K. A. Jadeja, K. Patel, V. K. Panchal, V. Patel, K. Rathod, S. Patel, S. Jaiswal, P. K. Chauhan, V. Ranjan, R. Kumar, H. Raj, K. Kumari, D. Sadharakiya, M. Kalal, D. Varia, R. N. Panchal, K. Acharya, N. Patel, K. Chaudhary, M. N. Makwana, K. S. Shah, D. Raju, R. Srinivasan, D. K. Sharma, S. Dutta, B. Doshi, M. Gupta, U. Baruah, A. Varadharajulu, A. Das, Y. Saxena, D. Bora, R. Pal, S. Saha, A. Apte, and D. Patel

Zero D and 1.5D Transport Analysis of SST-2

V. Menon, R. Daniel, R. Srinivasan, U. Prasad, C. Danani, A.

L. Sharma, J. Agarwal, P. Dutta, N. Rastogi, R. Srivastava, S. Dutta, M. Himabindu, D. K. Sharma, K. K. Gotewal, A. K. Chakraborty, S. Khirwadkar, R. Kumar, S. Pradhan, S. P. Deshpande, and P. K. Kaw

Progress towards Achieving Large Pumping Speed for Exhaust from Fusion Grade Machines

R. Gangradey, S. Mukherjee, J. Agarwal, J. Mishra, P. N. Panchal, P. Nayak, S. Kasthuriengan, S. Udgata, and V. S. Tripathi

Nuclear Design Analyses of SST-2

C. Danani, K. Chandrasekhar, B. J. Saikia, A. L. Sharma, D. K. Sharma, M. Himabindu, J. Agrawal, K. K. Gotewal, S. M. Manoah, N. Rastogi, P. Dutta, S. Dutta, U. Prasad, V. Menon, A. K. Chakraborty, S. Khirwadkar, R. Ellappan, S. Pradhan, S. P. Deshpande, and P. K. Kaw

Overview of Indian LLCB TBM Programme and Status of R&D Activities

R. Bhattacharyay, A. Saraswat

Techno-Economic Aspects of High Current Leads for Fusion Devices

V. L. Tanna, S. Pradhan

India's Pellet Fueling Programme

J. Mishra, S. Mukherjee, R. Gangradey, J. Agarwal, P. N. Panchal, and P. Nayak

Design of Charge Exchange Recombination Spectroscopy (CXRS) on SST-1 Tokamak

M. B. Chowdhuri, G. Shukla, K. S. Shah, J. Ghosh, K. H. Burrell, B. A. Grierson, V. Prahlad, S. Sharma, P. Bharthi, R. Manchanda, S. Banerjee, and N. K. Ramaiya

Design and Analysis of SST-2 Vacuum Vessel

S. M. Manoah, P. Dutta, N. Rastogi, K. K. Gotewal, R. Srinivasan, C. Danani, V. Menon, A. L. Sharma, U. Prasad, M. Himabindu, D. K. Sharma, J. Agarwal, S. Dutta, R. Gangradey, R. Ellappan, S. Khirwadkar, A. K. Chakraborty, S. Pradhan, D. Shishir, and P. K. Kaw

***58th Annual Meeting of the APS Division of Plasma Physics, San Jose, California, 31 October - 4 November 2016***

Co-existence of Kelvin Helmholtz and Drift wave Instabilities in IMPED

Sayak Bose, PK Chattopadhyay, J Ghosh, YC Saxena



Flow past an obstacle immersed in a Yukawa liquid: An atomistic study

Harish Charan and Rajaraman Ganesh

**31st ITPA-Diagnostics Meeting, ITER Organization, France, 7-10 November 2016**

Report of Passive spectroscopy Specialist Working Group  
Sanjeev Varshney, Changrae Seon, Robin Barnsley

Progress on ITER XRCS-Survey and XRCS-Edge Spectrometer Systems

Sanjeev Varshney, Siddharth Kumar, Sapna Mishra, Shivakant Jha, Chirag Khairnar, Ravi Patel, Dharmesh Bhatia, Sejal Kamaliya, P. V. Subhash, Mitul Abhangi, Vinay Kumar, Robin Barnsley, Philippe Bernascolle, Julio Guirao, Vincent Martin, Stefan Simrock, Jean-Marc Drevon, Richard O' Connor, Michael Walsh

IN-DA Progress on Upper Port #09

Siddharth Kumar, Sanjeev Varshney, Shrishail Padasalagi Shrichand Jakhar, Mitul A, Shivakant Jha, Vinay Kumar, O'Connor Richard, Julio Guirao, Victor Udintsev

IN-DA progress on ITER ECE diagnostic system (TL & receiver)

Suman Danani, Ravinder Kumar, Sajal Thomas, Shivakant Jha, Rachana Rajpal, Siddharth, Shrishail P, Hitesh Pandya, Vinay Kumar, Victor Udintsev

**10th Biennial National Conference of the Physics Academy of North East, St. Anthony's College, Shillong, India, 10-12 November 2016**

Charging of Dust Grains in Low-Pressure Filament Discharge Plasma

S.S. Kausik, B. Kakati, D. Kalita, B.K. Saikia and M. Bandyopadhyay

Shielding analyses for a portable neutron source

D. Borgohain, N. Buzarbaruah and S.R. Mohanty

**India International Conference on Power Electronics (IICPE), Thapar University, Patiala, Punjab, 18 November 2016**

An Accurate Electrical Model for Atmospheric Pressure DBD Plasma in Air with Experimental Validation

Vishal Jain, R. Srinivasan, V. Agarwal

**69th Annual American Physical Society: Division of Fluid Dynamics Meeting, Portland, USA, 20-22 November 2016**

Unstable Shear Flows in Two-Dimensional Strongly Correlated Liquids - A Hydrodynamic and Molecular Dynamics Study

Akanksha Gupta, Rajaraman Ganesh and Ashwin Joy

**33rd DAE Safety & Occupational Health Professionals Meet, Institute for Plasma Research, Gandhinagar, 23-25 November 2016**

Experience with Cryogenics Safety, Problems and Solutions  
Rajiv Sharma, V.L. Tanna

Advanced Fire Prevention Techniques for ITER-INDIA Laboratory Building, IPR

D.V. Modi, D. Chenna Reddy

High Voltage Discharge Switch for operational safety of Neutral Beam High Voltage Power Supply System

L.N. Gupta, Paresh Patel, C.B. Sumod, Dipal Thakkar, N.P. Singh, Ujjwal Baruah

Safety Legislation and Regulations for Electron Beam Welding

Gautam R. Vadolia, K. P. Singh, Devendra Modi

Safety Management and Safe Handling of Materials in Lithium Ceramic Development Process

Mayank Makwana, P. Patel, M. Panchal, B. Riscob, A. Srivastava, P. Chaudhuri

Safety and Shielding Management for Pulse Power Lab at IPR.

Shweta Upadhyay, Akash Faldu, Rahul Koshti, and Rajesh Kumar

**Power India International Conference (PIICON), Lalgargh Palace, Bikaner, Rajasthan, 26 November 2016**

Design and Simulation of Feedback System to Generate Plasma Arc in Current Source Mode.

Vishal Jain, S K Nema, V. Agarwal

**13th Asia Pacific Physics Conference and 22nd Australian Institute of Physics Congress (APPC-AIP-13), Brisbane, Australia, 4-8 December 2016**

Sputtering yield shape profile under stationary plasma thruster conditions  
Mukesh Ranjan

***18th Asian Conference on Electrical Discharge (ACED 2016), IIT Madras, Chennai, 8-10 December 2016***

Plasma jet using atmospheric pressure dielectric barrier discharge  
C. Patil, R. Rane, A. Vaid, A. Sanghariyat, S. Mukherjee

***6th International and 43rd National Conference on Fluid Mechanics and Fluid Power, Motilal Nehru National Institute of Technology (MNNIT), Allahabad, 15-17 December 2016***

Helium Flow Dynamics and Heat Transfer in a Cable in Conduit Conductor of Superconducting Magnets: A review  
Hitensinh Vaghela, Vikas Lakhera, Biswanath Sarkar

***National Welding Seminar (NWS 2016), Science City, Kolkata, 15-17 December 2016***

Repairing and welding experience of LN<sub>2</sub> cryogenic transfer line of 80 K distribution system of SST-1  
Rajiv Sharma, V. L. Tanna, Hiren Nimawat, Gaurav Purwar

***International Conference on Advanced Computing and Intelligent Engineering, C. V. Raman College of Engineering, Bhubaneswar, India, 21-23 December 2016***

Integration of Python based MDSPLUS Interface for ICRH DAC Software  
Ramesh Joshi, Swanand Kulkarni & S.V. Kulkarni

***21st National Conference in Atomic and Molecular Physics (NCAMP-2017), Physical Research Laboratory, Ahmedabad, Gujarat, India, 3-6 January 2017***

Estimation of Cesium fraction in ROBIN Ion Source using Spectral Analysis of Line Emissions and the Correlation with the Extracted Current Density.  
Dass Sudhir Kumar, Mainak Bandyoadhyay, Manas Bhuyan, Kaushal Pandya, Ratnakar Yadav, Himanshu Tyagi, Jignesh Bhagora, Kartik Patel, Agrajit Gahlaut, Mahesh Vuppugallaa, K. G. Parmar, Hiren Mistri, Arun Chakraborty

Studies of Aditya tokamak plasma using visible spectroscopic diagnostics

M. B Chowdhuri, J. Ghosh, R. Dey, R. Manchanda, N. Yadava, S. Banerjee, N. Nimavat and Aditya Team

Role of atomic and molecular processes in H $\alpha$  emission of Aditya tokamak

Ritu Dey, Joydeep Ghosh, M. B. Chowdhuri, R. Manchanda, S. Banerjee, N. Nimavat, N. Yadava and ADITYA Team

Semi-implicit method for solving the radial impurity transport equation and comparison with impurity transport code STRAHL

Amrita Bhattacharya, Joydeep Ghosh, M. B. Chowdhuri, Prabhat Munshi

Simulation of Hydrogen-alpha (H $\alpha$ ) spectral line shape emitting from the edge region of Aditya Tokamak

Nandini Yadava, Joydeep Ghosh, M. B. Chowdhuri, R. Manchanda, S. Banerjee, Ritu Dey, N. Nimavat and D. Tripathi

Simulation of Spectral Distribution of radiation emission in Aditya tokamak and its comparison with experimental measurements

Kumudni Tahiliani, M. B. Chowdhuri, R. Jha, M.V. Gopalakrishna, Sameer Kumar, D. Raju, U. C. Nagora, P.K. Atrey, J. Raval, Y. Shankar Joisa, R.L. Tanna, J. Ghosh, Ajai Kumar and Aditya Team

Spectroscopic measurements of gas temperature in the neutralizers of DIII-D neutral beam injectors

S. K. Sharma, B. Choksi, B. Crowley, J. Rauch and J. T. Scoville

***International Conference on Emerging Trends in Nanomaterial's Science & Technology (ICETNMST - 2017), National Institute of Technology (NIT) Nagaland, Chumukedima, Nagaland, India, 4-6 January 2017***

Influence of Capping Agent on the Magnetic Properties of Copper Ferrite Nanoparticles

Anurag Kashyap, Seikh Mustafa Radiul, Lavita Sarma, Mayur Kakati, A. Srinivasan and Sidananda Sarma

***International Conference on Advances in Nanotechnology (iCAN-17), Assam Don Bosco University, Guwahati, Assam, India, 9-13 January 2017***

Studies of magnetic properties of Iron oxide nanoparticles prepared by Green chemical method and supersonic nozzle

expansion plasma method

Lavita Sarma, Trinayan Sarmah, N.Aomoa, Sidananda Sarma, Mayur Kakati

Tokamak relevant tungsten dust particles synthesized by plasma assisted method and studies of their hydrogen absorption properties

Trinayan Sarmah, N. Aomoa, Sanjiv Kuumar and M. Kakati

Studies on controlled synthesis of superparamagnetic carbon encapsulated magnetic nanoparticles (CEMN) by plasma expansion technique

N. Aomoa, Lavita Sarma, Trinayan Sarmah, Sidananda Sarma and M. Kakati,

***International Conference on Magnetic Materials and Applications (ICMAGMA-2017), Hyderabad, Telangana, 1-3 February 2017***

Effect of heat treatment on the magnetic properties of copper ferrite nanoparticles

Lavita Sarma, M. Kakati, K. K. Singh, A. Srinivasan and Sidananda Sarma

***4th International Conference on Nano-structured Materials and Nano-composites (ICNM 2017), Mahatma Gandhi University, Kottayam, Kerala, India, 10-12 February 2017***

Preparation, Characterization and Oxidation Behaviour of Silicon Oxide Based Inter-face Layer Coating on Carbon Fiber for C<sub>f</sub>/SiC Composites

C. Jariwala, Kundan Kumar and R. Pillai

***2nd International Conference on Advances on Material Science (ICMS-17), Tripura University, Agartala, Tripura, 16-18 February 2017***

Study of chemical, structural and morphological properties of tungsten nanopowder produced in a DC thermal plasma reactor from an oxide feedstock

Trinayan Sarmah, N. Aomoa, Sidananda Sarma, D.N. Srivastava, U. Deshpande and M. Kakati

Magnetized Plasma Experiment for Plasma Material Interaction (CIMPLE- PMI) device, its development and experiments

N. Aomoa, Trinayan Sarmah, J Ghosh and M. Kakati

***26th National Symposium on Cryogenics and***

***Superconductivity (NSCS), Variable Energy Cyclotron Center (VECC), Kolkata, 22-24 February 2017***

Scientific software tool for calculation of static heat-in-leak and materials specific heat for cryogenic applications

D. Sonara, V. L. Tanna and S. Pradhan

Instrumentation and Control aspects of MgB<sub>2</sub> Current Leads Test activities

Rohit Panchal, Rakesh Patel, Gaurang Mahesuria, Dashrath Sonara, Pradip Panchal, Dikens Christian, Hiren Nimavat, G. K. Singh, Jal Patel, Vipul L Tanna, Subrata Pradhan

Helium inventory management, quality control and helium losses during SST-1 cryo plant operations

N. Bairagi, J.C. Patel, P. Panchal, R. Panchal, D. Sonara, R. Patel, L.N. Srikanth G, A. Garg, G. Mahesuriya, D. Christian, R. Sharma, H. Nimavat, K. Patel, P. Shah, G. Purwar and V.L. Tanna

Overhauling of Compressor for 1.3 kW/4.5 K capacity Helium Refrigeration / Liquefaction (HRL) Plant at IPR

J. C. Patel, P. R. Shah, K. Patel, Srikanth GLN, R. Panchal, D. Sonara, D. Christian, R. Patel, G. Mahesuriya, P. N. Panchal, N. Bairagi, H. Nimavat, R. Sharma, A. Garg and V. L. Tanna

Design and fabrication of Vacuum Jacketed Transfer Line for Helium Services

Pankil Shah, G.L.N. Srikanth, Ketan Patel, Hiren Nimavat, Jal Patel, Vipul Tanna and Subrata Pradhan

Thermal Performance Enhancement of Liquid Nitrogen Distribution System of SST-1

Rajiv Sharma, Atul Garg, Hiren Nimavat, Gaurav Purwar and V. L. Tanna

***National Conference on Renewable Energy Technology Utilization for Rural Development & Trade Show, North Eastern Hill University, Shillong, India, 27 February -1 March 2017***

Current status of surface assisted volume negative hydrogen ion source at CPP-IPR and its prospect in fusion experiment S.S. Kausik, B. Kakati, B.K. Saikia, M. Bandyopadhyay, D. Kalita and A.G. Gahlaut

***Joint ICTP-IAEA School on Atomic Processes in Plasmas, ICTP, Trieste, Italy, 27 February - 3 March 2017***

Electron temperature measurement using Line intensity ratio

method and Langmuir probe in Argon plasma  
Vara Prasad Kella and Joydeep Ghosh

*International Symposium on Nonlinear Waves in Fluids and Plasmas (BUTIFEST 2017), IIT Delhi, 1-2 March 2017*

A novel approach to produce H<sup>-</sup> ions to improve the production and extraction efficiency of high current H<sup>-</sup> ion source  
B. Kakati, S.S. Kausik, M. Bandyopadhyay, B.K. Saikia and P. K. Kaw

*9th ITER International School (IIS-2017), Aix en Provence, France, 20-24 March 2017*

Observations of MHD modes prior to Disruption in ADITYA-Upgrade Tokamak  
Harshita Raj, J. Ghosh, R. L. Tanna

*A two days symposium on two decades of Ion beam analysis at 3 MV tandetron, NCCCM, National Centre for Compositional Characterization of Materials, BARC, Hyderabad, 23-24 March 2017*

Fusion relevant tungsten dust particles produced by plasma assisted method and studies of their hydrogen absorption properties by NRA technique  
T. Sarmah, N. Aomoa, Sanjiv Kumar and M. Kakati

*UGC-SAP (DRS III) Sponsored National Seminar on Recent Advances in Material Science and their applications, BN College, Dhubri, Assam, 24-25 March 2017*

Tungsten Dust Containing Hydrogen Plasma and its importance of study  
D. Kalita, B.K. Saikia, B. Kakati and S. S. Kausik

An ion source based on Inertial Electrostatic Confinement Fusion for material studies  
N. Buzarbaruah, D. Borgahain and S.R. Mohanty

Size controlled synthesis of super paramagnetic nanoparticles by plasma expansion technique  
Lavita Sarma, Trinayan Sarmah, N. Aomoa, and M. Kakati

Rietveld refinement of tungsten nanoparticles prepared by plasma method  
Trinayan Sarmah, Ngangom Aomoa, Sidananda Sarma and M. Kakati

## AWARDS and ACHIEVEMENTS

Dr. Mukesh Ranjan won the **best oral presentation** in Young Scientist Meet conducted in the International Conference on Nanotechnology for Better Living at NIT, Srinagar jointly organised by IIT-Kanpur and NIT-Srinagar from 25-29 May 2016. The title of his presentation was "Sub-monolayer growth of Ag on flat and nanorippled SiO<sub>2</sub> surfaces"

Shri. Sunil Misal of Administration Division of IPR was awarded the DAE "**Hindi Sevi Samman Puraskaar**" for the year 2014-15 on 31st May 2016 for his commendable contributions in propagation and use of Hindi language in office. The award consisted of a citation and a medal, which was presented to him by the Chief Guest Shri. Anil Kumar, Director General (Security), Dept. of Atomic Energy, Mumbai, at the 17th All India Official Language Conference held at Anushakti Bhavan, DAE Secretariat, Mumbai.

Diagnosis of Trapped Energetic Particles in Source Plasma of LVPD

A. K. Sanyasi, L. M. Awasthi, P. K. Srivastava, S. K. Mattoo, P. K. Kaw and R. Paikaray received **best poster award** at 5th PSSI-Plasma Scholars Colloquium (PSC), Ravenshaw University, Cuttack, 27-28 August 2016

Driving frequency effect on the electron energy distribution function and electron sheath interaction in capacitive discharges: A simulation study

Nishant Sirse, Miles Turner and Albert R Ellingboe, Sarveshwar Sharma and Predhiman K Kaw received **best poster award** at 6th International Conference on Microelectronics and Plasma Technology (ICMAP 2016), Gyeongju, Korea, 26-29 September 2016

Observation of nonlinear coupling between Kelvin-Helmholtz and drift wave instability in IMPED

Sayak Bose, Neeraj Wakde, P.K. Chattopadhyay, J. Ghosh and Y.C. Saxena received **best poster award** at Joint ICTP-IAEA College on Plasma Physics, International Center for Theoretical Physics, Italy, 7-18 November 2016

Design and Implementation of Electromagnetic Diagnostics Electronics in SST-1 Tokamak

Praveenlal Edappala, Chandresh Hansalia, Rachana Rajpal, Hitesh Mandaliya, Vismay Raulji, Sameer Kumar and Raju Daniel received **best paper award** in the thread of Applied Electronics and System Engineering, at 2016 International Conference on Advances in Electrical, Electronic and

Systems Engineering (ICAESE 2016), Putrajaya, Malaysia, 14-16 November 2016

Studies on controlled synthesis of super paramagnetic carbon encapsulated magnetic nanoparticles (CEMN) by plasma expansion technique

Ngangom Aomoa, Lavita Sarma, Trinayan Sarmah, Sidananda Sarma and M. Kakati received **best poster award** at International conference on Advances in Nanotechnology (iCAN-17), Assam Don Bosco University, Guwahati, Assam, India, 9-13 January 2017

Influence of Cold Plasma Treatment on Seed Germination

R. Rane, A. Vaid, C. Nalwa, A. Vikram, A. Thakur, S. Mukherjee received **best oral presentation award** at National Symposium on Advances in Agriculture through Sustainable Technologies & Holistic Approaches (AASTHA-2017), at International Centre, Dona Paula, Goa, 15-17 February 2017

Overview and Status of ITER-India Gyrotron Test Facility (IIGTF)

Vipal Rathod, S.L. Rao, Anjali Sharma, Ronak Shah, Deepak Mandge, Sharan Dilip, Amit Yadav, Rajvi Parmar received **best poster award (second prize)** at National Conference on Emerging Trends in Vacuum Electronic Devices & Applications VEDA 2016, Institute for Plasma Research, India, 16 - 18 March 2017

Professor Subroto Mukherjee, Head, FCIPT and Associate

Dean, Academics, was awarded (jointly with Dr. S C Sharma of ISRO, Thiruvananthapuram) the **VASVIK Award** for the year 2016 in the category of Material & metallurgical Sciences & Technology. This award is instituted by the Vividhlaxi Audyogik Samshodhan Vikas Kendra, Mumbai. The award was presented to him by Shri Pankaj Patel, President, Federation of Indian Chambers of Commerce & Industry (FICCI) during the ceremony organized at BJ Hall, Vile Parle, Mumbai, 3 March 2017

## E. 4. INVITED TALK DELIVERED BY IPR STAFF

### MODHUCHANDRA LAISHRAM

Gave an Invited talk on “Collective dynamics in complex fluid system” at EMN Meeting on Microfluidics and Nanofluidics-2016, Dubai-United Arab Emirates, 5-8 April 2016

### MAINAK BANDYOPADHYAY

Gave an Invited talk on “ROBIN India’s First Fusion Grade Negative Ion Source & its Performance Journey” at CPP-IPR Silver Jubilee Symposium, Assam Don Bosco Institute (DBI), Kharghuli, Guwahati, 21-22 April 2016

### M. KAKATI

Gave an Invited talk on “Controlled plasma fusion research, reports from CPP-IPR on development of a major experimental facility to study plasma surface interaction processes relevant to future fusion machines” at National seminar on Green Energy- Prospects and Challenges, Assam Science and Technology University, Guwahati, Assam, 26 April 2016

### MRITYUNJAY KUNDU

Gave an Invited talk on “Collisional absorption of laser pulses in under-dense plasmas: Anomalous versus normal scenario” at 10th West Lake Symposium and 12th Asia Pacific Plasma Theory Conference (APPTC-2016), West Lake Hillview International Hotel, Hangzhou, China, 9-13 May 2016

Gave an Invited talk on “Anomalous collisional absorption of femto-second laser in plasma: PIC and Monte-Carlo simulations” at International Centre for Theoretical Sciences program on Laser Plasma Accelerator, ICTS-TIFR, Bangalore, 6-17 March 2017

### D CHANDRA, A THYAGARAJA, A SEN and P KAW

Gave an Invited talk on “Shear flow effects on neoclassical tearing modes” at 10th West Lake Symposium and 12th Asia Pacific Plasma Theory Conference (APPTC-2016), West Lake Hillview International Hotel, Hangzhou, China, 9-13 May 2016

### P. A. RAYJADA

Gave an Invited talk on “Hydrogen permeation barrier coatings for fusion reactor applications” at Institute of Minerals and Materials Technology (CSIR-IMMT), Bhubaneswar, Orissa, 23 August 2016

Gave an Invited talk on “Study of Er<sub>2</sub>O<sub>3</sub> film deposition for the fusion reactor applications” at Recent trends in experimental condensed matter Physics (RTECMP-2017), Saurashtra University, Rajkot, 21st March 2017

Gave an Invited talk on “Energy & Nuclear Fusion: Challenges for Materials” at Center for Advanced Materials Engineering Research and Application, Rajiv Gandhi College of Engineering and Technology, Puducherry, 30th March, 2017

#### **S. R. MOHANTY**

Gave an Invited talk on “Basics and Applications of Inertial Electrostatic Confinement Fusion” at Faculty Development Program on Advances in Microelectronics and Plasma Diagnostics, Delhi Technological University, Delhi, 29 August – 02 September 2016

Gave an Invited talk on “High energy density pinch plasma- an unique tool for plasma processing and deposition” at UGC Sponsored National Seminar on Recent advances in material science and their applications, BN College, Dhubri, Assam, 24-25 March 2017

#### **V. TOIGO, D. BOILSON, T. BONICELLI, R. PIOVAN, M. HANADA, A. CHAKRABORTY**

Gave an Invited talk on “A Substantial Step Forward in the Realization of the ITER HNB System: The ITER NBI Test Facility” at 29th Symposium on Fusion Technology (SOFT-2016), Prague, Czech Republic, 5-9 September 2016

#### **SAROJ DAS**

Gave an Invited talk on “Library Spaces and Services” at STC-2016 UGC-HRDC, Rashtriya Uchchatar Shiksha Abhiyan (RUSA), DLIS Gujarat University, Ahmedabad, 30 September 2016

Participated in panel discussion on topic “R&D Library & Information Landscape: Where are we and where are we headed?” at International Conference on Changing Landscape of Science & Technology Libraries, IIT Gandhinagar, 02-04 March 2017

#### **RAMESH KUMAR BUDDU**

Gave an Invited talk on “Laser Welding Process of Austenitic stainless steels and weld properties characterization studies: Few challenges and experience” at Advances in Welding Technology and Automation, Young Professionals Seminar, Indian Institute of Welding, Baroda Branch, Ahmedabad, 1 October 2016

Gave an Invited talk on “Electron beam welding and Laser Beam welding processes: Prospects and Potential applications in manufacturing sector” at TEQIP-II Sponsored Workshop On” Welding Technologies and NDT Techniques “Organized by Engineering Staff College of India, at Hotel Inder Residency, Ahmedabad, 04 March 2017

#### **SARVESHWAR SHARMA**

Gave an Invited talk on “Effect of driving frequency on the electron-sheath interaction and plasma parameters in capacitively coupled plasma discharges” at School of Physical Sciences, Dublin City University, Ireland, 11 October 2016

Gave an Invited talk on “Driving frequency effect on the electron-sheath interaction and electron energy distribution function in Capacitive discharges” (Co-authors: N Sirse, P K Kaw, M M Turner, A R Ellingboe) at Indo-Taiwan Low Temperature Plasma Physics collaborative work, Aerothermal & Plasma Physics Laboratory, National Chiao Tung University, Hsinchu, Taiwan, 21 February 2017

#### **NIRAV I. JAMNAPARA**

Gave an Invited talk on “Applications of plasma technologies in Defense Sector: Development, Performance & Disposal” at International Conference on Emerging Materials & Processes for Defense & Infrastructure, CIDCO Exhibition Centre, Vashi, Navi Mumbai, 13 October 2016

Gave an Invited talk on “Plasma Aided Surface Engineering: Exploring Novel Applications” at TEQIP-II research strand lecture series, SS Engineering College, Govt. of Gujarat, Bhavnagar, 07 March 2017

Gave an Invited talk on “Development of hard automobile components using plasma” (Co-authors: Alphonsa Joseph, S. Mukherjee) at AES Seminar - Convergence of Technologies in Automotive Plant & Workshop on Surface Engineering in Automotive Industry, New Delhi, 21 March 2017

#### **MUKESH RANJAN**

Gave an Invited talk on “Plasma Based Nanotechnologies at FCIPT/IPR” at XXXI Annual IAPT Convention 2016 & Symposium on Excellence in Research, LDRP, Gandhinagar, 20-22 October 2016

Gave an Invited talk on “Plasma based technologies in

Nanotechnology” at Samvad, Aditya Silver Oak Institute of Technology, Ahmedabad, 22 December 2016

#### **G. RAVI**

Gave an Invited talk on “Physics and Technology of Thermal Plasmas” at 31st National Convention of Indian Association of Physics Teachers and Symposium on Excellence in Research, Kadi Sarva Vishvavidyalaya, Gandhinagar, 21 October 2016

#### **DEVENDRA SHARMA**

Gave an Invited talk on “Simulations of nonlinear plasma structures, phase space coherence to vortex dynamics” at International Conference on Frontiers of Physics and Plasma Science, Dep. of Physics and Mathematics, Ujjain, India, 7 November 2016

#### **AMITA DAS**

Gave series of Invited lectures on topics: fluid models, plasma instabilities, nonlinear processes, coherent structures and plasma turbulence, at SERB school organized by Dr. H. Bailing at The Institute of Advanced Study in Science & Technology (IASST), 21-25 November 2016

Organized a workshop along with G. Ravindra Kumar (TIFR), M. Krishnamurthy (TIFR Hyd), Srinivas Krishnagopar (BARC) and Rajeev Pattathil (RAL, UK) on “Laser Plasma Accelerator”, at International Centre for Theoretical Sciences, Bangalore and gave an Introductory talk on “Plasma Based Particle Acceleration” and a Technical talk on “Magnetic field generation in finite beam Plasma System”, 6-17 March 2017

**RAMESH JOSHI, H M JADAV, ANIRUDDH MALI and S.V. KULKARNI**

Gave an Invited talk on “Integration of PLC based Offline impedance Matching system for ICRH Experiments” at 2nd international conference on contemporary computing and informatics, Amity University, Noida, 14-17 December 2016

**JOYDEEP GHOSH, RITU DEY, M. B. CHOWDHURI, R MANCHANDA, S. BANERJEE, N. YADAVA, NILAM NIMAVAT and ADITYA TEAM**

Gave an Invited talk on “Neutral Particle Transport in Aditya

Tokamak Plasmas” at 21st National Conference in Atomic and Molecular Physics (NCAMP-2017), Physical Research Laboratory, Ahmedabad, Gujarat, India, 3-6 January 2017

#### **HITENSINH VAGHELA**

Gave an Invited talk on “Cryogenic System of ITER: Cryogenic Distribution and System of Cryolines” at TKM College of Engineering, Karicode, Kerala, 27 January 2017

#### **RAJESH TRIVEDI**

Gave an Invited talk on “Lesson learnt from development of ITER MW level R&D RF source in MHz frequency range” at Workshop on RF Systems for Accelerators, Inter-University Accelerator Centre, New Delhi, 6-8 February 2017

#### **S.V. KULKARNI**

Gave an Invited talk on “High Power RF and Microwave requirements for Fusion Reactor and Safety Aspects” at Workshop on RF Systems for Accelerators, Inter-University Accelerator Centre, New Delhi, 6-8 February 2017

#### **V. L. TANNA**

Gave an Invited talk on “SST-1 Cryogenics and related facilities at IPR” at 26th National Symposium on Cryogenics and Superconductivity (NSCS), Variable Energy Cyclotron Center (VECC), Kolkata, 22 February 2017

#### **NITIN SHAH**

Gave an Invited talk on “ITER Cryolines” at 26th National Symposium on Cryogenics and Superconductivity (NSCS), Variable Energy Cyclotron Center (VECC), Kolkata, 23 February 2017

#### **MUKTI RANJAN JANA**

Gave an Invited talk on “High Power Ion Acceleration System for Tokamak Plasma Heating” at Indo Japan Accelerator School (IJAS) 2017, Department of Physics, Indian Institute of Technology Roorkee, 9-11 March 2017

#### **KUSHAGRA NIGAM**

Gave an Invited talk on “Physics of 4th State of Matter” and “Quantum Dynamics of Casimir Forces” at BITS Pilani K.K. Birla Goa Campus, on 17 and 18 March 2017

*Endowment Lecture / Invited talks given at 33rd DAE Safety & Occupational Health Professionals Meet, Institute for Plasma Research, Gandhinagar, 23-25 November 2016*

**P. I. JOHN** gave an Endowment Lecture on “Energy and Environment: Plasma Processes for Decarbonization”

**U.K. BARUAH** gave an Invited talk on “Occupational Hazards with Experimental High Voltage Systems”

**SANJAY V. KULKARNI** gave an Invited talk on “Safety Aspects of High Power RF and Microwave Sources for Fusion Reactor”

## **E.5 TALKS DELIVERED BY DISTINGUISHED VISITORS AT IPR**

Dr. Charu Lata Dube, Immobilisation Science Laboratory, Department of Materials Science and Engineering, University of Sheffield, UK, gave a talk on “Radiation stability of nuclear materials for nuclear power generation”

Dr. Manis Chaudhuri, School of Engineering and Applied Sciences, Harvard University, USA, gave a talk on “Exploring strong coupling phenomena in classical many body systems: from dusty plasma to colloids”

Dr. Dinesh Nath, Indian Institute of Technology, Kanpur, gave a talk on “Application of meshless methods to the computation of fixed boundary equilibria and current-hole simulation in tokamak”

Mr. Satish Badgular, ITER Organization, France, gave a talk on “Realization of the Cryoline System for ITER”

Mr. Shailesh Kanpara, Institute for Magnetic Fusion Research, IRFM-CEA, Cadarache, France, gave a talk on “Development of Tungsten (W) Coating technologies for Plasma Facing Component application”

Dr. Gopikishan Sabavath, Birla Institute of Technology, Mesra, Ranchi, gave a talk on “Plasma parameters and instability during thin film deposition”

Dr. J. K. Atul, Magadh University, Bodh Gaya, India, gave a talk on “Secondary Instabilities in the Dynamics of Farley Buneman Fluctuations”

Dr. Sanat Kumar Tiwari, Department of Physics and Astronomy, University of Iowa, U.S.A, gave a talk on “Thermodynamic State Variables in Ultracold Plasmas”

Dr. Arvind Kumar Saxena, Max-Planck Center for Attosecond Science, POSTECH, South Korea, gave a talk on “Study of Clusters using Mass Spectrometry, Optical Spectroscopy and Imaging technique”

Dr. Karan Pankaj Jani, Georgia Institute of Technology-USA, LIGO Scientific Collaboration, gave a talk on “Journey of Binary Black Holes: From Supercomputer to LIGO to Universe”

Dr. Bernard Bigot, Director-General, ITER Organization, gave a talk on “Progress of the ITER Project”

Dr. A K Patra, National Atmospheric Research Laboratory, Gadanki, AP, India, gave a talk on “The puzzling daytime 150-km echoes: Are they due to plasma instability or naturally enhanced plasma waves?”

Dr. Tapan Barman, Institute of Advanced Study in Science and Technology, Guwahati, Assam, gave a talk on “Synthesis of polyaniline-Au nanocomposite thin films by plasma-based techniques for flexible self-powered photodetectors”

Dr. Payal H. Pandit, Kadi Sarva Vishwavidyalaya, Gandhinagar, gave a talk on “Direct Measurement of Plasma Potential using Laser Heated Emissive Probes”

Dr. Prabal Singh Verma, Technische Universitat Berlin, Germany, and Max-Planck/Princeton Center for Plasma Physics, gave a talk on “Fourth order accurate finite volume numerics for simulating accretion disks”

Dr. Yeshwant R. Waghmare, (Former Prof. and Dean), Indian Institute of Technology, Kanpur, gave a talk on “Is Quantum Theory the Ultimate Reality?”

Dr. Mohit P Sharma, DGFS PhD, HBNI, BARC, Mumbai, gave a talk on “Investigation on the flow distribution within the rod bundle of AHWR”

Dr. Ravi B. Grover, Homi Bhabha National Institute, Mumbai, gave a talk on “The Journey Leading to India Joining ITER”

Prof. James Bradley, Department of Electrical Engineering and Electronics, University of Liverpool, UK, gave a talk on



“Plasma discharges for the ambient processing and detection of materials”

Dr. Rahul Kumar, Institute for Cosmic Ray Research (ICRR), University of Tokyo, gave a talk on “KAGRA detector: Large-Scale Cryogenic Gravitational Wave Telescope”

Dr. Subir Biswas, Weizmann Institute of Science, Israel, gave Dr. Parvez Guzdar award talk on “Spectroscopic Diagnosis of Magnetic and Electric Field and Plasma Properties in a Relativistic Electron Beam Diode”

Dr. Ujjwal Sinha, GoLP/IPFN, Instituto de Plasmas e Fusao Nuclear, Instituto Superior Tecnico, Lisbon, Portugal, gave a talk on “Circularly Polarized Light from Magnetized Current Filaments: implications to Gamma Ray Bursts”

Dr. M.D. Pandya, University of Wisconsin-Madison, USA, gave a talk on “Low edge safety factor disruptions in the Compact Toroidal Hybrid: Operation in the low-q regime, passive disruption avoidance and the nature of MHD precursors”

Dr. Sukanya Mitra, Indian Institute of Technology, Gandhinagar, gave a talk on “Electromagnetic Responses and Dissipative Properties in Hot QCD Medium”

Mr. M.Y. Jamal, Indian Institute of Technology, Gandhinagar, gave a talk on “Collective Modes and the Refractive Index of hot QCD/QGP medium”

Dr. Sunil Kumar, Inter University Accelerator Centre (IUAC), New Delhi, gave a talk on “Irradiation induced structural and electrical modification in graphene”

Mr. Avdhesh Kumar, Physical Research Laboratory, Ahmedabad, gave a talk on “On the Chiral Imbalance and Weibel Instabilities”

## **E 6. COLLOQUIA PRESENTED AT IPR**

Prof. Krishna Kumar, Department of Physics, Indian Institute of Technology, Kharagpur, West Bengal, on “Fluid patterns in thermal convection with rotation” (Colloquium # 259)

Prof. Edward Thomas Jr., Physics Department, Auburn University, Auburn, Alabama, USA, on “The Magnetized

Dusty Plasma Experiment (MDPX) as a platform for basic and applied plasma physics research” (Colloquium # 260)

Prof. Jayanta Bhattacharjee, Harish-Chandra Research Institute, Allahabad, India, on “Scaling Law for Turbulence in Stratified Fluids: Kolmogorov or Bolgiano?” (Colloquium # 261)

Dr. Nirmal Kumar Bisai, Institute for Plasma Research, Gandhinagar, Gujarat, on “Role of neutral gas in Scrape-off Layer of tokamak plasmas in the presence of finite electron temperature gradient” (Colloquium # 262)

Prof. Vijay A. Singh, Raja Ramanna Fellow, Mumbai University, Mumbai, on “The Golden Ratio, the Centre of Mass and Aesthetics” (Colloquium # 263)

Prof. Vijay A. Singh, Raja Ramanna Fellow, Mumbai University, Mumbai, on “Science Education: An Art or a Science?” (Colloquium # 264)

Dr. Vinod Chandra, Indian Institute of Technology, Gandhinagar, on “Exploring the heart of the matter: the hottest and most fluid, liquid in nature at extreme temperature/energy density” (Colloquium # 265)

Prof. Rajesh Gopakumar, International Centre for Theoretical Sciences-TIFR, Bangalore, on “Down-To-Earth String Theory” (Colloquium # 266)

Prof. H. Bailung, Professor and Head, Physical Sciences Division, IASST, Guwahati, on “Ion Acoustic rouge waves in multicomponent plasma” (Colloquium # 267)

Prof. G.P. Zank, Eminent Scholar, Distinguished Professor and Director, Centre for Space Physics and Aeronomic Research, University of Alabama, Huntsville, USA, on “A Nearly Incompressible Description of Low-Frequency Turbulence” (Colloquium # 268)

Prof. Avinash Khare, Department of Physics and Astrophysics, University of Delhi, on “Creation of General relativity: Einstein and Hilbert” (Colloquium # 269)

## **E.7 SCIENTIFIC MEETINGS HOSTED BY IPR**

*National Conference on Emerging Research Trends*

***in Engineering (NCERTE), Vishwakarma Govt. Engg. College, Ahmedabad, 4-6 April 2016***

National Conference on Emerging Research Trends in Engineering (NCERTE)–2016 was organized at Vishwakarma Govt. Engg. College – Chandkheda, Ahmedabad from 4<sup>th</sup> – 6<sup>th</sup> April 2016 in collaboration with SPFU, CTE, Institute for Plasma Research, and TEQIP – II Institutes of the state. The conference received more than 250 papers in various engineering disciplines, and out of that, approximately, 200 papers were selected for oral/poster presentations. There were three plenary talks and 27 expert talks throughout the conference. Prof. Amita Das (Dean – IPR) was one of plenary speakers in addition to Dr. Sudhir Jain (Director, IIT – Gandhinagar) and Shri N. M. Desai (Deputy Director – SAC, Ahmedabad). Prof. Amita Das talked about plasma physics, nuclear fusion and various societal benefits of plasma science. She also briefed participants about various research activities carried out at IPR. It was well received by the attendees. The conference was inaugurated on 4<sup>th</sup> April in the presence of Dr. M. N. Patel (Vice Chancellor, Gujarat University), Dr. Sudhir Jain (Director, IIT – Gandhinagar), Dr. V. S. Purani (Jt. Director, CTE), Prof. Usha Neelakantan (SPFU – Coordinator), Dr. Subroto Mukherji (Associate Dean, IPR), Dr. R. K. Gajjar (Principal, VGEC – Chandkheda), Dr. R. A. Thakker (Coordinator, NCERTE – 2016) and other dignitaries, authors, faculty and student participants of VGEC and other Institutes. Overall, there was excellent response from the participants, hence making the NCERTE – 2016 a very successful event.

***19th Joint Workshop (EC-19) on Electron Cyclotron Emission (ECE) and Electron Cyclotron Resonance Heating (ECRH), Institute for Plasma Research, Gandhinagar, 04-07 April 2016***

19th Joint workshop in Electron Cyclotron Emission (ECE) and Electron cyclotron Resonance Heating (ECRH) was hosted by Institute for Plasma Research, from 4<sup>th</sup> -7<sup>th</sup> April, 2016 at Narayani Heights, located near its premises at Bhat, Gandhinagar. This bi-annual meeting, mainly covered the major areas as: Electron cyclotron (EC-wave) theory, electron cyclotron emission (ECE), electron cyclotron resonance heating (ECRH), electron Cyclotron current drive (ECCD), Experiments on various tokamaks and Stellarators and Technology associated with ECE and ECRH. More than 60 members of the science and fusion community participated in this important event, which included more than 30 international participants. The conference was inaugurated by

the traditional lighting of the lamp by the various dignitaries attending the conference. Along with the technical sessions related ECE and ECRH, members participated and enjoyed an evening of Indian cultural program and the dinner hosted by Director at IPR. Local sightseeing was also arranged for the participants and they visited the Adalaj step well, Gandhi Ashram and ended with a traditional Gujarati dinner at Vishala, Ahmedabad.

***Centre of Plasma Physics – Institute for Plasma Research (CPP-IPR) Silver Jubilee Symposium, Nazirakhat, Tepesia, Sonapur, Kamrup, Assam, 21-22 April 2016***

Centre of Plasma Physics- Institute for Plasma Research (CPP-IPR) celebrated its silver jubilee with a symposium titled, “CPP-IPR Silver Jubilee Symposium”. The decorous two day program was held at Don Bosco Institute, Guwahati. On 21<sup>st</sup> April 2016, the program started with the welcome address by the Centre Director, Prof. K. S. Goswami. The program continued with the felicitation of Prof. S. Bujarbarua, founder director, CPP and Prof. P. K. Kaw, former Director, IPR, for their monumental contribution towards the institute. Prof. Bujarbarua elaborated the commissioning of CPP and merging it with IPR. Prof. Kaw praised and motivated the constant effort of the researchers of the institute towards solving world class problems. The meeting was graced by the presence of many dignitaries including, Prof. J. N. Goswami, Prof. B. N. Goswami, Prof. Y. C. Saxena, Prof. A. C. Das, Prof. Jayanti Chutia, Prof. H. Bailung, Prof. K. D. krori, Fr. Joseph (Pro-VC Assam Don Bosco university) etc. The special attraction of the symposium was a student interaction with Prof. J. N. Goswami, Prof. B. N. Goswami, Prof. A. C. Das and Prof. Asoke Kumar Sen (Assam University). The session was coordinated by Prof. Y. C. Saxena. In the afternoon the delegates and students were taken to CPP-IPR for the laboratory visit. On, 22<sup>nd</sup> April, 2016, technical lectures were delivered by Dr. Subrata Pradhan, Prof. Amita Das, Dr. Jaydeep Ghosh, Dr. Mainak Bandopadhyay, Dr. Ujjal Barua and Prof. M. P. Bora (Gauhati University). Dr. Pradhan spoke about the recent developments of SST-1 and Prof. Amita Das touched upon the physics and engineering challenges in magnetic fusion. Dr. M. Kakati presented the recent commissioning of the CIMPLE-PSI device. In the session after lunch, posters from various institutions were presented.

***One-Day Workshop on Thermal Plasma and its Industrial Applications, FCIPT, IPR, Gandhinagar, 29 April 2016***

A one day workshop on Thermal Plasma and its Industrial Applications was organized by FCIPT on 29th April 2016. The aim of this workshop was to sensitize industries about how thermal plasmas can be used for industries in the field of waste management, nano-material production, ceramic/mineral processing etc. The workshop was attended by around 50 participants from various industries. Participants were excited to see Plasma Pyrolysis, Nano-Powder Production and Plasma Torch during laboratory visit.

***International Yoga Day Celebration @ IPR, Gandhinagar, 21 June 2016***

As per the directives received from Ministry of AYUSH, Govt. of India, IPR celebrated the International Yoga Day on 21st June 2016 in the lawns of the main campus. The theme of the programme was “Yoga for Harmony and Peace”. A Yoga demonstration session of around forty five minutes was organized in which students, faculty and administrative staff took part enthusiastically. Under the guidance of three invited experts, various Yoga postures and asanas were performed. Yoga session started with a little prayer followed by Sookshma Vyayam, Vajrasana, Tadasana, Vrikshashana, Surya Namaskar, Nadi Shodhan Pranayama and Bhramaree Pranayama. IPR Staff members participated in these session were very satisfied as the Yoga session was quite a relaxing and refreshing experience for them. After a light refreshment, an interactive talk on “Benefits of Yoga for stress management and good health” was arranged in the packed seminar hall in which the Yoga experts explained as to how the Yoga helps in releasing the stress and can be useful for the better living

***46th National Safety Week, IPR, Gandhinagar, 4-10 March 2017***

The 46th National Safety Week was celebrated at IPR during 4-10 March 2017. The institute organized various competitions in this week to create safety awareness among the employees. Competitions include Slogan in Hindi & English, Cartoon Making, Quiz and Essay Writing in Hindi & English based on decided topics for the employees of IPR, FCIPT & ITER-India. Encouraging response was received from the employees for various competitions. A hands-on demonstration for using fire extinguisher was conducted for the employees as well as security staff at IPR, FCIPT and IPR Extension labs as a part of the Safety Week. A demonstration of self-contained breathing apparatus (SCBA) was also conducted for the employees, specially for those who work with cryogenic fluids. The concluding

session was organized on 10th March 2017. Mr. Devendra Modi welcomed the gathering and Mr. Rajiv Sharma made a presentation on “Experience with Cryogenic Safety, Problems and Solutions”. This was followed by a talk by Dr. Chenna Reddy who expressed his thoughts on safety at work. The safety pledge was then administered to the staff by Shri. P K Atrey. This was followed by a safety quiz conducted by Shri Bharat Doshi. IPR Director then delivered the keynote address and gave away the prizes to the winners of various competitions organized during the safety Week. The vote of thanks was delivered by Shri Sunil Kumar, Chairman, Safety Committee.

***National Conference on Emerging Trends in Vacuum Electronic Devices and Applications (VEDA ), IPR, Gandhinagar, 16-18 March 2017***

The National Conference on Emerging Trends in Vacuum Electronic Devices and Applications (VEDA) was hosted by IPR in collaboration with the Vacuum Electronics & Applications Society, Bengaluru during 16-18 March 2017. The event was inaugurated by Dr. Shashank Chaturvedi, Director IPR, Dr. Sushil Raina, President VEDA Society and Dr. Sudhir Kamath (Director, MTRDC), who also delivered the keynote address. The meeting had six plenary and sixteen invited talks by leading experts in the fields of vacuum devices and high power microwaves. The meeting also had oral presentations as well as a poster session. Around 100 participants from various R&D institutions and Universities took part in this event.

## **E.8 MoU SIGNED**

### **E.8.1 NATIONAL MoU SIGNED**

#### **IPR-St. Xavier’s Teaching Collaboration**

As part of the ongoing teaching collaboration with St. Xavier College (Ahmedabad), Dr. Mukesh Ranjan from FCIPT was invited to deliver a talk on latest trends in plasma based nanotechnology activities. Talk was mainly attended by students and the faculties of St. Xavier College. The talk was arranged to motivate the young students for pursuing the career in research and possible opportunities to work at FCIPT/IPR. This is part of the MoU signed between IPR and St. Xavier’s college Ahmedabad.

## E.8.2 INTERNATIONAL MoU SIGNED

### MoU between IPR & IEK-4

The Institute of Energy and Climate Research - Plasma Physics (IEK-4), Forschungszentrum Juelich GmbH (FZJ), Germany and the Institute for Plasma Research (IPR), recognizing the mutual benefits obtainable in the field of Nuclear Fusion from the research cooperation on fusion science and technology between the two Institutes, have signed a Memorandum of Understanding (MoU) for academic and research cooperation. This MoU, which comes under the umbrella agreement between Government of India and The Institute of Energy and Climate Research - Plasma Physics (IEK-4), Forschungszentrum Juelich GMBH, Germany in the field of fusion energy research, was signed on 28th April, 2016 by the Directors of IPR and IEK-4. Under this five year MoU (renewable), cooperative and joint research activities will be initiated on areas of fusion science and technology, such as fusion material development, plasma material interaction studies, tungsten – plasma spectroscopy and related technology, and on the plasma and fusion experimental programs of both Institutes. There would also be exchange of researchers and PhD students between the two institutes with the intent of learning, training, lecturing, conducting seminars and engaging in workshops and research.

## E.9. TECHNOLOGY TRANSFERS

### 1. Transfer of ‘Atmospheric Pressure Plasma Jet Technology (APPJ)’ on non-exclusive basis to M/s Aditya High Vacuum Pvt. Ltd., Ahmedabad

The atmospheric pressure plasma jet technology for bio-medical applications was transferred by IPR to Ahmedabad based company, M/s Aditya High Vacuum Pvt. Ltd. on non-exclusive basis. The technology knowhow and license agreement was signed on 23-June-2016 at IPR, Bhat, Gandhinagar in the presence of Director IPR. The company plans to commercialize the atmospheric pressure plasma jet to various organizations in the field of bio-medical applications.

### 2. Transfer of ‘Nanopowder production technology’ on non-exclusive basis to M/s Plasma & Vacuum Techniques, Ahmedabad

The ‘Nanopowder production technology’ for production of metal oxide nano particles was transferred on non-exclusive basis to M/s Plasma & Vacuum Techniques, an Ahmedabad based firm working exclusively on plasma and vacuum technologies. The agreement was signed on 8th July 2017 at IPR, Bhat Gandhinagar in the presence of Director, IPR. The company intends to design, manufacture and supply nano powder production systems to user industries involved in production of Nano powders.



*Shri A. Varadarajulu from IPR (Left) & Dr. N. Venkatramani from Aditya High Vacuum exchanging the technology transfer document*

### 3. Transfer of ‘Plasma Pyrolysis Technology for organic (non-biomedical waste)’ on non-exclusive basis to M/s Bhakti Energy, Rajkot

The plasma pyrolysis technology for non-biomedical waste was transferred on non-exclusive basis to M/s Bhakti Energy, Rajkot on 29th August 2016 at IPR, Bhat Gandhinagar. The company is into the field of renewable energy and intends to develop, supply and install plasma pyrolysis based waste disposal systems with or without energy recovery possibilities

**4. Transfer of ‘Atmospheric Pressure Inline Plasma Treatment Technology for textiles’ on non-exclusive basis to M/s Arshad Electronics Pvt. Ltd., Mumbai**

IPR had developed and patented atmospheric pressure inline plasma treatment system which can be used for textile and film processing. The said technology was transferred on non-exclusive basis to M/s Arshad Electronics Pvt. Ltd., Mumbai on 9-Nov-2016 at IPR, Bhat, Gandhinagar in the presence of Director IPR.



*Exchange of technology transfer agreement between Chairman SPC, IPR (left) and Proprietor, Bhakti Energy (right) in the presence of Director, IPR (Middle)*

**5. Transfer of ‘Plasma Pyrolysis Technology for organic (non-biomedical waste)’ on non-exclusive basis to M/s G P Green Energy Systems Pvt. Ltd., Kolkata**

The plasma pyrolysis technology was transferred to M/s G P Green Energy Systems Pvt. Ltd., a Kolkata based firm engaged in the field of manufacturing gasification systems for energy recovery. The agreement was signed on 7-Dec-2016 at IPR, Bhat Gandhiangar in presence of Director IPR. The company plans to explore plasma technology for next generation waste disposal needs to destroy complex molecules which are not disposable through conventional gasification systems.

--!!--



*Exchange of technology transfer agreement between Proprietor, M/s Arshad Electronics (left) and Dr. Chenna Reddy in presence of Director IPR (Middle).*





Audited Statements of Accounts  
as on 31<sup>st</sup> March 2017  
INSTITUTE FOR PLASMA  
RESEARCH

Registration No.GUJ/88/GANDHINAGAR

**RAMANLAL G. SHAH & CO.**

CHARTERED ACCOUNTANTS

TELEPHONE : 26578619, 26575530

FAX : 079 - 26575401

E-MAIL : ramanlalshahandco@gmail.com

SHREEJI HOUSE

BEHIND M J LIBRARY

ELLIS BRIDGE

AHMEDABAD 380 008

**INDEPENDENT AUDITOR'S REPORT**

**Report on the Financial Statements**

1. We have audited the attached Balance Sheet of **INSTITUTE FOR PLASMA RESEARCH, BHAT, GANDHINAGAR - 382 428** as at 31<sup>st</sup> March, 2017, Income & Expenditure Account and also the Receipts and Payments Account for the year ended on that date annexed thereto.

**Management's Responsibility for the Financial Statements**

2. These Financial Statements are the responsibility of the Institute's management. This responsibility includes the design, implementation and maintenance of internal control relevant to the preparation and presentation of the financial statements that give a true and fair view and are free from material misstatement, whether due to fraud or error.

**Auditor's Responsibility**

3. Our responsibility is to express an opinion on these financial statements based on our audit. We conducted our audit in accordance with the Standards on Auditing issued by the Institute of Chartered Accountants of India. Those Standards require that we comply with ethical requirements and plan and perform the audit to obtain reasonable assurance about whether the financial statements are free from material misstatement. An audit involves performing procedures to obtain audit evidence about the amounts and disclosures in the financial statements. The procedures selected depend on the auditor's judgment, including the assessment of the risks of material misstatement of the financial statements, whether due to fraud or error. In making those risk assessments, the auditor considers internal control relevant to the Institute's preparation and fair presentation of the financial statements in order to design audit procedures that are appropriate in the circumstances. An audit also includes evaluating the appropriateness of accounting policies used and the reasonableness of the accounting estimates made by management, as well as evaluating the overall presentation of the financial statements. We believe that the audit evidence we have obtained is sufficient and appropriate to provide a basis for our audit opinion.



RAMANLAL G. SHAH & CO.

CONTINUATION SHEET

Opinion

4. In our opinion and to the best of our information and according to the explanations given to us, the financial statements give the information required by the Act in the manner so required and give a true and fair view in conformity with the accounting principles generally accepted in India:
- (a) in the case of the Balance Sheet, of the state of affairs of the Institute as at 31<sup>st</sup> March, 2017;
  - (b) in the case of the Income & Expenditure Account, of the excess of Expenditure over Income for the year ended on that date;
  - (c) in the case of the Receipts and Payments Account, of the receipts and payments for the year ended on that date.

Place: Gandhinagar

Dated: May 31, 2017

For Ramanlal G. Shah & Co.,  
Chartered Accountants  
Firm Registration No. 108517W



*Sandeep R. Sutaria*

(Sandeep R. Sutaria)  
Partner  
Membership No.10228

**INSTITUTE FOR PLASMA RESEARCH**  
**BHAT, GANDHINAGAR – 382 428**  
(Sponsored by Dept. of Atomic Energy, Govt. of India, Mumbai)  
Registration No. GUJ/88/GANDHINAGAR

**CONSOLIDATED BALANCE SHEET AS AT 31ST MARCH, 2017**

<u>CORPUS/CAPITAL FUND AND LIABILITIES</u>	SCH.	2016-17	2015-16
CORPUS/CAPITAL FUND	1	5,846,550,099.00	5,695,034,488.00
RESERVES AND SURPLUS	2	12,934,357,270.00	12,703,922,682.00
EARMARKED/ ENDOWMENT FUNDS	3	371,312,424.00	379,879,361.00
CURRENT LIABILITIES AND PROVISIONS	4	2,535,027,140.00	1,881,432,866.00
<b>TOTAL</b>		<b>21,687,246,933.00</b>	<b>20,660,269,397.00</b>
<b><u>ASSETS</u></b>			
FIXED ASSETS	5	9,432,490,405.00	8,506,598,771.00
CURRENT ASSETS, LOANS, ADVANCES ETC.	6	12,254,756,528.00	12,153,670,626.00
<b>TOTAL</b>		<b>21,687,246,933.00</b>	<b>20,660,269,397.00</b>

SIGNIFICANT ACCOUNTING POLICIES	13
CONTINGENT LIABILITIES AND NOTES ON ACCOUNTS	14

As per our report of even date attached.

**For Ramanlal G Shah & Co**  
Chartered Accountants  
Firm Registration No.108517W

-Sd-  
**(Dr. Shashank Chaturvedi)**  
Director

-Sd-  
**(Ujjwal Kumar Baruah)**  
Dean

-Sd-  
**(H.K.Sharma)**  
Accounts Officer-II

-Sd-  
**(Sandeep R. Sutaria)**  
Partner  
Membership No.10228

Place : Gandhinagar  
Dated : May 31, 2017

**CONSOLIDATED INCOME AND EXPENDITURE ACCOUNT FOR THE PERIOD ENDED  
ON 31ST MARCH, 2017**

<b><u>A.INCOME</u></b>	<b>SCH.</b>	<b>2016-17</b>	<b>2015-16</b>
Grants- Department of Atomic Energy, Govt. of India	7	5,121,902,000.00	8,040,963,193.00
Interest Earned	8	265,024,489.00	192,172,184.00
Other Income	9	10,719,790.00	6,981,719.00
Profit on sale of Assets		-	-
<b>TOTAL (A)</b>		<b>5,397,646,279.00</b>	<b>8,240,117,096.00</b>
<b><u>B. EXPENDITURE</u></b>			
Establishment Expenses	10	1,574,282,995.00	1,031,425,910.00
Other Administrative Expenses	11	1,058,964,502.00	855,215,268.00
Depreciation & Ammortisation of Intengible Assets	12	451,795,596.00	387,489,943.00
Less : Transfer from Corpus/Capital Fund		(451,795,596.00)	(387,489,943.00)
National Fusion Programme (Human Resource Development Expenses)		1,487,271.00	3,354,497.00
Cash Contribution to ITER IO		1,926,317,306.00	1,061,176,413.00
Loss on Disposal of Capital Assets/ Write off		223,675.00	257,069.00
<b>TOTAL (B)</b>		<b>4,561,275,749.00</b>	<b>2,951,429,157.00</b>
<b>Balance being excess of Income over Expenditure/ (Excess of Expenditure over Income)</b>		<b>836,370,530.00</b>	<b>5,288,687,939.00</b>
Transfer to Corpus Fund for addition to Movable & Immovable Properties		607,137,134.00	1,366,403,745.00
Transfer From Corpus Fund for w/off to Movable & Immovable Properties		607,192.00	(20,012,386.00)
Transfer to Iter-India Fund (Interest Earned)		146,642,599.00	141,328,743.00
Transfer to/from unspent Grant A/c		83,197,989.00	3,800,967,837.00
SIGNIFICANT ACCOUNTING POLICIES	13		
CONTINGENT LIABILITIES AND NOTES ON ACCOUNTS	14		

As per our report of even date attached.

Chartered Accountants  
Firm Registration No.108517W

-Sd-  
**(Dr.Shashank Chaturvedi)**  
Director

-Sd-  
**(Ujjwal Kumar Baruah)**  
Dean

-Sd-  
**(H.K.Sharma)**  
Accounts Officer-II

-Sd-  
**(Sandeep R. Sutaria)**  
Partner  
Membership No.10228

Place : Gandhinagar  
Dated : May 31, 2017

**INSTITUTE FOR PLASMA RESEARCH  
BHAT, GANDHINAGAR – 382 428**  
(Sponsored by Dept. of Atomic Energy, Govt. of India, Mumbai)  
Registration No. GUJ/88/GANDHINAGAR

## CONSOLIDATED RECEIPTS AND PAYMENTS FOR THE PERIOD ENDED ON 31ST MARCH, 2017

RECEIPTS	2016-17	2015-16	PAYMENTS	2016-17	2015-16
<b>I. Opening Balances</b>			<b>I. Expenses</b>		
a) Cash in hand	45,438.00	36,841.00	a) Establishment Expenses	948,526,173.00	817,019,970.00
b) Bank Balances			b) Administrative Expenses	1,021,806,027.00	849,151,652.00
i) In Current accounts	47,877,907.00	79,041,538.00	c) National Fusion Programme	1,487,271.00	3,354,497.00
ii) In deposit accounts	3,999,812,851.00	1,598,801,121.00	d) Cash Contribution to ITER-IO	1,926,317,306.00	1,061,176,413.00
iii) Savings accounts	52,082,888.00	3,343,773.00			
iv) Margin Money with Bank	-	7,813,000.00	<b>II. Exp. on Fixed Assets, Cap. WIP &amp; Others</b>		
			a) Purchase of Fixed Assets & other exp.	608,324,413.00	1,091,380,571.00
			b) Expenditure on Capital WIP	780,770,104.00	184,132,888.00
<b>II. Grant Received</b>			<b>III. Refund of Surplus money/Loans</b>		
a) From Govt. of India- DAE	5,121,902,000.00	7,998,388,000.00	a) Deposits with Government Auth. & Suppliers/Security Deposits	1,962,432.00	30,693,613.00
			b) Payments against Earmarked Funds	42,321,706.00	96,924,935.00
<b>III. Interest Received</b>			<b>IV. Other Payments (Specify)</b>		
a) On Bank Deposits	267,866,841.00	173,529,661.00	a) Advances to Contractors & Suppliers (Including Adv. for Capital Works)	1,451,206,887.00	2,187,504,717.00
b) Loans, Advances etc.	1,329,355.00	1,567,571.00	b) Deposits with Government Auth. & Suppliers / Security Deposits	10,000.00	3,391,824.00
c) Int on I.T Refund	42,719.00	129,711.00	c) Stock (Change in closing Bal.)		
<b>IV. Other Income</b>			d) Payment of LT Advances to Empl.	160,000.00	1,405,061.00
Misc Income	5,520,789.00	6,674,437.00	e) Others	5,702,128.50	9,776,137.00
Royalty & Transfer Fee Income	4,204,300.00	251,282.00	a) Cash in hand	39,550.00	45,438.00
<b>V. Any Other receipts</b>			b) Bank Balances		
Amount received for Earmarked/Endowment Funds	33,704,769.00	85,582,743.00	i) In Current accounts	42,780,166.00	47,877,907.00
Security Deposits	16,819,498.00	478,115,380.00	ii) In deposit accounts	2,989,889,349.00	3,999,812,851.00
Others	299,031,155.00	478,115,380.00	iii) Savings accounts	28,534,674.00	52,082,888.00
Receipt of LT Advances to Empl.	2,410,841.00	2,104,100.00	iv) Margin Money with Bank	3,015,000.00	-
Sale of Capital Assets	201,836.00	352,204.00			
<b>TOTAL</b>	<b>9,852,853,187.00</b>	<b>10,435,731,362.00</b>	<b>TOTAL</b>	<b>9,852,853,187.00</b>	<b>10,435,731,362.00</b>

As per our report of even date attached.

**For Ramanlal G Shah & Co**  
Chartered Accountants  
Firm Registration No.108517W

-Sd-  
**(Dr.Shashank Chaturvedi)**  
Director

-Sd-  
**(Ujjwal Kumar Baruah)**  
Dean

-Sd-  
**(H.K.Sharma)**  
Accounts Officer-II

-Sd-  
**(Sandeep R. Sutaria)**  
Partner  
Membership No. 10228

Place : Gandhinagar  
Dated : May 31, 2017

**INSTITUTE FOR PLASMA RESEARCH****BHAT, GANDHINAGAR – 382 428**

(Sponsored by Dept. of Atomic Energy, Govt. of India, Mumbai)

Registration No. GUJ/88/GANDHINAGAR

**SCHEDULE FORMING PART OF BALANCE SHEET AS AT 31ST MARCH, 2017**

PARTICULARS	2016-17	2015-16
<b><u>SCHEDULE 1 - CORPUS/CAPITAL FUND :</u></b>		
Balance as at the beginning of the year	5,695,034,492.00	4,736,133,072.00
Add : Contribution towards Corpus/Capital Fund	607,137,134.00	1,366,403,745.00
Less : Adjustment to Fixed Assets In-Kind Support from External Agencies	2,624,736.00	-
Adjustment to Unspent Grant	594,003.00	
(Deduct) : Depreciation & Ammortisation charged on Capital Assets for FY 2016-17 transferred to Income & Expenditure A/c	(451,795,596.00)	(387,489,943.00)
Addition/Deduction in Fixed Assets during the year (transfer to/from I & E Account)	607,192.00	151,515,607.00
		(20,012,386.00)
		958,901,416.00
	<b>5,846,550,099.00</b>	<b>5,695,034,488.00</b>
<b><u>SCHEDULE 2 - RESERVE AND SURPLUS :</u></b>		
<b>1. Unspent Grant :</b>		
a) As per last Account	11,919,303,558.00	8,118,335,724.00
<b>Add :</b> Adjustment from Corpus Fund	594,003.00	-
Addition/Deduction during the year (transfer to/from I & E A/c)	83,197,989.00	3,800,967,837.00
Addition/Deduction during the year (transfer to/from Corpus Fund)	-	-
	12,003,095,550.00	11,919,303,561.00
<b>2. Interest earned on Unspent Grant (ITER INDIA FUND):</b>		
As per last Account	784,619,121.00	643,290,378.00
Addition/Deduction during the year (transfer from I & E A/c)	146,642,599.00	931,261,720.00
		141,328,743.00
		784,619,121.00
	<b>12,934,357,270.00</b>	<b>12,703,922,682.00</b>

**INSTITUTE FOR PLASMA RESEARCH**  
**BHAT, GANDHINAGAR – 382 428**  
(Sponsored by Dept. of Atomic Energy, Govt. of India, Mumbai)  
Registration No. GUJ/88/GANDHINAGAR

SCHEDULE FORMING PART OF BALANCE SHEET AS AT 31ST MARCH, 2017			
SCHEDULE-3A - ENDOWMENT FUND			
Dr.Parvez Guzdar Memorial Endowment Fund		2016-17	2015-16
a)	Opening Balance of the fund	619,713	614,895
b)	Additions to the Funds		
	i. Donation/Grants	-	
	ii. Income from Investments made on account of fund	14,714	54,818
	iii. Other additions	-	-
		-	-
<b>TOTAL (a+b)</b>		<b>634,427</b>	<b>669,713</b>
c)	<b>Utilisation/Expenditure towards objectives of the fund</b>		
	i. Revenue Expenditure		
	<i>Dr.Parvez Guzdar Memorial award for Plasma physics</i>	50,000	50,000
	ii. Capital Expenditure	-	
<b>TOTAL ( c )</b>		<b>50,000</b>	<b>50,000</b>
<b>NET BALANCE AS AT THE YEAR END (a+b-c)</b>		<b>584,427</b>	<b>619,713</b>
<b>Represented by</b>			
	Cash And Bank Balance	5,172	55,172
	Investments - FD with SBI	500,000	500,000
	Interest Accrued but not due	129,255	114,541
		<b>634,427</b>	<b>669,713</b>
<b>CURRENT YEAR (2016-17)</b>		(50,000.00)	(50,000.00)

**INSTITUTE FOR PLASMA RESEARCH**  
**BHAT, GANDHINAGAR – 382 428**  
 (Sponsored by Dept. of Atomic Energy, Govt. of India, Mumbai)  
 Registration No. GUJ/88/GANDHINAGAR

**SCHEDULE FORMING PART OF BALANCE SHEET AS AT 31ST MARCH, 2017**

**SCHEDULE 3B - EARMARKED/  
 ENDOWMENT FUNDS:**

	a) Opening Balance of the fund	b) Additions to the Funds	TOTAL (a+b)	e) Utilisation/ Expenditure towards objectives of funds	NET BALANCE AS AT 31ST MARCH, 2017 (a+b-c)	NET BALANCE AS AT 31ST MARCH, 2016
<b>FUND-WISE BREAK UP</b>						
<b>Earmarked Fund</b>						
1 9981 Plasma Processing Fund	27,443,277.00	-	27,443,277.00	-	27,443,277.00	27,443,277.00
1 ITER Iter India Fund - Surplus On Task	328,358,440.00	-	328,358,440.00	-	328,358,440.00	328,358,440.00
<b>Sub Total (a)</b>	<b>355,801,717.00</b>	<b>-</b>	<b>355,801,717.00</b>	<b>-</b>	<b>355,801,717.00</b>	<b>355,801,717.00</b>
<b>Sponsored Projects</b>						
1 9109 TIFAC - EMF	320,782.00	-	320,782.00	-	320,782.00	320,782.00
2 9204 DST - DADD	96,097.00	-	96,097.00	-	96,097.00	96,097.00
3 9213 SPACE-DEBRIS Research	822,815.00	-	822,815.00	587,944.00	234,871.00	822,815.00
4 9216 DST-INSPIRE	591,730.00	48,045.00	639,775.00	10,645.00	629,130.00	591,730.00
5 9217 IPR-CITE-GoG	11,579,553.00	-	11,579,553.00	7,455,177.00	4,124,376.00	11,579,553.00
6 9106 BRNS - EPIA - AD	38,876.00	-	38,876.00	-	38,876.00	38,876.00
7 9331 LPSC THUSTER	4,254,168.00	-	4,254,168.00	3,930,358.00	323,810.00	4,254,168.00
8 9356 DST-NCSTC	-	3,300,000.00	3,300,000.00	-	3,300,000.00	-
9 9222 BRNS-SRC-OIA-SP	2,774,000.00	-	2,774,000.00	666,083.00	2,107,917.00	2,774,000.00
10 9223 EC-19	612,983.00	682,459.00	1,295,442.00	1,295,442.00	-	612,983.00
11 9308 FCIPT-SPIX-II	2,225,181.00	-	2,225,181.00	282,238.00	1,942,943.00	2,225,181.00
12 9309 FCIPT-DU-CDPS	304,502.00	-	304,502.00	193,157.00	111,345.00	304,502.00
13 9310 FCIPT-DU-PPNS	593,587.00	-	593,587.00	78,540.00	515,047.00	593,587.00
14 9311 FCIPT-DU-WGPS	1,008,254.00	-	1,008,254.00	191,333.00	816,921.00	1,008,254.00
15 9312 FCIPT-DU-SEPS	1,513,823.00	-	1,513,823.00	111,734.00	1,402,089.00	1,513,823.00
16 9320 FCIPT-EXCEL	286,444.00	-	286,444.00	92,946.00	193,498.00	286,444.00
17 9357 FCIPT-AAU-DRD	-	780,000.00	780,000.00	-	780,000.00	-
18 9352 FCIPT-IISUPNS	-	3,750,000.00	3,750,000.00	14,839.00	3,735,161.00	-
19 9330 DST FAST TRACK YOUNG SCIENTIS	14,515.00	-	14,515.00	69,139.00	(54,624.00)	14,515.00
20 9335 FCIPT MOEF	361,582.00	-	361,582.00	-	361,582.00	361,582.00
21 9336 FCIPT DST SIKKIM	560,000.00	-	560,000.00	-	560,000.00	560,000.00
22 9337 FCIPT-CSMGR-MoU	1,269,551.00	-	1,269,551.00	217,971.00	1,051,580.00	1,269,551.00
23 9339 VSSC-MoU-IPR	203,483.00	-	203,483.00	71,500.00	131,983.00	203,483.00
24 9340 FCIPT-IIT-Indore	201,415.00	-	201,415.00	-	201,415.00	201,415.00
25 9341 DST-CSIR-CGRI KOLKATA	301,633.00	-	301,633.00	83,844.00	217,789.00	301,633.00
26 9344 FCIPT-DST-ODD	3,897,991.00	394,000.00	4,291,991.00	2,002,294.00	2,289,697.00	3,897,991.00
27 9345 FCIPT-DST-RAD	1,128,511.00	-	1,128,511.00	762,378.00	366,133.00	1,128,511.00

## INSTITUTE FOR PLASMA RESEARCH

### BHAT, GANDHINAGAR – 382 428

(Sponsored by Dept. of Atomic Energy, Govt. of India, Mumbai)

Registration No. GUJ/88/GANDHINAGAR

#### SCHEDULE FORMING PART OF BALANCE SHEET AS AT 31ST MARCH, 2017

#### SCHEDULE 3B - EARMARKED/ ENDOWMENT FUNDS:

	a) Opening Balance of the fund	b) Additions to the Funds	TOTAL (a+b)	c) Utilisation/ Expenditure towards objectives of funds	NET BALANCE AS AT 31ST MARCH, 2017 (a+b-c)	NET BALANCE AS AT 31ST MARCH, 2016
35	9224 INSA Senior Scientist Position	458,467.00	458,467.00	8,627.00	449,840.00	-
36	9225 VEDA-2016	-	450,500.00	4,897.00	445,603.00	-
37	9342 DST-UKIER	(250,887.00)	1,100,000.00	665,587.00	183,526.00	(250,887.00)
38	9068 F.C.I.P.T. - IGCAR - EPA	(2,173,590.00)	2,173,590.00	-	-	(2,173,590.00)
39	9215 DST-WOSA	(132,325.00)	700,000.00	566,290.00	1,385.00	(132,325.00)
40	ITER IO-SA-IWSMDDDC	624,990.00	-	624,990.00	624,990.00	624,990.00
41	ITER IO-SA-RHC	1,021,832.00	-	1,021,832.00	1,021,832.00	1,021,832.00
42	ITER IO-SA-ICHDCIPSC	3,674,762.00	4,387,252.00	-	8,062,014.00	3,674,762.00
43	ITER IO-SA-QCS	3,072,381.00	2,207,453.00	-	5,279,834.00	3,072,381.00
44	ITER UGC-DAE-CSR	45,000.00	-	-	45,000.00	45,000.00
	<b>Sub Total (b)</b>	<b>61,760,831.00</b>	<b>26,355,584.00</b>	<b>25,191,034.00</b>	<b>62,925,381.00</b>	<b>61,760,831.00</b>
1	9081 F.C.I.P.T. - RHVPS	(14,952,573.00)	-	4,164,932.00	(19,117,505.00)	(14,952,573.00)
2	9214 DST-YOS Professor PKK	(1,376,113.00)	3,500,000.00	2,158,492.00	(34,605.00)	(1,376,113.00)
3	9332 DST CZTS SOLAR	(259,671.00)	948,034.00	688,363.00	-	(259,671.00)
4	9334 FCIPT-DST INT ITALY	(357,849.00)	-	-	(357,849.00)	(357,849.00)
5	9343 DST-PKK-GITA	(510,013.00)	694,600.00	502,312.00	(317,725.00)	(510,013.00)
6	9351 33rd DAE Safety & Occupational Meet	-	1,969,000.00	2,052,113.00	(83,113.00)	-
7	9354 FEC-2018	(820,592.00)	-	2,432,149.00	(820,592.00)	-
8	9069 F.C.I.P.T. - DST - UP	-	-	-	-	-
9	9085 F.C.I.P.T. - MNIT	-	-	-	-	-
10	9095 F.C.I.P.T. - DST2	(5,569,425.00)	-	-	(5,569,425.00)	-
11	9110 RRF -TKB	-	-	-	-	-
12	9164 BARC - EED - Project	(4,050,461.00)	19,320.00	570,955.00	(4,020,966.00)	(4,050,461.00)
13	9203 DST - TSG- GYRO- RF	(2,217,752.00)	-	-	(2,217,752.00)	(2,217,752.00)
14	9211 DGFS-PhD	(6,878,056.00)	-	2,360,778.00	(9,238,834.00)	(6,878,056.00)
15	9212 ERC-IPR	(56,044.00)	218,231.00	162,187.00	-	(56,044.00)
16	9306 FCIPT-DST-IPT	(90,254.00)	-	-	(90,254.00)	(90,254.00)
17	ITER IO-SA-D&RHCS (*)	(494,384.00)	-	247,192.00	(741,576.00)	(494,384.00)
18	ITER IO-TA-C22ID18FI (*)	-	-	171,025.00	(171,025.00)	-
19	ITER IO-TA-C26ID12FL-CCWS (*)	-	-	1,570,174.00	(1,570,174.00)	-
	<b>Sub Total (c)</b>	<b>(37,633,187.00)</b>	<b>7,349,185.00</b>	<b>17,080,672.00</b>	<b>(47,364,674.00)</b>	<b>(37,633,187.00)</b>
	<b>BALANCE FOR YEAR 2016-17 (3a + 3b)</b>	<b>379,929,361.00</b>	<b>413,634,130.00</b>	<b>42,271,706.00</b>	<b>371,312,424.00</b>	<b>379,879,361.00</b>

**INSTITUTE FOR PLASMA RESEARCH**  
**BHAT, GANDHINAGAR – 382 428**

(Sponsored by Dept. of Atomic Energy, Govt. of India, Mumbai)  
 Registration No. GUJ/88/GANDHINAGAR

**SCHEDULE FORMING PART OF BALANCE SHEET AS AT 31ST MARCH, 2017**

PARTICULARS	2016-17	2015-16
<b><u>SCHEDULE 4 - CURRENT LIABILITIES AND PROVISIONS:</u></b>		
<b>A. <u>CURRENT LIABILITIES :</u></b>		
1. Sundry Creditors		
a) For Goods	4,592,539.00	12,760,496.00
b) Others	739,793.00	3,630,723.00
2. Other Current Liabilities	-	-
a) Security Deposits	28,463,172.00	11,643,674.00
b) Other Liabilities	2,717,780.00	1,868,648.00
c) Outstanding Expenses	40,558,464.00	18,817,529.00
<b><u>TOTAL (A)</u></b>	<b><u>77,071,748.00</u></b>	<b><u>48,721,070.00</u></b>
<b>B. <u>PROVISIONS</u></b>		
1. Gratuity	306,879,950.00	172,180,667.00
2. Superannuating/Pension	1,855,947,809.00	1,451,007,740.00
3. Accumulated Leave Encashment	295,127,633.00	209,523,389.00
<b><u>TOTAL (B)</u></b>	<b><u>2,457,955,392.00</u></b>	<b><u>1,832,711,796.00</u></b>
<b><u>TOTAL (A+B)</u></b>	<b><u>2,535,027,140.00</u></b>	<b><u>1,881,432,866.00</u></b>

SCHEDULE 5 - FIXED ASSETS											
DESCRIPTION	Rate	GROSS BLOCK			DEPRECIATION			NET BLOCK			
		Cost as at beginning of the year	Addition during the year	Ded./Adj during the year	Cost as at the year end	Up-to beginning of the year	for the year	on deductions/Adj	Total up to the year end	As at the Current year - end	As at the Previous year - end
<b>A. FIXED ASSETS:</b>											
<b>1 LAND:</b>											
a) Freehold	-	-	-	-	-	-	-	-	-	-	-
b) Bhat Land	-	5,675,519.00	-	-	5,675,519.00	-	-	-	5,675,519.00	-	5,675,519.00
c) GDC Land	-	8,352,433.00	-	-	8,352,433.00	-	-	-	8,352,433.00	-	8,352,433.00
<b>2 BUILDINGS:</b>											
a) On Freehold Land	-	-	-	-	-	-	-	-	-	-	-
b) Bhat Main Building/ITER Lab	1.63%	235,784,147.00	6,988,084.00	-	242,772,231.00	67,122,050.00	3,875,033.00	-	70,997,083.00	171,775,146.00	168,662,095.00
c) Guest House/Hovest Building	1.63%	61,023,610.00	-	-	61,023,610.00	5,143,859.00	904,685.00	-	6,138,544.00	54,885,066.00	55,879,751.00
d) Staff quarters	1.63%	2,855,711.00	-	-	2,855,711.00	1,512,810.00	46,548.00	-	1,559,358.00	1,296,353.00	1,342,901.00
e) ICT/PI Building	1.63%	86,664,329.00	-	-	86,664,329.00	5,977,349.00	1,412,629.00	-	7,389,978.00	79,274,351.00	80,686,980.00
f) Additional Building	1.63%	92,941,236.00	-	-	92,941,236.00	2,123,226.00	1,514,358.00	-	3,637,684.00	89,303,582.00	90,871,940.00
g) Laboratory & Auxil. Building	1.63%	11,343,788.00	-	-	11,343,788.00	261,800.00	100,230.00	-	362,030.00	10,981,758.00	11,081,988.00
h) IVAC Building	1.63%	17,623,290.00	-	-	17,623,290.00	422,114.00	287,260.00	-	709,374.00	16,913,916.00	17,201,176.00
i) Pre Feb Building/Approach Road	1.63%	7,266,905.00	306,055.00	-	7,572,960.00	59,225.00	120,945.00	-	180,170.00	7,392,790.00	7,207,680.00
<b>3 PLANT MACHINERY &amp; EQUIPMENTS</b>											
a) Scientific Equipments	4.75%	5,518,617,760.00	301,854,249.00	1,753,039.00	5,818,719,707.00	1,968,871,680.00	302,075,793.00	1,595,448.00	2,269,352,025.00	3,549,366,944.00	3,549,746,079.00
b) Workshop Equipments/CPP Machinery & Equip.	4.75%	7,103,509.00	2,411,556.00	-	9,515,065.00	4,006,993.00	290,597.00	-	4,297,590.00	5,217,475.00	3,096,516.00
c) Workshop Tools (CPP Mechanism Wares)	4.75%	172,093.00	-	-	172,093.00	158,879.00	1,086.00	-	159,965.00	12,128.00	13,214.00
d) FURNITURE, FIXTURES	6.38%	78,055,553.00	479,316.00	184,661.00	78,555,208.00	34,022,843.00	3,937,463.00	175,436.00	37,784,870.00	40,565,338.00	44,032,710.00
e) OFFICE/GEN. EQUIPMENTS	4.75%	47,952,663.00	275,278.00	78,280.00	48,149,661.00	9,957,918.00	2,468,958.00	7,202.00	12,419,674.00	35,729,987.00	37,994,745.00
f) COMPUTER / PERIPHERALS*	16.21%	343,404,094.00	13,337,505.00	5,150,286.00	351,582,823.00	232,182,099.00	25,960,179.00	4,782,582.00	253,359,696.00	98,223,127.00	111,222,915.00
g) ELECTRIC INSTALLATION	4.75%	14,797,813.00	-	-	14,797,813.00	8,039,997.00	406,621.00	-	8,446,618.00	6,351,195.00	6,757,816.00
h) LIBRARY BOOKS/ JOURNALS	4.75%	244,264,242.00	25,326,467.00	-	269,590,709.00	100,481,299.00	10,917,326.00	-	111,398,625.00	158,192,084.00	143,782,943.00
<b>CURRENT YEAR</b>		<b>6,783,899,205.00</b>	<b>350,978,510.00</b>	<b>7,175,266.00</b>	<b>7,127,702,449.00</b>	<b>2,440,344,211.00</b>	<b>354,409,711.00</b>	<b>6,560,668.00</b>	<b>2,788,193,254.00</b>	<b>4,339,509,192.00</b>	<b>4,343,554,991.00</b>
<b>B. INTANGIBLE ASSETS</b>											
1 Computer Softwares*		129,261,080.00	2,553,175.00	-	131,814,255.00	83,639,602.00	13,798,827.00	-	97,438,429.00	34,375,826.00	45,621,478.00
2 Patents		78,400.00	-	-	78,400.00	77,853.00	547.00	-	78,400.00	-	547.00
<b>CURRENT YEAR</b>		<b>129,339,480.00</b>	<b>2,553,175.00</b>	<b>-</b>	<b>131,892,655.00</b>	<b>83,717,455.00</b>	<b>13,799,374.00</b>	<b>-</b>	<b>97,516,829.00</b>	<b>34,375,826.00</b>	<b>45,622,025.00</b>
<b>C. ASSETS AT IGCAR</b>											
1 Building	1.63%	33,567,457.00	-	-	33,567,457.00	1,642,484.00	547,149.00	-	2,189,633.00	31,377,824.00	31,924,973.00
2 Office & General Equipment	4.75%	18,305,614.00	940,502.00	-	19,246,116.00	2,121,401.00	914,190.00	-	3,035,591.00	16,210,525.00	16,184,213.00
3 Computers & Furniture	4.75%	-	167,738.00	-	167,738.00	-	27,190.00	-	27,190.00	140,548.00	-
4 Office Furniture at IGCAR	4.75%	190,757,557.00	13,136,871.00	-	203,894,428.00	19,760,939.00	9,687,067.00	-	29,448,006.00	174,446,422.00	170,996,418.00
5 Scientific Equipments at IGCAR	4.75%	242,630,628.00	14,377,315.00	-	257,007,943.00	23,524,824.00	11,183,965.00	-	5,225,224.00	222,299,154.00	219,105,804.00
<b>CURRENT YEAR</b>		<b>534,351,246.00</b>	<b>14,474,695.00</b>	<b>-</b>	<b>548,826,641.00</b>	<b>44,058,927.00</b>	<b>13,749,370.00</b>	<b>-</b>	<b>30,652,452.00</b>	<b>474,174,189.00</b>	<b>474,174,189.00</b>
<b>D. ASSETS - External Projects</b>											
COMPUTER / PERIPHERALS*	16.21%	2,715,951.00	-	80,704.00	2,635,247.00	2,243,689.00	155,524.00	76,669.00	2,322,544.00	312,703.00	472,262.00
Computer Softwares*	16.67%	453,965.00	-	-	453,965.00	453,965.00	-	-	453,965.00	-	-
OFFICE/GEN. EQUIPMENTS	4.75%	471,106.00	-	-	471,106.00	155,446.00	22,377.00	-	177,823.00	293,283.00	315,660.00
FURNITURE, FIXTURES	6.38%	504,198.00	-	-	504,198.00	415,012.00	18,367.00	-	433,379.00	70,819.00	89,186.00
Scientific Equipments	4.75%	38,429,973.00	-	4,647,036.00	43,077,009.00	10,312,308.00	1,604,307.00	-	9,890,280.00	23,892,657.00	28,117,665.00
<b>CURRENT YEAR</b>		<b>42,575,193.00</b>	<b>-</b>	<b>4,727,740.00</b>	<b>47,302,933.00</b>	<b>13,580,420.00</b>	<b>1,800,573.00</b>	<b>-</b>	<b>13,277,991.00</b>	<b>24,569,462.00</b>	<b>28,994,773.00</b>
<b>D. CAPITAL WORK-IN-PROGRESS</b>											
1		131,053,098.00	224,341,666.00	-	355,394,764.00	2,561,166,910.00	381,193,625.00	-	2,942,212,298.00	4,969,160,317.00	4,768,330,691.00
2		7,329,497,604.00	592,256,666.00	-	7,921,754,270.00	2,329,153,464.00	8,665,672.00	-	2,904,212,298.00	4,969,160,317.00	4,768,330,691.00
<b>PREVIOUS YEAR</b>		<b>6,266,189,858.00</b>	<b>1,227,195,472.00</b>	<b>-</b>	<b>7,493,385,330.00</b>	<b>4,890,320,374.00</b>	<b>3,846,837.00</b>	<b>-</b>	<b>5,095,647.00</b>	<b>9,934,320,634.00</b>	<b>9,736,661,382.00</b>

**INSTITUTE FOR PLASMA RESEARCH**  
**BHAT, GANDHINAGAR – 382 428**  
(Sponsored by Dept. of Atomic Energy, Govt. of India, Mumbai)  
Registration No. GUJ/88/GANDHINAGAR

## SCHEDULE FORMING PART OF BALANCE SHEET AS AT 31ST MARCH, 2017

PARTICULARS	2016-17	2015-16
<b>SCHEDULE 6 - CURRENT ASSETS, LOANS, ADVANCES ETC.</b>		
<b>A. CURRENT ASSETS :</b>		
1. <u>Inventories:</u>		
a) Stores and spares	6,935,185.00	7,422,974.00
2. <u>Sundry Debtors:</u>		
a) Debts outstanding for a period exceeding six months	749,613.00	118,371.00
b) Debts outstanding for a period less than six months	-	1,289,164.00
c) Others	-	-
3. <u>Cash balances in hand</u> (including cheques/drafts and imprest)	5,305.00	45,438.00
4. <u>Bank Balances:</u>		
a) <u>With Scheduled Banks:</u>		
- On Current Accounts		
State Bank of India, IPR.Branch, Ahemdabad A/c.30185519770	26,017,978.00	19,899,920.00
State Bank of India, IPR.Branch, Ahemdabad A/c.30360884053	12,148,256.00	26,084,037.00
State Bank of India, Naroda Branch, Ahemdabad A/c.10159920115	3,619,704.00	658,240.00
State Bank of India, Naroda Branch, Ahemdabad A/c.30360272380	994,228.00	1,235,710.00
- On Deposit Accounts		
State Bank of India	2,989,889,349.00	3,999,812,851.00
- On Savings Accounts		
State Bank of India, A/c No. 30767137485	1,332,870.00	3,860,219.00
State Bank of India, IPR-CPP	26,734,714.00	48,193,069.00
Money Margin With Bank	3,015,000.00	-
State Bank of India, A/c No.33906582576	70,683.00	-
State Bank of India, A/c No.35052592927	396,407.00	29,600.00
<b>TOTAL (A)</b>	<b>3,071,909,292.00</b>	<b>4,108,649,593.00</b>
<b>B. LOANS, ADVANCES AND OTHER ASSETS :</b>		
1. <u>Loans:</u>		
a) Staff		
House Building Advance (Including accrued interest)	20,414,707.00	22,605,781.00
Computer Advance (Including accrued interest)	8,123,369.00	8,849,566.00
Vehicle Advance (Including accrued interest)	3,565,296.00	3,951,047.00
2. <u>Advances and amounts recoverable in cash or in kind or for value to be received:</u>		
a) Advances to Non Govt. Contractors & Suppliers (Including adv. for Capital Works)	8,385,924,798.00	6,871,624,606.00
b) Advances to Govt.Institutions/Organisations (Refer Note 5 of Schedule-14)	696,511,105.00	1,052,087,936.00
c) Deposit with Government Authorities	13,751,412.00	11,778,980.00
d) Deposit with Others	9,878,643.00	11,831,994.00
e) TDS Receivable	1,930,067.00	2,024,291.00
f) Patents Applied for	133,140.00	133,140.00
g) Advance for Travelling Expenses	18,896,079.00	30,464,022.00
h) General Advance	603,598.00	865,668.00
i) Festival Advance	23,850.00	47,700.00
j) LTC Advance	329,634.00	1,655,398.00
k) Medical Recovery	14,607.00	-
l) Telephone recovery	-	-
m) Cafeteria recovery	-	-
n) CPP-NPS	-	-
o) Income due but not received	34,098.00	56,000.00
p) Prepaid Expenses	1,368,653.00	1,539,310.00
p) ITER-India/IPR in CPP Books	-	-
3. <u>Income Accrued:</u>		
a) On Bank Fixed Deposits	21,344,180.00	25,505,594.00
<b>TOTAL (B)</b>	<b>9,182,847,236.00</b>	<b>8,045,021,033.00</b>
<b>TOTAL (A+B)</b>	<b>12,254,756,528.00</b>	<b>12,153,670,626.00</b>

**INSTITUTE FOR PLASMA RESEARCH**  
**BHAT, GANDHINAGAR – 382 428**  
(Sponsored by Dept. of Atomic Energy, Govt. of India, Mumbai)  
Registration No. GUJ/88/GANDHINAGAR

**SCHEDULE FORMING PART OF INCOME & EXPENDITURE FOR THE YEAR ENDED 31ST MARCH, 2017**

PARTICULARS	2016-17	2015-16
<b><u>SCHEDULE 7 - GRANTS/SUBSIDIES :</u></b>		
(Irrevocable Grants & Subsidies Received)		
1) Central Government (Dept. of Atomic Energy, Govt. of India)	5,121,902,000	7,998,388,000
1) In-Kind Support from External Agencies	-	42,575,193
<b><u>TOTAL</u></b>	<b>5,121,902,000.00</b>	<b>8,040,963,193.00</b>
<b><u>SCHEDULE 8 - INTEREST EARNED :</u></b>		
1) On Term Deposits & Savings Deposits:		
a) With Scheduled Banks- State bank of India	263,739,525	190,680,785
2) On Loans:		
a) Employees/Staff		
- On Vehicle Advance	176,952	208,762
- On Computer Advance	254,405	367,812
- On House Building Advance	810,888	785,114
3) Interest on TDS refund	42,719	129,711
<b><u>TOTAL</u></b>	<b>265,024,489.00</b>	<b>192,172,184.00</b>
<b><u>SCHEDULE 9 - OTHER INCOME :</u></b>		
1) Miscellaneous Income	5,340,129	4,371,020
2) Rent	177,888	451,239
3) Royalty & Technology Transfer Fee Income	4,148,300	307,282
4) Other receipts for Facility utilisation	1,053,473	1,852,178
	-	-
<b><u>TOTAL</u></b>	<b>10,719,790.00</b>	<b>6,981,719.00</b>

**INSTITUTE FOR PLASMA RESEARCH****BHAT, GANDHINAGAR – 382 428**

(Sponsored by Dept. of Atomic Energy, Govt. of India, Mumbai)

Registration No. GUJ/88/GANDHINAGAR

**SCHEDULE FORMING PART OF INCOME & EXPENDITURE FOR THE YEAR ENDED 31ST MARCH, 2017**

<b>PARTICULARS</b>	<b>2016-17</b>	<b>2015-16</b>
<b>SCHEDULE 10 - ESTABLISHMENT EXPENSES :</b>		
a) Salaries and Wages	418,709,751.00	318,626,828.00
b) Allowances and Bonus	548,399,016.00	482,601,237.00
c) Contribution to Provident Fund (Including NPS Contribution)	30,129,990.00	22,428,885.00
d) Staff Welfare Expenses	1,392,280.00	1,182,821.00
e) Expenses on Employees' Retirement and Terminal Benefits	578,148,270.00	210,963,705.00
f) NPS charges	109,380.00	156,212.00
Less: PF Contribution Receipt for PF Trust on Option change CPF to GPF	(2,605,692.00)	(4,533,778.00)
<b>TOTAL</b>	<b>1,574,282,995.00</b>	<b>1,031,425,910.00</b>

<b>SCHEDULE 11 - OTHER ADMINISTRATIVE EXPENSES ETC. :</b>		
a) Purchases- Consumable Stores & Spares	198,937,066.00	233,520,983.00
b) Electricity and Power	107,059,550.00	111,904,287.00
c) Repairs and Maintenance	114,768,124.00	103,837,653.00
d) Rent, Rates and taxes	39,124,861.00	33,344,428.00
e) Transport Hire Charges	28,859,515.00	35,241,001.00
f) Postage & Telegraph	826,951.00	892,261.00
g) Telephone and Trunk	6,480,391.00	6,772,059.00
h) Printing and Stationary	2,577,424.00	1,302,045.00
i) Travelling and conveyance Expenses	17,823,216.00	19,989,212.00
j) Travelling Expenses-International	54,191,324.00	58,722,840.00
k) Expenses on Seminar/Workshops	5,432,156.00	5,649,149.00
l) Membership	70,414.00	179,943.00
m) Auditors Remuneration - Internal	172,500.00	172,464.00
n) Auditors Remuneration - Statutory	172,500.00	172,500.00
o) Professional/Legal Charges	872,574.00	1,373,438.00
p) Security Expenses	27,336,952.00	25,880,436.00
q) Visiting Scientist Expenses	2,263,460.00	2,296,754.00
r) Advertisement and Publicity	3,660,262.00	3,376,672.00
s) Admin/Office Exp	2,152,159.00	1,960,603.00
t) Expenses on Academic Programmes	2,280,677.00	4,032,354.00
u) Honorarium	2,344,286.00	1,855,443.00
v) Medical Expenses	21,945,278.00	15,333,483.00
w) Bank Charges	3,841,418.00	613,177.00
x) Remuneration & Wages	74,127,454.00	26,683,674.00
y) Canteen Subsidy	4,822,672.00	3,742,782.00
z) Colloborative Research Expenses	318,505,047.00	103,665,560.00
aa) Technical & Professional Consultancy	1,386,096.00	12,453,815.00
ab) TA to Candidate	7,334.00	-
ac) Freight & Cartage Expenses	414,849.00	-
ad) Reimbursement of Exp. To IO	16,507,992.00	40,246,252.00
<b>TOTAL</b>	<b>1,058,964,502.00</b>	<b>855,215,268.00</b>

<b>TOTAL EXPENSES</b>	<b>2,633,247,497.00</b>	<b>1,886,641,178.00</b>
-----------------------	-------------------------	-------------------------

**INSTITUTE FOR PLASMA RESEARCH  
BHAT, GANDHINAGAR – 382 428**

(Sponsored by Dept. of Atomic Energy, Govt. of India, Mumbai)  
Registration No. GUJ/88/GANDHINAGAR

**SCHEDULE FORMING PART OF INCOME & EXPENDITURE FOR THE YEAR ENDED 31ST MARCH, 2017**

PARTICULARS	2016-17	2015-16
<b>SCHEDULE 12 - DEPRECIATION ON FIXED ASSETS:</b>		
a) Main Building/Lab Building	8,250,564.00	5,676,969.00
b) Guest House / Hostel Building	994,685.00	1,054,058.00
c) Staff Quarters Building	46,548.00	46,548.00
d) FCIPT Building	1,412,629.00	1,379,344.00
e) Additional Office Building	1,514,358.00	-
f) HVAC Building/Lab & Aux. Building	100,230.00	4,121,000.00
g) MSH Building	287,260.00	-
h) Scientific Equipments	345,543,394.00	267,776,258.00
i) Workshop Equipments	820,416.00	725,221.00
j) Workshop Tools	22,009.00	22,009.00
k) Furniture & Fixture	5,695,589.00	5,503,344.00
l) Office/General Equipments	3,159,814.00	3,171,396.00
m) Computers/Peripherals	38,665,678.00	32,814,530.00
n) Electric Installations	652,317.00	641,414.00
o) Library Books/Journals	10,994,886.00	10,042,096.00
p) Pre-Fab Building / Approach Road	120,945.00	123,237.00
<b>TOTAL (A)</b>	<b>418,281,322.00</b>	<b>333,097,424.00</b>
<b>AMMORTISATION ON INTANGIBLE ASSETS :</b>		
a) Computer Softwares	20,529,187.00	22,619,544.00
b) Patents	547.00	17,148.00
<b>TOTAL (B)</b>	<b>20,529,734.00</b>	<b>22,636,692.00</b>
<b>ASSETS AT IGCAR</b>		
a) Building	547,149.00	1,642,484.00
b) Office & General Equipment	914,190.00	2,121,401.00
c) Computer & Furniture	27,190.00	-
d) Office Furniture at IGCAR	8,369.00	-
e) Scientific Equipments	9,687,067.00	14,411,522.00
<b>TOTAL (C)</b>	<b>11,183,965.00</b>	<b>18,175,407.00</b>
<b>ASSETS -External Projects</b>		
a) Computer	155,524.00	2,243,689.00
b) Computer Software	-	453,965.00
c) Office Equipment	22,377.00	155,446.00
d) Office Furniture	18,367.00	415,012.00
e) Scientific Equipments	1,604,307.00	10,312,308.00
<b>TOTAL (D)</b>	<b>1,800,575.00</b>	<b>13,580,420.00</b>
<b>TOTAL (A+B)</b>	<b>451,795,596.00</b>	<b>387,489,943.00</b>

**INSTITUTE FOR PLASMA RESEARCH**  
**BHAT, GANDHINAGAR – 382 428**  
 (Sponsored by Dept. of Atomic Energy, Govt. of India, Mumbai)  
 Registration No. GUJ/88/GANDHINAGAR

**SIGNIFICANT ACCOUNTING POLICIES**

**SCHEDULE- 13:**

**1. BASIS FOR PREPARATION OF ACCOUNTS**

The Financial statements are prepared on the historical cost convention, and on accrual method of Accounting, unless otherwise stated and on going concern basis.

**2. INVENTORY VALUATION**

Stores & spares are valued at the weighted average cost.

**3. INVESTMENT**

Investments are valued at cost.

**4. FIXED ASSETS**

Fixed Assets are recorded at cost which includes incidental expenses incurred up to the date of Commissioning of assets, net of liquidated damages/other recoveries prior to /post commissioning of the assets.

b) **Intangible Assets**

i) Softwares are recorded at cost which includes incidental expenses incurred up to the date of Commissioning.

ii) Patents are recorded at legal cost in the year in which granted. Legal cost includes Governemnet fees and lawyer's fees etc., incurred on getting patents.

**5. DEPRECIATION**

i) Depreciation is provided on Straight Line Basis at the following rates:

Sr	Particular	Rate of Depreciation
1	Building	1.63%
2	Plant Machinery & Equipments	4.75%
3	Furniture & Fixtures	6.33%
4	Office / Gen.Equipments	4.75%
5	Computers / Peripherals	16.21%
6	Electric Installation	4.75%
7	Library Books / Journals	4.75%

ii) Asset Costing Rs.5000.00 or less each are fully depreciated.

iii) Depreciation on additions to Assets other than Buildings and Library Books/Journals is provided on prorata basis from the month of addition. Depreciation on additions to Buildings and Library Books/Journals is provided at 50% of the applicable rate.

**6. AMMORTISATION**

i) Computer Softwares are ammortised during the period of six (6) years.

ii) Patents are ammortised during the period of 10 years from the date of application.

**7. GOVERNMENT GRANTS**

Government Grants are accounted for on the basis of the Income Approach on receipt basis. Grants received in respect of Fixed Assets are transferred to the Corpus Fund through the Income & Expenditure Account at the time of acquisition of Fixed Assets.

**8. FOREIGN CURRENCY TRANSACTION**

i) Foreign currency transactions during the year are recorded at rates of exchange prevailing on the date of transactions.

ii) Foreign Currency Assets and Liabilities are not translated into rupees at the rates of exchange prevailing on Balance-Sheet date, since this would have notional impact on unspent grant. Impact of not translation as above is not quantified.

**9. CONTRIBUTIONS TO PROJECTS**

Contributions to collaborative projects are accounted on the basis of the respective project agreements/Project Memorandum of Understanding. Further accounting for utilization of contribution given for collaborative projects is done on the basis of information regarding utilization received from partner organization.

**INSTITUTE FOR PLASMA RESEARCH**  
**BHAT, GANDHINAGAR – 382 428**  
(Sponsored by Dept. of Atomic Energy, Govt. of India, Mumbai)  
Registration No. GUJ/88/GANDHINAGAR

**10. EXTERNALLY FUNDED PROJECTS**

Receipts & utilization for Externally Funded Projects are being accounted in a specific project account. On closure, surplus/deficit is being transferred to Plasma Processing Fund.

**11. INTEREST EARNED ON PROJECT FUNDS**

Interest earned on the deposits made out of unspent grant and other funds of ITER India is being transferred to ITER-India Fund.

**12. RESEARCH & DEVELOPMENT**

Revenue expenditure on research and development is charged against the grant of the year in which it incurred, Capital expenditure on research and development is shown as an addition to fixed assets. Expenditure on research and development resulting into tangible asset is accounted as fixed asset or intangible assets as the case may be.

**13 RETIREMENT BENEFITS**

Liability for all Retirement benefits like Pension, Gratuity, Leave Encashment are accounted for on actuarial valuation basis.

As per our report of even date attached.

Institute for Plasma Research  
Bhat, Gandhinagar

**For Ramanlal G Shah & Co.,**  
Chartered Accountants  
Firm Registration No.108517W

-Sd-  
(Dr. Shashank Chaturvedi)  
Director

-Sd-  
(Ujjwal Kumar Baruah)  
Dean

-Sd-  
(H.K.Sharma)  
Accounts Officer-II

-Sd-  
(Sandeep R. Sutaria)  
Partner  
Membership No. 10228

Place : Gandhinagar  
Dated : May 31, 2017

**INSTITUTE FOR PLASMA RESEARCH**  
**BHAT, GANDHINAGAR – 382 428**  
 (Sponsored by Dept. of Atomic Energy, Govt. of India, Mumbai)  
 Registration No. GUJ/88/GANDHINAGAR

**NOTES TO THE ACCOUNTS**

**SCHEDULE- 14:**

- 1 a Hitherto, as per rules of ITER India Empowered Board, separate set of accounts & records were to be maintained and separate Audited Statement of Accounts were to be presented for the ITER-India Project w.e.f. April 1,2008. However in accordance with Department of Atomic Energy directive vide their letter No.18/1/2010-R&D-II/9309 Dated October 5,2010, Audited Statements of Accounts for ITER-India Project are to be presented on branch accounting concept.

**2 CONTINGENT LIABILITIES :**

- (i) Contingent Liabilities in respect of claims against the IPR not acknowledged as debts Rs.--NIL-- (Previous year - Rs.NIL).
- (ii) Guarantees and Letter of Credits given by Bank on behalf of the Institute for Plasma Research is Rs.29484.61 Lakhs ( Previous Year Rs. 39382.80 Lakhs).

**3 CAPITAL COMMITMENTS**

Estimated value of Contracts remaining to be executed on Capital Account and not provided for Rs. 1,86,521.98 Lakhs (Previous Year Rs. 2,15,488.14 Lakhs).

**4 DEPRECIATION**

Depreciation for the year 2016- 2017 Rs.45,17,88,190.00 (Previous Year Rs. 38,74,89,943.00) has been debited to the Income & Expenditure Account and the like amount has been transferred from the Corpus Fund to the Income & Expenditure Account

**5 ACCOUNTING OF PROJECT ASSETS**

Fixed Assets set out in the Schedule-5 do not include Scientific Equipment of Rs.2,97,70,540.00 (Previous Year Rs. 74,76,679.00 as on 31.03.2017 purchased out of funds of closed sponsored projects as on 31.03.2017, held and used by Institute, as Project sanctions include stipulations that all such assets purchased out of the project funds will remain the property of the sponsors.

**6 FOREIGN CURRENCY TRANSACTION**

i) <u>Value of Imports Calculated on C.I.F. Basis :</u>	<b>2016-17</b>	<b>2015-16</b>
- Capital Goods	573,674,017.00	801,418,943.00
- Consumables & Spares	95,816,922.00	80,060,657.00
ii) <u>Expenditure in foreign currency :</u>		
- Travel	40,523,271.00	45,690,360.00
- Cash Contribution to ITER-Organisation	1,944,763,865.00	1,102,930,409.00
- Technical Consultancy		-
iii) <u>Earnings :</u>		
- Value of Exports on F.O.B. basis	Nil	Nil

- 7 Advance to Govt.Institutions / Organaisation stated in Schedule - 6B.2.b) includes:

a An amount of Rs. 4.46 Crore ( Previous year Rs. 6.26 Crore ) has been paid to Indira Gandhi Centre for Advance Atomic Research for collaborative research on Development of ITER Test Blanket Modules which is pending for adjustment in absence of information regarding its utilisation.

b An amount of Rs.29.27 Crore (Previous year Rs. 53.00 Crore) has been paid to Bhabha Atomic Research Centre for collaborative research on Development of ITER Test Blanket Modules, which is pending for adjustment in absence of information regarding its utilisation.

**INSTITUTE FOR PLASMA RESEARCH**  
**BHAT, GANDHINAGAR – 382 428**  
(Sponsored by Dept. of Atomic Energy, Govt. of India, Mumbai)  
Registration No. GUJ/88/GANDHINAGAR

- 8 a One reactor for aprox. Rs. 8.00 Lacs (Rupees Eight Lacs) included in present value of Assets is lost. No provision is made for loss, as lower court has decided the case in favour of the Institute and the matter is pending before Hon.High Court of Gujarat.
- b Since 2011, Iter-India has given advances to contractor aggregating to Rs. 4,84,06,387/- for implementation of SAP software. These advances has been shown under Current Assets (Advances to Non-Govt. Contractors). Last Year a committee consisting of Senior Scientists had been formed by Project Director - Iter-India, to review implementation status of SAP and closure of contracts related thereto. Accounting treatment of above advances will be decided based on and as directed by the final decision of the committee as aforesaid. The decision of the Committee is pending.
- 9 No Insurance Policy is taken for the Movable & Immovable assets as per the usual practice.
- 10 Balances of Suppliers/Contractors are subject to confirmations & adjustment, if any.
- 11 Previous year's figures have been regrouped wherever necessary to correspond with the current year's figures.

As per our report of even date attached.

**Institute for Plasma Research**  
**Bhat, Gandhinagar**

**For Ramanlal G Shah & Co.,**  
Chartered Accountants  
Firm Registration No.108517W

-Sd-  
**(Dr.Shashank Chaturvedi)**  
Director

-Sd-  
**(Ujjwal Kumar Baruah)**  
Dean

-Sd-  
**(H.K.Sharma)**  
Accounts Officer-II

-Sd-  
**(Sandeep R. Sutaria)**  
Partner  
Membership No. 10228

Place : Gandhinagar  
Dated : May 31, 2017

Audited Statements of Accounts  
as on 31st March 2017  
**INSTITUTE FOR PLASMA RESEARCH**

Employees Provident Fund

## IPR EMPLOYEE'S PROVIDENT FUND.

BALANCE SHEET AS AT 31<sup>ST</sup> MARCH, 2017

2015-16	CORPUS/CAPITAL FUND AND LIABILITIES		2016-17
	<b>MEMBERS PF SUBSCRIPTION :</b>		
	(Net of Loans & including Interest on Subscription)		
226,547,154.92		Balance as on 1st April 2016	257,549,029.34
43,780,858.00		Addition During the year	68,775,796.00
12,778,983.58	257,549,029.34	Less : Debit During the year	12,514,786.04
			313,810,039.30
	<b>INSTITUTE'S PF CONTRIBUTION :</b>		
	(Including Interest )		
13,646,544.15		Balance as on 1st April 2016	9,806,281.15
1,552,032.00		Addition during the year	1,570,168.00
5,392,295.00	9,806,281.15	Less : Debits during the year	2,605,492.00
			8,770,957.15
	<b>LAPSE &amp; FORFEITURE A/c</b>		
1,642,343.49		Balance as on 1st April 2016	1,642,343.49
-	1,642,343.49	Addition during the year	-
			1,642,343.49
	<b>CURRENT LIABILITIES :</b>		
95,862.00	95,862.00	Sundry Credit Balances.	145,522.00
			145,522.00
	<b>INCOME &amp; EXPENDITURE A/c</b>		
35,322,535.17		Openig Balance	38,809,432.17
3,486,897.00	38,809,432.17	Add/Less : Transfer from Income & Expenditure A/c	4,952,961.05
			43,762,393.22
	307,902,948.15	<b>TOTAL</b>	368,131,255.16
	<b>ASSETS</b>		
272,747,107.00		FIXED DEPOSIT with State Bank Of India / Public Financial Institute.	295,807,607.00
	3,311,917.02	S/B A/c with : State Bank Of India	17,262,323.03
			313,069,930.03
	31,493,937.13	Interest accrued but not due on Fixed Deposits with a Scheduled Bank / Public Financial Institute.	54,818,999.13
			54,818,999.13
	<b>Income-Tax Deducted at source :</b>		
349,987.00		Balance as on 1st April 2016	349,987.00
-		Addition during the year	94,030.00
0.00	349,987.00	Less : Refund Received	201,691.00
			242,326.00
	307,902,948.15	<b>Total</b>	368,131,255.16

Note :1) Loan transactions are merged with members subscription accounts. **Rs. 56,01,865/-** were given during the year ended as on 31st March 2017, **Rs.68,66,446/-** are outstanding in loan accounts.

2) Balance of Lapse & Forfiture account is subject to reconciliation & adjustment, if any.

Examined and Found correct.  
**For Ramanlal G Shah & Co**  
Chartered Accountants  
Firm Registration No.108517W

-Sd-  
**(Ujjwal K Baruah)**  
Engineer-H  
Chairman

-Sd-  
**(H.K.Sharma)**  
Accounts Officer-II. IPR  
Member

-Sd-  
**(Sandeep R. Sutaria)**  
Partner  
Membership No.10228

Place : Bhat, Gandhinagar  
Dated : May 31, 2017

**IPR EMPLOYEE'S PROVIDENT FUND.****INCOME AND EXPENDITURE ACCOUNT FOR THE PERIOD  
ENDED ON 31<sup>ST</sup> MARCH, 2017**

2015-16	<u>INCOME</u>	2016-17
141,776.00	Interest On Savings Bank Account & Others	169,929.05
24,236,816.00	Interest On Fixed Deposit	26,559,544.00
-	Interest on TDS refund	35,299.00
24,378,592.00	<b>TOTAL</b>	26,764,772.05
<u>EXPENDITURE</u>		
20,163,199.00	Interest on Members Subscription	21,257,529.00
728,496.00	Interest on Institute's Contribution	553,983.00
-	Bank Charges	299.00
3,486,897.00	Excess of Income over Expenditure transferred to Balance Sheet	4,952,961.05
24,378,592.00	<b>TOTAL</b>	26,764,772.05

Examined and Found correct.  
**For Ramanlal G Shah & Co**  
Chartered Accountants  
Firm Registration No.108517W

-Sd-  
**(Ujjwal K Baruah)**  
Engineer-H  
Chairman

-Sd-  
**(H.K.Sharma)**  
Accounts Officer-II. IPR  
Member

-Sd-  
**(Sandeep R.Sutaria)**  
Partner  
Membership No.10228

Place : Bhat, Gandhinagar  
Dated : May 31, 2017