

ANNUAL REPORT

2011-2012



प्लाज़्मा अनुसंधान संस्थान

Institute for **Plasma Research**

Bhat, Gandhinagar 382428

GOVERNING COUNCIL

- | | |
|--------------------------|----------------------|
| 1) Dr. S. Banerjee | Chairman |
| 2) Dr. P.K. Kaw | Member |
| 3) Dr. R.K. Sinha | Member |
| 4) Dr Amit Roy | Member |
| 5) Dr. J. N. Goswami | Member |
| 6) Dr. Siraj Hasan | Member |
| 7) Ms Revathy Iyer | Member |
| 8) Shri .V. R. Sadasivam | Member |
| 9) Mrs. Jayanti S. Ravi | Member |
| 10) Shri Sanjay Lal Bhai | Member |
| 11) Shri P. K. Atrey | Non-Member Secretary |

EXECUTIVE SUMMARY

The financial year 2011-12 marked the end of the 11th five-year plan. As we enter into the more important 12th plan period, I have great pleasure in summarizing our achievements in the last year of 11th plan. In summary, we have initiated some new projects in the 11th plan and made significant progress in each of those projects. Likewise, we have operated Aditya tokamak and carried out experiments that are relevant to our next generation SST-1 tokamak that is under refurbishment. During the last year, we have completed the assembly of refurbished SST-1 tokamak. We have also continued to work on Indian contribution to ITER tokamak, and at the same time, promote under BRFST program those science and technology initiatives that are relevant to developing thermonuclear fusion capability in the country.

Aditya tokamak is our workhorse for testing SST-1 sub-systems and for carrying out experiments relevant to SST-1 tokamak. For example, the challenge of operating SST-1 tokamak at low loop voltage has been addressed on Aditya tokamak. Experiments on Aditya tokamak have indicated that it is possible to operate tokamak at low loop voltage provided it is coupled with ICRF pre-ionisation. Several SST-1 relevant experiments have been conducted on this tokamak, for example, reduction of runaway electrons by using a pulsed local vertical field etc.

The SST-1 refurbishment has made rapid and significant progresses. A series of test experiments have been conducted in previous years for validating the suitability of SST-1 components and for establishing methodologies and protocols of SST-1 assembly. The SST-1 assembly has now been completed and validation trials are being conducted for establishing that assembled SST-1 has the required capability.

In the 11th plan period, we had taken up challenge of developing several fusion relevant technologies, namely, development of Nb₃Sn and NbTi superconductor strands and fabrication technology of large superconductor magnets, TBM related R&D activities, development of high capacity cryopump and fabrication technology of prototype vacuum vessel, development of technology for divertor fabrication, and development of negative ion beam. Significant progress has been made in each of these projects. For example, superconductors of 30 kA current capacity has been developed with the help from Atomic Fuels Division (AFD) at Bhabha Atomic Research Center (BARC) and Institute for Minerals and Materials Technology (IMMT). The winding machine for fabricating large magnets has been set up at IPR. In TBM related R&D activities, Reduced Activation Ferritic Martensitic Steel (RAFMS), which will be used as structural material of the TBM, has been developed at MIDHANI with help from IPR and IGCAR, a lead-lithium buoyancy loop experiment has been set up at IPR and significant quantity of lithium titanate ceramic pebbles has been produced at BARC. Similarly, progress is made towards fabrication of large cryopump components by developing, along with our industry partner, quilted cryo panels in different geometry and high sorption Activated Carbon Fabric (ACF) and other sorbent materials. In prototype divertor project, a high heat flux test facility, using electron beam as heat source is being set up for testing materials at high temperature. With the already installed RF based plasma source of the negative ion beam system, it was mandated to incorporate the accelerator into the system with upgraded gas feed system, data acquisition and

control system and RF matching unit. These activities have been completed and the negative beam system will be tested soon after the complete integration.

For the fundamental plasma sciences, basic experiments are being continued on various fronts. The LVPD experiments have reported the first laboratory observation of ETG turbulence. Other ongoing experiments are fluctuations-driven flow studies on BETA device, parametric dependence of plasma nitriding, studies on current free double layers, characterization of laser induced barium plasma, and studies of magnetized plasma-surface interaction. In addition, setting up of some other experimental devices, for example, System for Microwave Plasma Experiments (SYMPLE), Plasma Wake-Field Acceleration Experiment (PWFA), dusty plasma experiments, Multi-Cusp Plasma Experiment and Laser Blow-off Experiment have reached final stages of completion.

The theoretical and computational activities have reported progress in basic physics studies, laser-plasma interaction, dusty plasma studies, global gyro-kinetic studies, molecular dynamics simulations etc. With the mandate to develop plasma applications for industries, the FCIPT is catering to a variety of industries ranging from spacecraft plasma interaction simulations, to plasma treatment of angora wool and other fabrics.

In order to supply Indian commitments to ITER, many new procurement arrangements have been signed, apart from developing new processes and procedures to fulfill these commitments. One of the examples of how BRFST under National Fusion Program is helping to develop new technology is the quilted cryopanel both for SST-1 tokamak and the cryopump programme. Similarly, the programme at CPP-IPR is now being tailored to suit and contribute to the main mandate of IPR.

Director,
IPR.

CONTENTS

A. Summary of scientific and technical programme	
A.1. Fusion plasma Experiments	
A.1.1. Aditya Tokamak	
A.1.1.1. Status of the Device	1
A.1.1.2. Diagnostics Developments	1
A.1.1.3. Heating and Current drive systems	3
A.1.1.4. Experiments and Results	4
A.1.2. Superconducting Steady state Tokamak – 1	
A.1.2.1. Status of the Device	7
A.1.2.2. Diagnostics developments	9
A.1.2.3. Heating and Current drive Systems	10
A.2. Fusion Technologies Development under XI th Five Year Plan	
A.2.1. Fusion Relevant Prototype Magnet Development	13
A.2.2. Prototype Divertor Cassette Development for Fusion Grade Tokamaks	14
A.2.3. Test Blanket Module	17
A.2.4. Negative Ion Beam Source	18
A.3. Basic Experiments	
A.3.1. Large Volume Plasma Device(LVPD)	22
A.3.2. Basic Experiments in Toroidal Assembly(BETA)	26
A.3.3. Interaction of Low Energy Ion and Neutral Beams with Surfaces	26
A.3.4. System for Microwave Plasma Experiments (SYMPLE)	27
A.3.5. Plasma Wake-Field Acceleration Experiment (PWFA)	29
A.3.6. Experimental Study of Non-linear Plasma Oscillations	29
A.3.7. Experiments on Dusty Plasma	30
A.3.8. A linear helicon plasma device with controllable magnetic field gradient	31
A.3.9. Multi-cusp Plasma Experiment	31
A.3.10. Laser Blow-Off Experiment	32
A.3.11. Magnetized Beam Plasma Surface Interaction Experiment	33

C o n t d...

A.4. Theoretical, Modeling and Computational Plasma Physics	
A.4.1. Basic Physics Studies	34
A.4.2. Laser Plasma Studies	34
A.4.3. Dusty Plasma Studies	34
A.4.4. Global Gyro-kinetic Studies	34
A.4.5. Molecular Dynamics (MD) Simulations	35
A.4.6. Modelling and Demo Studies	35
B. ACTIVITIES OF OTHER CAMPUSES	
B.1. Facilitation Center for Industrial Plasma Technology (FCIPT) Activities	
B.1.1 Fundamental Plasma Activities In Industrial Plasma Applications	37
B.1.2. Plasma Surface Engineering	38
B.1.3. Plasma Pyrolysis	40
B.1.4. Research, Development and Other Activities	41
B.1.5. Surface Characterization Laboratory Activities	42
B.2. ITER-India	43
B.3. Center of Plasma Physics(CPP-IPR), Guwahati	54
B.4. Board of Research on Fusion Science and Technology (BRFST)	58
C. ACADEMIC PROGRAMME	
C.1. Ph.D. Programme	60
C.2. Summer School Programme	60
D. TECHNICAL SERVICES	
D.1. Engineering Services	
D.1.1. Air conditioning and Water cooling	60
D.1.2. Computer Services	60
D.2. Library Services	61
E. PUBLICATIONS AND PRESENTATIONS	
E.1. Research Reports	62
E.2. Technical Reports	72
E.3. Conference Presentations	74
E.4. Invited talk by IPR staff	86
E.5. Talks by Distinguished visitors at IPR	89
E.6. Colloquia Presented at IPR	90
E.7. Scientific meetings hosted by IPR	91



ANNUAL REPORT

April 1, 2011 to March 31, 2012

Since 1986 the institute has been excelling in plasma physics research with fast growing facilities, trained man power and many fruitful national and international collaborations. Started with small tokamak experiments and basic plasma experiments, the institute has been acquiring expertise in all the relevant scientific and technological requirements for controlled thermonuclear fusion. Through the participation of the country in the International Thermonuclear Experimental Reactor (ITER), the developed technologies are being tested in the international arena. The activities of the Board of Research on Fusion Science and Technology (BRFST) and the Fusion Technology Development Programme under the past and current Five Year Plans are fuelling the required growth. At the same time basic experiments related to immediate plasma technology dissemination to industry through Facilitation Center for Industrial Plasma Technology (FCIPT) forms an integral part of the programme. Now the programme of the Center for Plasma Physics, are also being aligned to the main theme of fusion research

A. SUMMARY OF SCIENTIFIC & TECHNOLOGICAL PROGRAMMES

Scientific programme of the institute can broadly be categorised into five main areas as following: 1) magnetically confined fusion plasma experiments 2) Fusion Technology Developments 3) Basic Experiments 4) Theoretical and Computational Physics and 5) Activities at Other Campuses.

A.1 Fusion Plasma Experiments

A.1.1 Aditya Tokamak

A.1.1.1 Status of the Device

Many experiments have been carried out in Aditya tokamak in last one year of operation mainly aiming at the control and upgradation of the operational parameter window and different preionization techniques. Significant improvement in normal discharge reproducibility as well as successful low loop voltage plasma initiation with different preionization techniques has been achieved. Typical discharges with parameters: plasma current $\sim 70 - 90$ kA; chord averaged electron density $\sim 1 - 2 \times 10^{13} \text{ cm}^{-3}$; central plasma temperature $\sim 350 - 400$ eV and discharge duration of $\sim 80 - 100$ msec with significantly reduced runaway electron generation are achieved regularly. With negative converter operation it has been possible to extend plasma duration upto 250 msec very close to original Aditya design value. Preionization always helps for the successful start-up of tokamak discharge. ICR preionization has been successfully implemented in ADITYA. With the help of ICR preionization it is possible to have a successful start-up at low voltage of ~ 10 V. Radio-frequency preionization at 13.56 MHz has also been successfully tried using parallel rings. Position control with fast feedback pow-

er supply has been carried out. Two set of new coils has been installed to produce a local vertical field to extract the runaway electrons during plasma formation phase as well as the flat-top phase of plasma current. Apart from these, fluctuation suppression experiments with gas puff and electrode bias experiments are carried out.

A.1.1.2 Diagnostic Developments

Neutral Particle Diagnostics : The Time of Flight Neutral Particle Analyzer (TOF-NPA) is an energy analyzer which is used for estimating plasma ion temperature in Tokamak fusion devices. It is based on the principle that the neutrals escaping from the magnetic confinement of the plasma are mechanically chopped and after traversing a certain distance within the flight tube, they fall on the detector. An arrival time distribution profile of neutral flux is obtained (depending upon the initial energy of the neutrals) which facilitates the plasma ion temperature estimation. The shape of the neutral atom emission spectrum is useful as a diagnostic of both the central and edge ion temperature. In addition, neutral atom emission is an important signature of plasma recycling and gas puffing processes which are responsible for maintenance and control of the plasma density. The TOF-NPA mainly consists of a mechanical chopper housing assembly, flight tube, detector housing assembly, electronics for light sensing circuitry (LSC) and signal detection and the data acquisition system (DAQ). Chopper's rotation frequency (round per minute) is the most critical parameter which decides the energy resolution of the system. The following works were done for this diagnostics : (a) The Time of Flight chamber has been tested for its vacuum compatibilities. (b) The vacuum vessel containing the chopper, the drift tube and that enclosing the detector assembly has been tested separately as well as with assembled together. (c) The vacuum levels in the individual components of the fabricated system and also when assembled together was found to be $\sim 2.0\text{E-}08$ mbar after several hours of baking. (d) The Chopper was operated in the

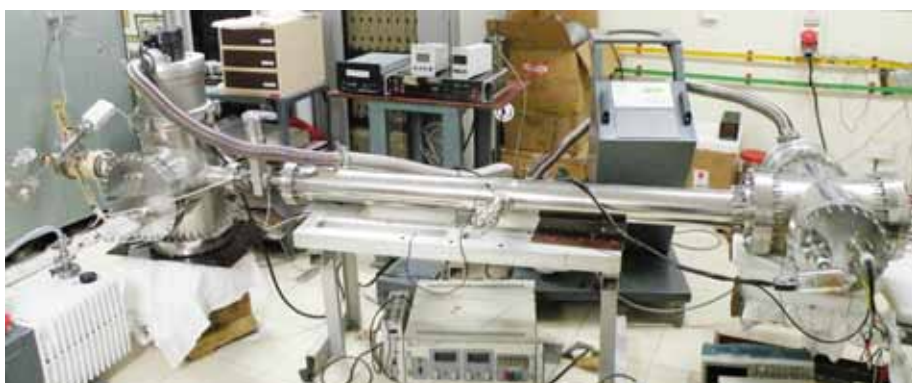

Figure A.1.1.1. The time of flight system assembled with the ion source, chopper and detector for the calibration at CXD lab

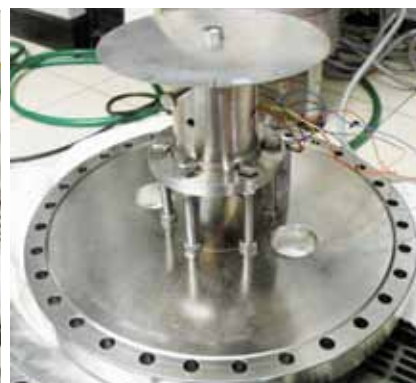

Figure A.1.1.2 The chopper wheel mounted on the 250 CF Flange.

vacuum chamber with different operating voltages [maxm ~ 25 Volts, 5 Amp]. (e) The output of a laser beam was taken out through a silicon photo diode and the variation in the gating time and the full rise to fall time of the chopper-signal was noted for various applied input voltage to the chopper motor. (f) It has been experimentally seen that the chopper motor reaches an RPM of ~ 40K at an applied voltage of just 18 volts, without creating any out gassing or load in the vacuum level of the chamber. (g) The detector assembly [the channeltron operated in continuous mode combined with an I-to-V converter] has to be calibrated with an H⁺ -ion source for 100 to 500 eV of energies.

Infrared Thermography of the ADITYA Limiter : Thermal images of the ADITYA limiter were analyzed and compared with other diagnostics data. Many phenomenon were observed for the plasma limiter interaction namely point of plasma discharge initiation, plasma discharge termination, temporal temperature evolution of the inboard – outboard limiter tiles, erosion of material from the limiter tiles. Time profile of the inboard-outboard limiter temperature shows radial movement of the plasma column and good co-relation were found with radial position data, limiter viewing optical-fibre data. Thermographic frame sequences for the plasma shot# 21655 is shown in A.1.1.3.

Infrared Imaging Video Bolometer for the ADITYA and SST-1 tokamak : Infrared Imaging Video Bolometer (IRVB) is a new techniques and a powerful tool to measure total radiated power loss in wide spectral range (X-rays to Visible). It can provide temporally and spatially resolved (2-D) radiation power loss images from plasma devises. The technique is for the first time being utilized for the medium size tokamak ADITYA. A proposal for the development of IRVB was made

for the tokamak, main objectives for the ADITYA-IRVB are measurement of temporally and 2-D radiated power profile of the tokamak plasma, testing of the IRVB for its functionality, testing of analysis scheme and for quick results, gaining experience before deployment of this new diagnostic scheme on SST-1 machine and estimation of the total radiation power loss from the plasma. A basic simulation code is developed for the IRVB signal estimation and to generate expected IRVB image on detector plane. The IRVB for ADITYA was designed, developed, calibrated, tested for its performance, installed and successfully operated on the ADITYA tokamak. The concept of the IRVB system, simulated image and the initial experimental results from the IRVB are shown in Figure A.1.1.4.

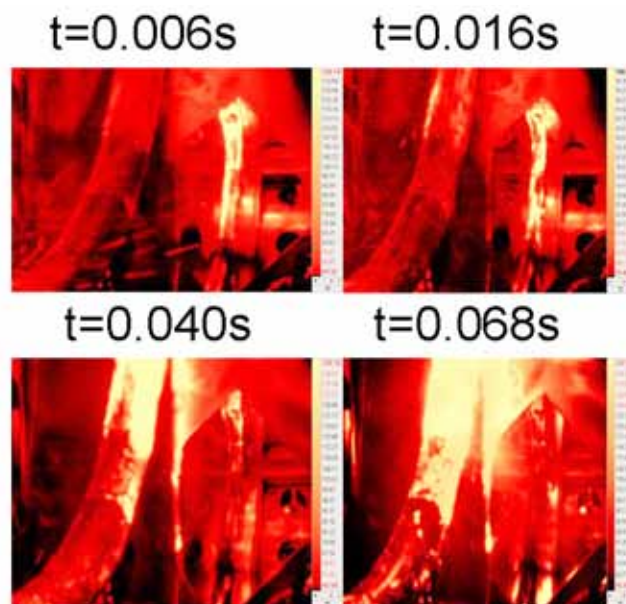

Figure A.1.1.3 Thermographic frame sequences -shot# 21655

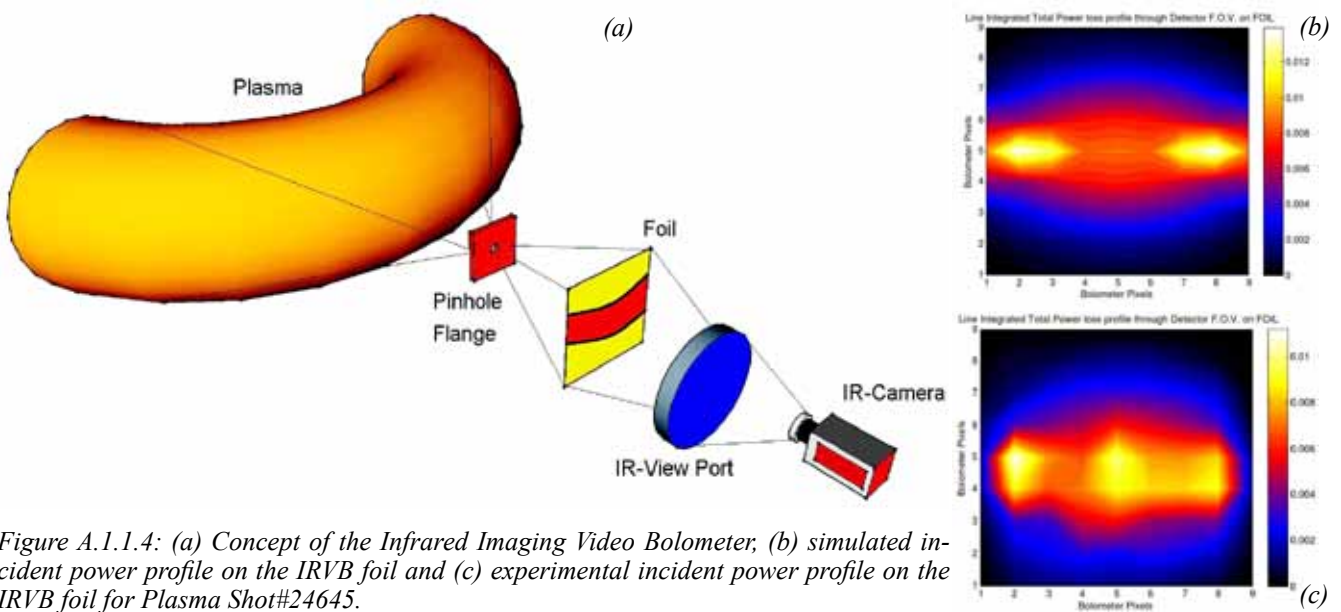

Figure A.1.1.4: (a) Concept of the Infrared Imaging Video Bolometer, (b) simulated incident power profile on the IRVB foil and (c) experimental incident power profile on the IRVB foil for Plasma Shot#24645.

A.1.1.3 Heating and Current Drive Systems

Electron Cyclotron Resonance Heating (ECRH)
42GHz / 0.5MW ECRH system for Tokamak SST-1 and Aditya : The 42GHz-500kW ECRH system would be used in SST-1 for breakdown at fundamental harmonic (1.5T operation) and same system would be used in Aditya at second harmonic at 0.75T operation. The 42GHz ECRH system has been ordered and layout inside the SST-1 hall and in Aditya tokamak is finalized after the discussion with the supplier. The launchers (antenna) design for SST-1 and Aditya are in advance stage. The design of other subsystems (electrical, mechanical, launcher, DAC etc.) are also in advance stage of development for the commissioning of 42GHz ECRH system on Aditya and SST-1.

Lower Hybrid Heating Drive (LHCD)
 To carry out pre-ionization and start-up experiments on ADITYA machine, employing high power electromagnetic waves at 3.7 GHz., the high power klystron system is shifted to ADITYA hall. The layout and planning for the klystron system assembly and commissioning in ADITYA hall is carried out. The klystron, tank and magnets are installed in ADITYA hall. The cooling requirements are generated and cooling connections are made after making necessary modifications in the existing cooling line in ADITYA hall. After completing the high voltage cabling and control cable, connections are established with high voltage power supply. The klystron is conditioned and operated upto 50kV and with the available power, preionization experiments in ADITYA machine is conducted.

Preionization with Ring Antenna and RF power : A set of experiments are conducted in ADITYA machine for plasma preionization, employing rf waves, launched by employing ring antenna. An experimental set-up, employing ring antenna (figure A.1.1.3.1a) and rf system using 13.56 MHz./2.5 kW source is installed and commissioned on ADITYA machine to try out initial experimental trials. Plasma is formed in the entire vessel with coupled power as low as ~20W. With ~200W coupled power, plasma is formed (figure A.1.1.3.1b) over a wide range of pressure (50mTorr to 10⁻⁶Torr) and over wide range of toroidal magnetic field of 200G – 7.5kG. Measurements reveal that plasma density of about ~10¹⁵ m⁻³ is formed with 750W of coupled rf power at a pressure of 2x10⁻⁴ torr.

Ion Cyclotron Resonance Heating (ICRH)
 Pre-ionization experiments were carried out in ICRF range using poloidal type fast wave antenna, and 200 kW RF system at 24.8 MHz frequency which corresponds to the second harmonic resonance layer at the center of the vacuum vessel of tokamak ADITYA at 0.825 T. The diagnostics used are Langmuir probes, visible camera, spectroscopy, soft X-ray and hard X-ray detection techniques, diamagnetic loop and microwave diagnostics like interferometer and reflectometer. The experiments were carried out in different phases to have full understanding and control over current ramp-up. In first phase only RF breakdown is produced at 24.8 MHz using a fast wave antenna without toroidal magnetic field and loop voltage at different RF powers. In second phase, RF plasma is produced in presence of different toroidal magnetic fields varying from 0.825 T to 0.075 T. For 24.8 MHz RF frequen-

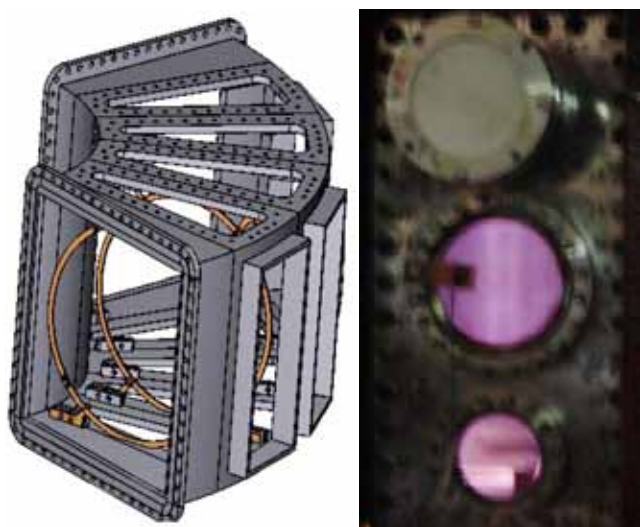

Figure A.1.1.3.1. (a) Schematic of pair of coils inserted in ADITYA machine; (b) Plasma formed with ring antenna

cy, the second harmonic resonance layer lies at the center of the plasma at 0.825 T and when the magnetic field is varied, it goes away from the antenna towards high field side and finally vanishes at ~ 0.5 T inside the vacuum vessel. It is observed that at higher magnetic fields when the resonance layer is present in front of antenna into vacuum vessel, the plasma spreads toroidally all around the vessel but radial spread is mostly limited up to resonance layer. In case of non-resonant plasma, when there is no resonance layer in the plasma volume at the lower magnetic field, the plasma occupies the full volume but the plasma density formed is lower than that of the resonant plasma. Then the experiments are carried out at 0.75 T and the RF power is varied from 20 kW to 120 kW power. Also the pre-ionization is produced at different pressures in the range of 3×10^{-5} Torr to 8.0×10^{-4} Torr. It is observed that plasma density due to pre-ionization is in the range $10^{10}/\text{cc}$ and that of normal plasma after current ramp-up is in the range of $10^{13}/\text{cc}$. It is observed that the pre-ionization density increases with increase in pressure as well as with increase in magnetic field. The CCD cameras are installed at radial and top position at outboard side and following photographs (Figure A.1.1.3.2) show the plasma production under non-resonant and resonant conditions respectively. In third phase, the experiments are carried out with RF power and the full loop voltage of 22 volts. The duration of RF pulse is from -150ms with reference to Ohmic loop voltage starting at 0ms. In this experiment, the over-lapping time of RF power with loop voltage is varied and also the RF power is varied. The adjustment of the vertical field as well as the magnitude, duration and the frequency of the gas puff is done to

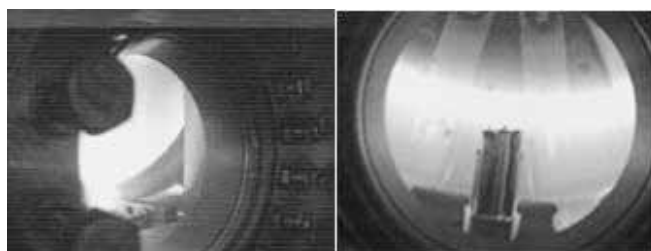

Figure-A.1.1.3.2 Left - radial view (#24054, RF=80 kW, TF=0.45T, $P = 7-8 \times 10^{-5}$ torr). Right - top view (# 24111, RF=70 kW, TF=0.75T, $P=6.0 \times 10^{-5}$ torr)

have normal current build-up of 90 kA plasma current, 90ms duration with electron temperature around 300 eV. In fourth phase the loop voltage of Ohmic transformer is decreased by decreasing the current through the transformer due to which the available volts-sec also decreases. The pre-ionization and current ramp-up experiments are carried out at different loop voltage varying from 22 volts to 8 volts. It was observed that at 8 volts loop voltage without RF, we could get only a few kA current for few ms which was not possible to ramp up. However as soon as RF pre-ionization was produced we could ramp-up the plasma current to have normal discharge (Figure A.1.1.3.3). In fifth phase, the resistors in the ohmic transformer are changed to keep available volt-seconds of Ohmic system constant and the current ramp-up experiments are carried out. However, by changing resistors, we could not save appreciable volts-seconds to have longer discharge because of the fast rise time of the loop voltage. In the last phase the current ramp-up experiments are carried out at 8 volts loop voltage at constant RF power and gas pressure but with a slow rise time to simulate the requirements of steady state tokamak (SST-1) in which the loop voltage decreases as well as gets delayed. In case of slow rise time (~ 3 ms) of the loop voltage, we could ramp-up current successfully to have normal plasma current. It is observed that 3 ms delay in the loop voltage rise time does not affect the current ramp-up. It is expected that the results of the pre-ionization experiments carried out at lower loop voltages with slower loop time will help in carrying out similar experiments on tokamak SST-1.

A.1.1.4 Experiments and Results

Measurement of transport driven plasma flows in scrape-off layer of Aditya tokamak : The plasma flows in the scrape-off layer consists of two components, namely, drift driven and transport driven. The transport driven component can be determined by making flow measurements by reversing directions of plasma current (I_p) and toroidal magnetic fields (BT), and taking average of the measured flow velocity to

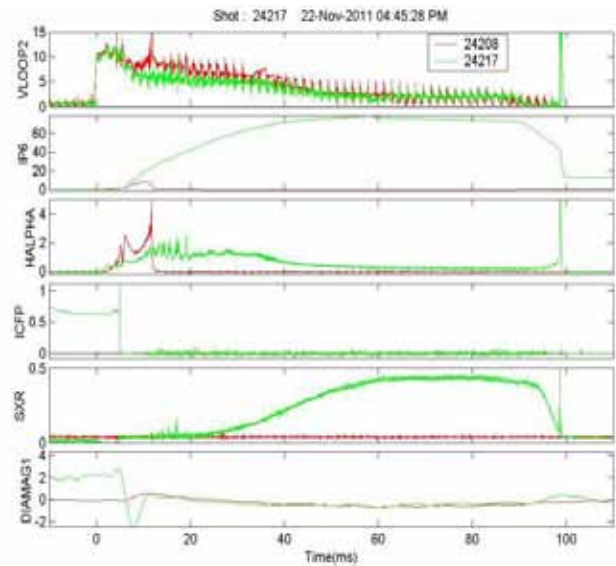
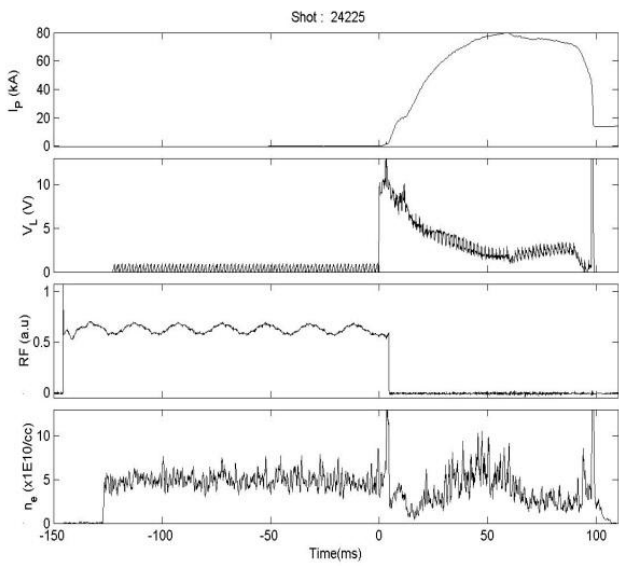

Figure-A.1.1.3.3 Left - time traces of plasma current, applied loop voltage, ICRF pulse and measured density . Right - two similar shots one is with ICRH pre-ionization (green) and other without it (red). The figure clearly shows a normal plasma current ramp up at low loop voltage with ICRH assistance.

these two cases. We have therefore carried out flow measurements by using Mach probes and by reversing directions of both BT and I_p , which allows determination of transport driven components as described above. The flow velocities are measured in units of Mach number (ratio of flow velocity and the local sound speed). The radial profile of measured Mach number is presented in Figure A.1.1.4.1). The grad-B drift is downward when BT is in counter clockwise (CCW) direction and I_p is in the clockwise (CW) as seen from top of the tokamak. All drift directions reverse when both BT and I_p are reversed. The flows Mach numbers that

include drift components have large values. However, when drift components are eliminated by taking averages of these measurements, the Mach numbers are typically within 0.2, which appears to be reasonable.

Results of filter bolometer camera during disruptions in Aditya tokamak :

The radiation power loss from Aditya Tokamak is routinely measured using AXUV bolometers. These bolometers are also used for radiation power loss measurement in fast disruptive events, during which there is a significant contribution from the photon energies below 22 eV. For these photon energies, the AXUV photodiode responsivity is much lower (~ 0.1 A/W) than its average responsivity (0.24 A/W). Hence, using the average responsivity value for the radiation power loss calculation can lead to significant errors. To prevent this it is essential to calculate an effective responsivity value by determining the contribution from photon energies below 22 eV. A filtered bolometer camera has been designed for the same. The camera houses three single channel AXUV bolometers out of which two view the plasma through filters and one has an unfiltered view. All the channels are located at the same poloidal location and view the whole poloidal cross-section of the plasma. Some initial results are shown in figure 2. Radiation power measured by filtered and unfiltered AXUV bolometers indicate that there is significant contribution from low energy (< 8 eV) photons in the radiation power during start-up and disruption phases of Aditya discharges.

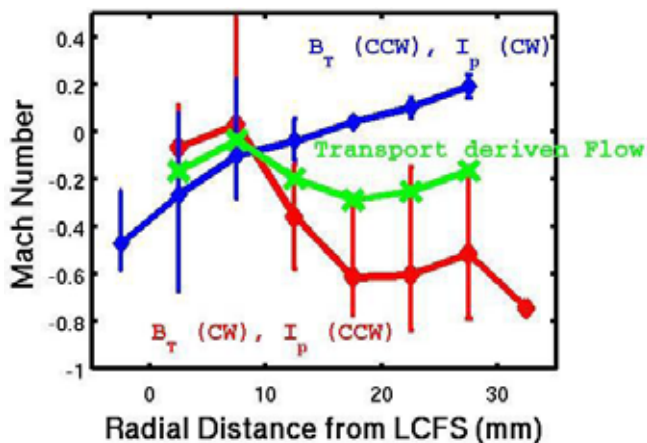

Figure A.1.1.4.1 The radial profiles of Mach numbers in two cases with BT and I_p in clockwise (CW) and counter clockwise (CCW) directions as seen from the top of the tokamak

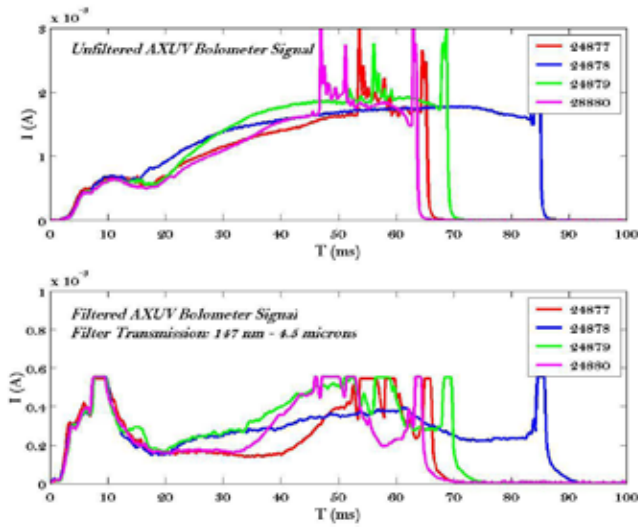

Figure A.1.1.4.2: Photo-currents from the filtered and unfiltered AXUV bolometer for different discharges. The data from filter bolometer show saturation indicating underestimates.

Measurement of diamagnetic energy in Aditya during ICRF pre-ionization experiment : We have measured diamagnetic energy, W_{dia} , in ohmically heated Aditya discharges, which were produced by using ion cyclotron resonance frequency (ICRF) pre-ionization. The measured W_{dia} , is compared with the estimated plasma thermal energy, W_H . The estimation of W_H uses measured values of central electron temperature of plasma T_{e0} , and chord-averaged plasma density, $\langle n_e \rangle$ and an assumption of $[1-(r^*/a)^2]^{1/2}$ dependences of both of them, where 'r' is the radial distance and 'a' is the minor radius of the plasma. Results presented in Fig. A.1.1.4.3(a) show W_{dia} as a function of input Ohmic power ($P_{in}=I_p V_L$, where I_p is the plasma current and V_L is the loop voltage). Results shows that the W_{dia} increases linearly the W_H [see Fig. A.1.1.4.3(b)]. The measured W_{dia} is in general higher than W_H , which indicates that energetic electrons may be present in ICRF pre-ionized Aditya discharges.

Runaway extraction by Local Pulsed Vertical magnetic field (LVF) : Non-thermal electrons in tokamak plasma are commonly observed in discharges with low densities and /or high level of impurities. Various methods have been used to control, suppress and extract the runaway electrons in tokamak. One of these methods is the application of local vertical magnetic field perturbation to extract the runaway electrons. A pair of new runaway extraction coil was designed, manufactured and installed on top and bottom TF coil I-Beam (near port no 2 & 3) of Aditya machine with ID 42.4 cm & OD: 51 cm. The distance from midplane (Plasma centre) to

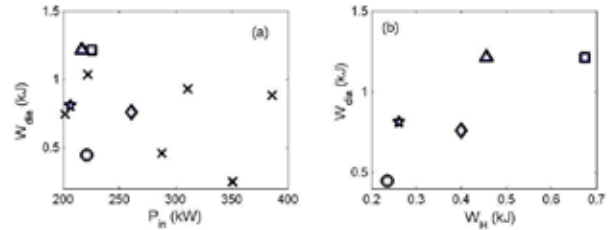

Figure A.1.1.4.3: (a) The diamagnetic energy as a function of input Ohmic power (b) The diamagnetic energy as a function of plasma thermal energy

coil centre was ~ 80 cm. The coils were powered by capacitor bank power supply and current was monitored with C.T (10 mV/1 amp). The coils produced local vertical field is in opposite direction to the actual equilibrium field. Maximum local vertical magnetic field of ~ 260 Gauss (measured using digital Gauss metre) at the plasma centre is produced by driving 4.2 kA of current through these coils. The experimental measured field values were in good agreement with simulated values of the magnetic fields at desired locations. Significant reduction of initial as well as current flat-top Hard X-rays has been observed by applying the local vertical field (LVF) produced by newly installed double coils. The local vertical magnetic field perturbation has been varied from 150 G to 260 G and its time of application was also varied from 0.5 ms to 4 ms with respect to the loop voltage starting time to remove the runaways generated during the breakdown and current ramp-up phase. Observations: (i) significant reduction in initial HXR (during first 15 ms) counts. (ii) LVF does not disrupt the plasma (iii) LVF was able to reduce HXR at any time during the discharge duration. The mechanism of runaway extraction is very simple. Due to the local vertical

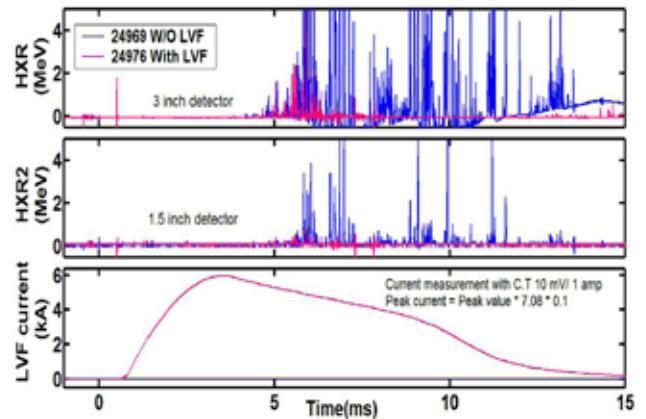

Figure A.1.1.4.4 Hard X-ray reduction shown with Local Pulsed Vertical Field..

field magnetic field perturbation, the particle moves in vertical direction in the region of perturbation field. This leads to a radial diffusion, which will be proportional to the particle velocity parallel to the total magnetic field. As the runaway electrons have higher parallel velocity, the runaway electron diffusion will be larger than the thermal particles. Thus magnetic extraction of the runaway population can occur without affecting the thermal component of the plasma. Radial movement of the plasma position towards the low-field (out-board) region as well as suppression of H-alpha and C-III, O-I impurity line radiation were also observed by applying the LVF current pulse at 20 ms into the discharge. The pulse length of LVF has been modified by adding more capacitor bank (10.5 mf/5 kV), which controls the plasma position more efficiently. LVF (Local Vertical field) effect on plasma parameters are summarized as follows : (a) Modified LVF moves the radial plasma position out-board and holds it steady for almost ~ 50 ms time from where the LVF pulse is applied (b) Observed significant reduction in Ha & O-I, C-III, Vis-cont impurity line radiation from where LVF pulse is applied. (c) Reduce runaway dominated plasma current and observed IP flattop in some discharges in presence of modified LVF current pulse. (d) 80% of discharges were repeatable with modified LVF current pulse. (e) Plasma electron temperature rises up to 425 eV to 475 eV measured with Soft X-rays diagnostic. In discharges with higher temperatures, Edge safety factor $q \sim 3$ and good control on MHD activities were observed.

Electrode Biasing Experiments: The underlying physics of low to high confinement (L–H) transition discovered in AS-DEX tokamak still remains an open question that engages the interest of fusion physicists all over the world. There is substantial evidence of radial electric fields at the plasma edge of tokamaks playing an important role in the L–H transition, and a simple method to create these fields in the tokamak edge is to use biased electrodes. However there are several experiments and theories have been put forward establishing the significant role of toroidal current density profile modification in the L–H transition. Some of the open issues still remained to be answered are: a) Charging of the flux surface, b) Current profile modification with biasing, c) Causality of different events, like setting up of electric field and commencement of plasma rotation. To answer some of the above we introduced a Molybdenum electrode of 0.5 cm diameter and 1 cm length inside the Last Closed Flux Surface (LCFS) of Aditya tokamak and biased it positively and negatively at different potentials. Preliminary results showed the previously observed modifications in other tokamaks like, H α reduction, plasma density and temperature rise are also observed in Aditya tokamak with the application of positive bias to the electrode. Detailed experiments are underway.

A.1.2 Superconducting Steady-state Tokamak (SST-1)

A.1.2.1 Status of the Device

SST-1 mission : The Team comprising of the SST-1 Cryogenics Division, SST-1 Magnets Division, SST-1 Assembly Division, SST-1 Vacuum Division, SST-1 Power Systems Division, SST-1 Data Acquisition Division, SST-1 Operations and Control Division & SST-1 Plasma Control Physics Division has been able to make some rapid and significant progresses on the SST-1 refurbishment aspects during 2011-12. Even though the testing of all SST-1 Toroidal Field (TF) magnets were completed in January 24, 2011; some repeat tests aimed at determining the thermal inertia in case of vacuum failures relevant to off normal operations in SST-1 were carried out till April 2011. The bridge joints concepts involving cable-in-conduit-conductors have also been tested successfully together with current leads validations up to 10000 A in helium flow during this period. Helium Refrigerator and Liquefier system had worked with > 99% reliability averaged over nearly thirty campaigns. In all the magnet tests, the feeding power supplies and magnet protections including quench detections have demonstrated the designed performances repeatedly. In parallel, all the SST-1 vessel modules and sectors had been refurbished and validated for their appropriateness towards usage in SST-1. All the sixteen sets of vacuum vessel 80 K thermal shields had been procured and validated through qualifying tests. Ground assemblies of the octant comprising of a pair of tested TF magnets, thermal shield assembled and tested vessel modules & necessary support structures had also been successfully done and the methodologies protocols had been established in these trials. Following these protocols, the machine shell had subsequently been assembled. The milestone of the SST-1 assembly was achieved with

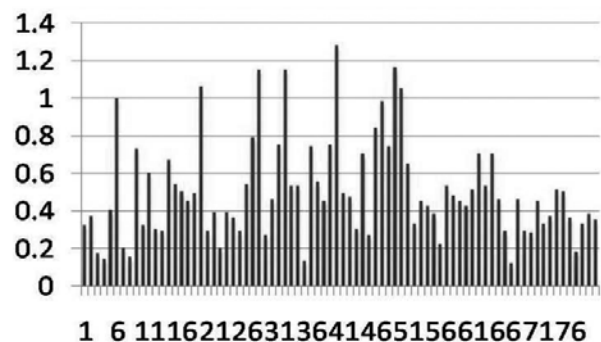

Figure A.1.2.1.1 The tested TF joints (Y-axis: resistance in nano Ohm, X-axis: Joints number)

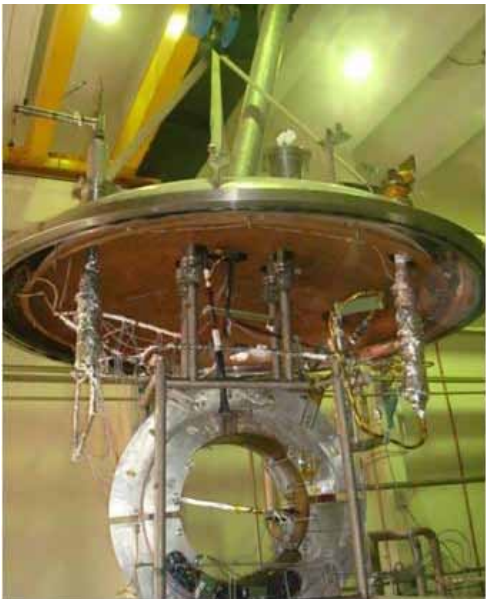

Figure A.1.2.1.2 Testing of refurbished PF-3 magnet of SST-1

the assembly of the bottom 80 K cryostat panels, TF bottom ring, helium headers and nitrogen headers and PF-3 bottom magnet on Feb 10, 2011. Subsequently, the longest and most challenging re-assembly of the machine shell comprising of eight octant and intervening eight vessel sectors began. The eight octant were fully assembled by Aug 10 and all the vessel sectors and outer-inter-coil-structures could be assembled by Oct 10, thereby completing the second milestone of SST-1 assembly. The focus of SST-1 refurbishment during 2011 was



Figure A.1.2.1.3 Successful refurbishment of PF-2 top coil

the reassembly of the SST-1 machine shell by Oct 2011 and initiation of the closer of the cryostat by March 2011, which is on schedule. During these activities, some significant activities related the refurbishment and testing of the damaged PF-3 (top) magnet in a modified cryostat, refurbishment of the resin blocked PF-2 (top) magnet, deformation correction of the vessel sector # 9 and full testing of the massive TR1 magnet has been carried out. The fabrication of the horizontal current lead assembly chamber, completion of ten pairs of

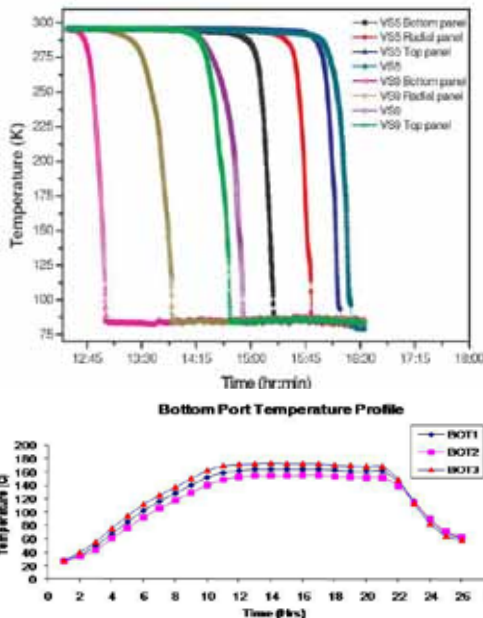

Left-top - Figure A.1.2.1.4 A typical assembled 80 K vessel module test
 Left-Bottom - Figure A.1.2.1.5 A typical SST-1 vacuum vessel baking result in a dedicated baking facility, Right - Figure A.1.2.1.6 Prototyping and application programming of proprietary Siemens 6RA70 controller for 12-pulse AC-DC converter power supplies

current leads, validations of the 80 K Boosting system capable of producing single phase nitrogen at 7 bar (a) as well as refurbishment of the hot nitrogen facility were some of the significant achievement of the Mission team. Dedicated large data storage facility establishment; e-logging facility meant for SST-1 experiments, GPS based synchronization of the heterogeneous platforms; establishment of joint and integrated protocols between front end signal conditioning, DAQ and central controls; integrated testing (phase-II) of the first plasma diagnostics through DAQ are some of the major activities successfully carried out outside the SST-1 machine shell during 2011. Towards the end of 2011, a 'technical review' on the subsystems of SST-1 as well as its assembly progress was also carried out with domain knowledge experts. Preliminary measurements on the quality of the TF fields from the assembled TF were also reviewed and found to be acceptable. SST-1 Power Supply Division has successfully carried out 'Prototyping and application programming of proprietary Siemens 6RA70 controller for 12-pulse AC-DC converter power supplies'.

Beginning 2012, SST-1 Mission has focused on the remaining tasks of SST-1 reassembly namely the activities leading to the closure of the cryostat. A detailed 'engineering validation' of the assembled SST-1 machine shell will be undertaken in the early second quarter of 2012 where the 'field errors' and the engineering testing of the magnet system, cryogenic system, vacuum system, power supplies and the control systems will be carried out establishing the SST-1 machine both as an adequately assembled 'mechanical device' as well as a quantified 'magnetic device'. In parallel to these activities, the out-side cryostat assembly are being carried out. Following the successful 'engineering validation activities', the attempts towards the 'first plasma' are foreseen with both with and without pre-ionization means aiming to establish SST-1 as a creditable 'plasma device' capable of steady state plasma experiments.

A.1.2.2 Diagnostics Developments

A fast scanning Langmuir probe drive for SST-1 tokamak :
 A fast scanning Langmuir probe drive is designed for studying radial profiles of various plasma quantities in SST-1 with high spatial resolution (figure A.1.2.2.1). The drive will make the Langmuir probes scan of 200 mm length in 200 ms in the scrape-off layer. The motion occurs in two steps viz. slow and fast, actuated by two pneumatic cylinders. The slow acting pneumatic cylinder fixes the system at a reference level from where it can be launched many times during the 1000 sec-

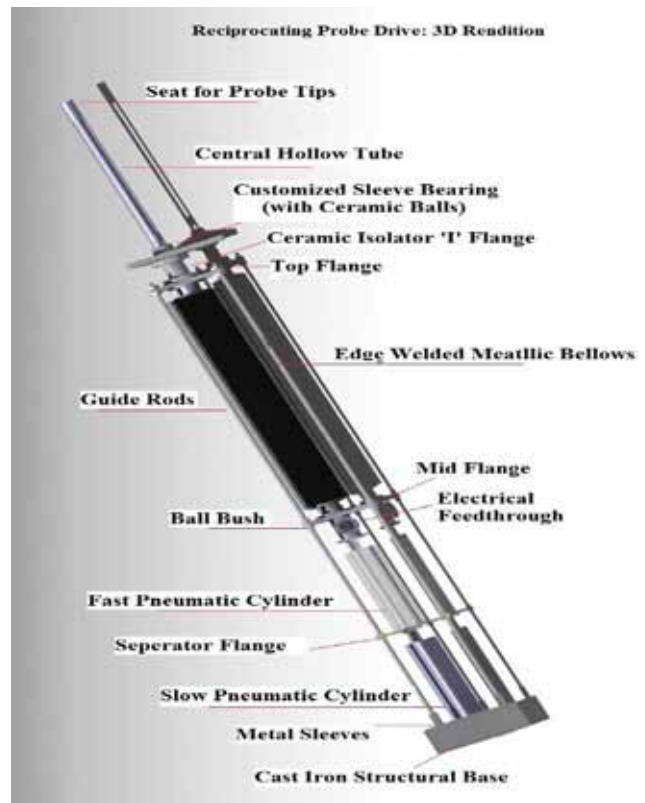

Figure A.1.2.2.1: Schematic design of fast scanning Langmuir probe drive for SST-1 tokamak

ond SST-1 plasma cycle. The system incorporates provision to vary the final vertical reach of the probes. A single bellows design leads to a substantial reduction in cost and weight adding reliability at the same time. The movement of the probe drive is controlled remotely by means of a programmable logic control system with a resolution of better than 1 mm.

Far Infrared Interferometer for SST-1 : The plasma density measurement in SST-1 will be done by multiview, multichannel 118.8 micro-m far infrared (FIR) laser interferometer. Due to strong absorption of 118.8 micro-m radiation by atmospheric water vapour, the beams are transported from FIR lab to SST-1 hall through dielectric waveguides in dry atmosphere. The vacuum enclosure to enclose optics for coupling FIR beams from laser output coupler to the waveguides inside lab have been fabricated and the coupling optics was mounted and aligned inside these vacuum enclosures. The waveguided transport ends near the tokamak and the beams are transported in free space. The optical components for free space propagation are to be supported by a support structures. The support structure assembly is ~7.25 m high and consists

of (i) a rigid frame with stainless steel pipe columns anchored to the basement floor slab; (ii) seven vibration isolators supported on these pipe columns and (iii) a modular support structure consisting of 13 individual modules and their inter-links. The fabrication of the support structure assembly was completed during the year and final testing of the same was carried at vendor's site. The base frame of the assembly was erected inside the SST-1 tokamak hall. The radiation source for lateral viewing option is being developed. The discharge tube of radiation source was mounted on its support structure and tested for the vacuum. The bench test experiments to study the changes in polarization states of laser beams by various reflectors along the beam path were carried out during the year. The final polarization states were estimated both by classical method technique and by using rotating quarter wave plate method and estimating Fourier coefficients.

Study and Development of Image-Fusion Techniques : Image Fusion is the process of combining images from different sources to obtain a single composite image with extended and enhanced image content, superior to the base images. It has revolutionized astronomy, material testing, medicine etc. since its birth. Fusion may be for extension in time, space or spectral region. Nowadays, many imaging plasma diagnostics are emerging, established and widely operated on plasma devices. The image fusion technique can be utilized for these diagnostics in different ways, to fuse data from different diagnostics or fusing images obtained from the particular diagnostic. The resultant fused image provides more information and improves understanding. The captured image of a scene may be in the X-Ray, UV, Visible and Infrared or in Microwave region of the spectrum depending upon the imaging source & detector type. Or the individual image may be with different depth of focus, from different viewing angle or at different time. The Image fusing techniques aim at fusing such images to improve the perceptibility or information content of a scene. Image fusion can occur at the pixel level

or transformed image level or highest decision level. Image fusion using pyramid decomposition technique and the algorithm for its implementation is developed. It is tested with simulated images. These images are then enhanced and fused using the algorithm developed and the quality is assessed. Figure A.1.2.2 shows an example of images having different depth of focus and after application of image fusion technique the resultant image shows uniform depth of focus.

A.1.2.3 Heating and Current Drive Systems

Lower Hybrid Current Drive (LHCD) System

A 70kV solid state crowbar system is installed, tested, commissioned and integrated with the 70kV, 22A high voltage power supply (HVPS) for protection system of klystron. The high voltage power supply is installed far away from klystron site and is connected to klystron through approximately 100 meter long cable. This accounts for large stored energy in the cable which needs to be dissipated through crowbar system in an event of klystron arc. To ensure protection of the klystron it is mandatory to demonstrate that dissipated energy during crowbar should not exceed 10J. As a baseline activity, the old ballast resistor values for 200kw operation of klystrons with rail gap crowbar (30 Ohms in RC panel and 155 Ohms in SST Hall) are taken for the commissioning and 10J wire survival test of the crowbar system as mentioned in figure a.1.2.3.1. Here klystron old configuration is retained with 30 Ohms in RC panel and 155 Ohms in SST hall. Channel-1, 2, 3 and 4, represents total current (10mV/A), voltage on crowbar (channel inverted, 1V/-15kV), crowbar current (10mV/Amp) and current through wire (10mV/Amp) respectively. The 10J wire survival test was successfully done with old resistor values. However, a large spike in voltage is observed immediately after the initiation of the crowbar system. Careful analysis revealed that it is due to chattering of the



Figure A.1.1.2.1 Figure A.1.2.2.2 Fusion of visible images out of focus. (a) Visible image with focus on back object. (b) Visible image with focus on front object. (c) Fused image with uniform focus.

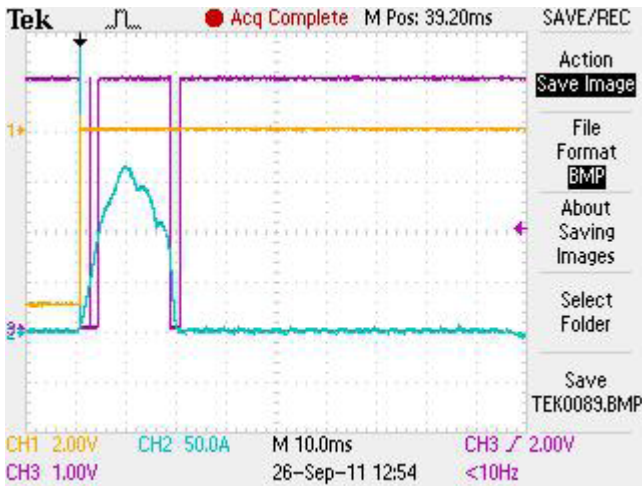

Figure A.1.2.3.1 Typical waveform of current and voltage obtained during successful 10J wire burn test of high voltage power supply with solid state crowbar system.

mechanical switch. Finally, the solid state crow bar system is directly connected to the high voltage DC power supply and the power supply is short circuited through the solid state crow bar switch. The initial large spike (which was observed with 10J wire-burn test) is not observed in this case which qualifies it for its application for conducting site acceptance test of the klystrons at rated power, as well as for regular klystron operation. For 500kW CW operation, there were issues like large number of resistors, space constraints, huge power dissipation (~75kW) and overall efficiency of the sys-

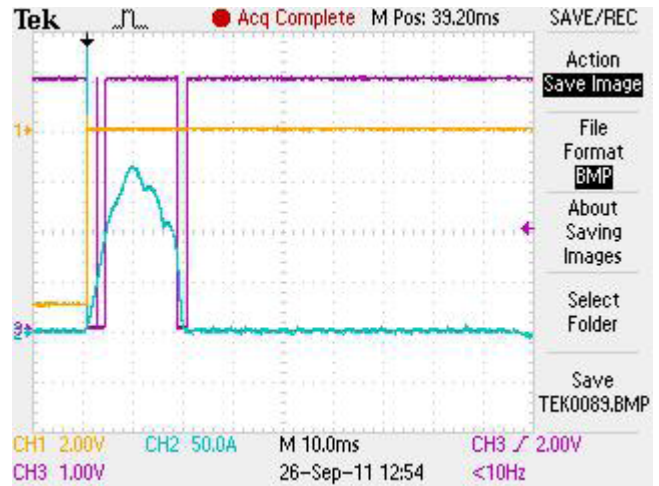

Figure A.1.2.3.2 Typical waveform of current and voltage obtained during successful 10J wire burn test of high voltage power supply with solid state crowbar system is shown with optimised ballast resistor.

tem. Through rigorous exercise, the ballast resistor value was optimised. As wire burn survival test is mandatory for every change in the passive circuit components, repeated wire tests were conducted and the resistors are successfully brought down to a level of 10-40 Ohms (see figure A.1.2.3.2, Here klystron configuration is changed with 10 Ohms in RC panel and 40 Ohms in SST hall.).

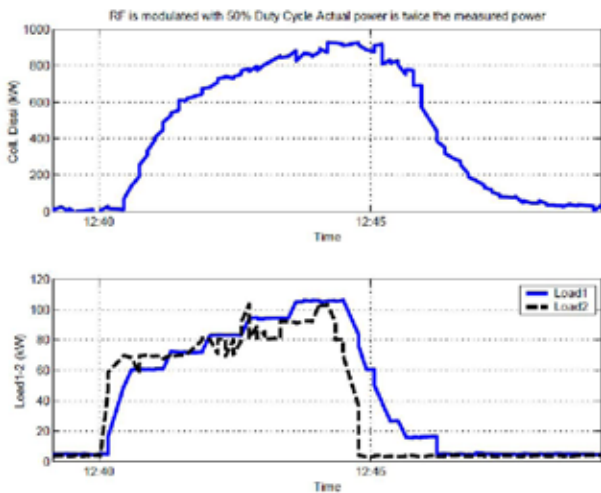

Figure A.1.2.3.3 Temporal evolution of heat load dissipated in klystron collector (top figure) and in high power rf dummy load (bottom figure) connected to first (load1) and second (load2) output arm of the klystron.

In parallel, the Regulated High Voltage Power Supply (RHVPS) has been tested for full voltage with recent testing demonstrating operation of it at 80kV/24A for 1 second. The 10J wire-burn testing has been successfully conducted at 80kV which qualifies the RHVPS for integration with LHCD klystrons source. This activity is done in co-operation with RHVPS Development Team (NBI Group). The preparation work for integrating RHVPS with klystrons system is underway. Subsequently, preparation of test bed for installation and commissioning of newly procured klystrons at site is prepared. The auxiliary systems are integrated with the main high power CW test bed. With new DC power supply and solid state crowbar unit, the klystron, procured earlier, has been placed in the prepared high power test bed and for the first time the klystron along with its sub-system is operated at rated electrical power (64kV/18A) in diode mode for about five minutes. High power rf output in excess of 400kW (greater than 200 kW in each arm) with 50% duty cycle (50mS on time and 50mS off time accounting for average dissipated power in excess of 100kW in each arm) is

dumped on high power CW water dummy loads. The above measurements were confirmed by calorimetric measurements and a typical temporal evolution of power in the collector and dummy load is shown in the figure A.1.2.3.3. The klystron was operated with electrical parameter at $\sim 64\text{kV}/\sim 18\text{A}$ ($\sim 1.15\text{MW}$). About 925kW was dissipated in collector (top figure). A train of rf pulses with 50% duty cycle (50ms ON, 50ms OFF) is obtained and dissipated in dummy load. The graph shows maximum dissipated rf power in water loads to be in excess of 400kW (average power in excess of 100kW in each arm). The factory acceptance tests of the new klystrons and its sub-system is successfully carried out at rated power (500kW , 1000seconds) by operating the tubes at full DC parameter ($\sim 65\text{kV}$ and $\sim 20\text{A}$ beam current). The same has been received at IPR and preparation is being made for testing it at site. The tank preparation for the klystrons is under progress. The rf window which was sent to PPPL for repair of coolant line has been received at IPR, after being repaired by PPPL. The repaired coolant line has been successfully tested. After obtaining CDC clearance and completing the tendering procedures for the proposed LH lab, the construction work of the lab has been started. The preparation activities for putting the support structure for LHCD in-vessel components in the radial port of SST1 machine are underway. The support structure would be welded in the radial port and isolated from the machine ground by using ceramic bushes, sleeves, plates, etc.

Electron Cyclotron Resonance Heating (ECRH) System

82.6GHz/0.2MW ECRH system for SST-1: The 82.6GHz ECRH system would be used in SST-1 for breakdown and start-up experiment at fundamental harmonic at 3.0T operation and second harmonic at 1.5T operation. The 82.6GHz Gyrotron has been already tested for high power $\sim 170\text{kW}$ CW (1000s duration). In order to operate the Gyrotron in pulsed condition and to monitor the power accurately, a pulsed dummy load has been procured and received at IPR. The testing of Gyrotron in pulsed condition is planned in first half of 2012. The new stable filament power supply (FPS) for 82.6GHz Gyrotron has been procured at IPR and is under commissioning stage. In order to upgrade the system for reliability, anode modulator power supply is also under procurement

RHVPS for Gyrotron testing in pulsed condition : The RHVPS (Regulated High Voltage Power Supply) is required to

test the Gyrotron in pulsed condition. The RHVPS is in advance stage of commissioning. The communication between RHVPS (regulated high voltage power supply) and ECRH lab has been established and under routine check. The electronic cards to set-up communication between RHVPS and ECRH have been tested and installed at ECRH DAC Side. The ECRH DAC software is also modified to operate the Gyrotron with RHVPS. The communication has been tested successfully between ECRH DAC and RHVPS control.

70kV Ignitron crowbar system : During the high voltage operation of Gyrotron, a crowbar system is used for the protection of tube against any fault like arc, beam over current and high dI/dt etc.. A two series ignitron crowbar system suitable to operate up to 70kV is in advance stage of design. The 50kV ignitrons have been procured and trigger modules are under procurement. The other accessories like resistor, capacitor and isolation transformer etc. are also in advance stage of procurement.

Neutral Beam Injection (NBI) Heating System

NBI Power Supply and Data Acquisition & Control : Operation and maintenance of the power supply system and control and data acquisition system were carried out as routine. To improve the reliability of the Neutral Beam System (NBI), actions were initiated to upgrade the AC-AC converters of the Ions Source Power Supply System. One sample has been rigorously tested for harsh environment operation; the full system is planned for installation in few months' time. Upgrade of the data servers for the NBI system was also completed with integration of new hardware. Software development is in progress for the new integrated data acquisition system.

--!!!--

A.2. Fusion Technologies Development under XIth Five Year Plan

A.2.1. Fusion Relevant Prototype Magnet Development

This programme had rapid progress during 2011-12 which was the last year of the five years earmarked for this program under XII plan initiative.

NbTi & Nb₃Sn superconductor Development : NbTi and Nb₃Sn are the basic technical superconductors for fusion relevant magnet winding packs. Institute for Plasma Research (IPR) and Atomic Fuels Division (AFD) at Bhabha Atomic Research Center (BARC) have successfully collaborated developing processes and technologies related to NbTi and Nb₃Sn based high current carrying superconductors. Multifilamentary multiply stabilized sub-millimeter diameter superconducting strands in single lengths of kilometers contains several hundreds of micron size twisted filaments for both NbTi and Nb₃Sn strands in specific superconductor to non-superconductor ratio. The NbTi superconducting strands are manufactured by extrusion and cold working whereas Nb₃Sn multifilamentary strands are manufactured through the 'internal tin' routes. After manufacturing long length strands, the strands are twisted in specific configurations in multiple stages in accordance with the cryogenic stability, dynamic stability and thermal stability of the cable designed. The designed cable is actually a twisted cable of superconductors in multiple stages jacketed inside a leak tight conduit. This configuration is popularly referred as cable-in-conduit-conductor (CICC) configurations. Long lengths of CICC were manufactured and were successfully tested. The Nb₃Sn strands are fabricated through 'internal tin' route and employees high homogenous superconductor grade Niobium (Hi Ho Nb) having residual resistivity ratio RRR (ratio of Nb at 300 K

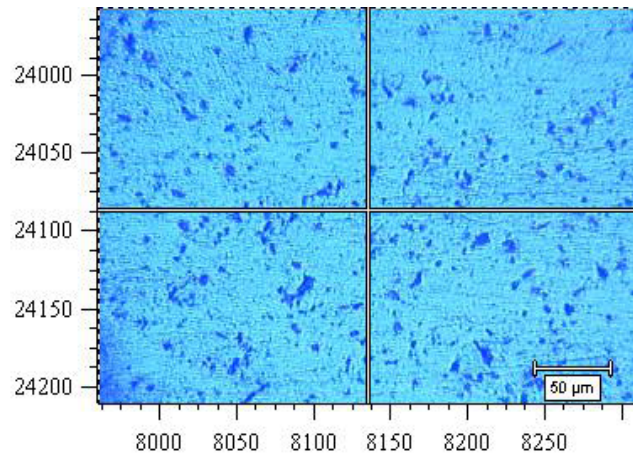

Figure A.2.1.1 SCM of Hi Ho Nb developed

to that at 10 K) in excess of 300. On laboratory scale, superconductor grade Nb have been produced aided with 'Solvent Extraction' of Nb₂O₅ (Niobium Pentoxide) followed by carbo-thermic reductions as a collaborative initiative between Institute for Plasma Research and Institute for Minerals and Materials Technology (IMMT). Figure A.2.1.1 shows the Hi Ho Nb developed.

Insulation Impregnation systems for Fusion Grade Magnets : Insulation constitutes an important aspects of fusion relevant magnet winding pack since insulations not only provides the electrical isolations against break-down but also is required to be compatible to helium environment (5 K) as well as must be mechanical strong against thermal and operating electromagnetic stresses. Cyanate Ester, Bisphenol and FRP (Fibre Reinforced Polymer) based insulation systems have been envisaged for fusion grade prototype magnets winding packs These insulation systems are expected to be resistant to moderate doses of neutron fluence as far as their thermo-mechanical characteristics and breakdown strength are concerned. Such an insulation impregnation system has

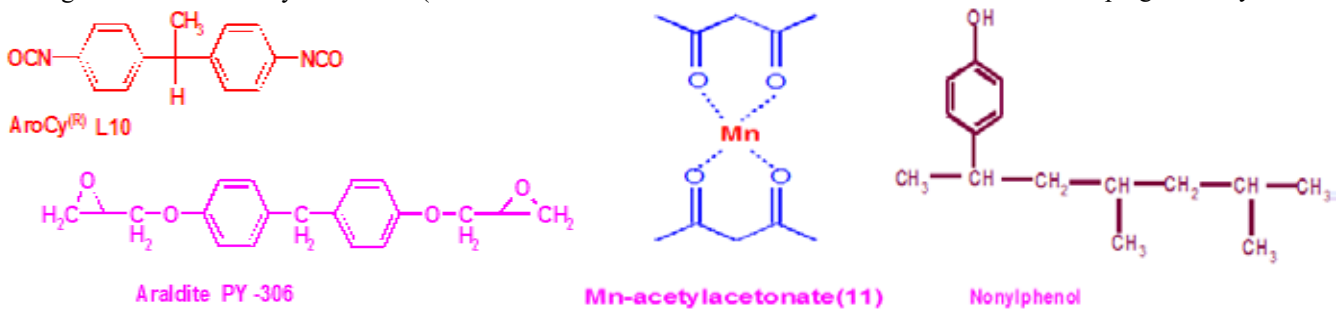

Figure A.2.1.2 Basic constituents of a radiation resistant insulation system developed (a) AroCyL10, Araldite PY-306, (b) Mn-acetylacetonate(11) and (c) Nonylphenol

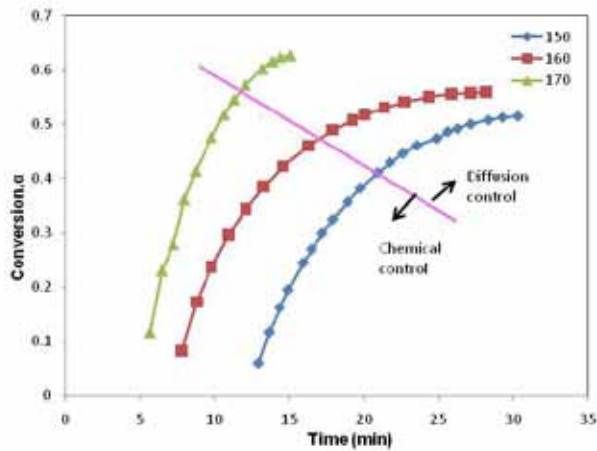

Figure A.2.1.3 The chemical kinetics of the insulation system developed

been developed with the chemical kinetics, order of reactions, pot life, loss tangent, break-down strength, ultimate tensile strength and inter-laminar shear strength characterizations being completed. The basic constituents of the insulation system are shown in figure A.2.1.2 whereas a typical chemical kinetics is shown in figure A.2.1.3.

A.2.2. Prototype Divertor Cassette Development for Fusion Grade Tokamaks

Prototype Divertors Division (PDD) of IPR deals with design and development of divertors for fusion grade tokamaks. During year 2011-12, the division continued its efforts in developing new technologies and establishing new test facilities relevant to materials & components of tokamak diver-



Figure A.2.2.1 Experimental set-up for High Heat Flux testing using Plasma Torch at NFTDC

tors. Major activities of the division includes procurement of various subsystems for new high heat flux test facility using electron beam as heat source, design of high pressure high temperature water & helium coolant loops, procurement of ultrasonic-flaw detection system, fabrication of ITER-like divertor cassette body and support structures for vertical targets and dome, developing fabrication technologies for divertor targets & dome targets, development of new tungsten based materials and their characterization, high heat flux testing of test mock-ups, procurement of precision material cutting machine, procurement of facilities for materials studies.

Divertor Cassette Body Development : Fabrication of Divertor Cassette Body and support structures for vertical targets and dome is a major activity of the division. Purchase process during previous attempt was stopped due to insufficient response from the Indian vendors. Tender document is re-written and second attempt is being made to get the fabrication done by Indian fabricators

Divertor target development : Tungsten mono-block test mock-ups developed by NFTDC are checked for their thermal performance under incident heat flux using plasma torch facility at NFTDC, Hyderabad. The plasma gun is mounted on a robotic arm programmed for fast rastering to generate uniform heat flux over entire top surface of the test mock-up. A portable high pressure high temperature water circulation system HPHT-WCS (provided by PDD of IPR) is used for active cooling of the test mock-up. The HPHT-WCS is operated in pressure range 5 – 18 bar and temperature range 30°C – 90°C with a maximum flow rate of 185 LPM. Maximum incident heat flux of 3.8MW/m² is obtained by operating the plasma torch at 20 KW (considering 30% power conversion efficiency). Corresponding extracted heat-flux is 3MW/m² using calorimetric data for inlet water at pressure 15 bar, temperature 80°C and flow-rate 125 LPM. The maximum temperatures observed using pyrometer on tungsten surface is 575°C and that at copper tube surface temperature measured by K-type thermocouples is 255°C. These results are validated and compared with the finite element analysis carried out using ANSYS.

Copper deposition on CFC material : Development of technique to deposit copper on CFC material for attachment with copper alloy heat-sink is in progress at Magod Laser (Bangalore) using Laser-Cladding technique. The surface texturing of CFC to increase surface area of the contact will also be done using laser texturing process.

Tungsten Material Development: Alloying of tungsten with transition elements (Ni, Fe etc.) and rare earth oxides (La_2O_3 , Y_2O_3) results in better thermo-mechanical properties as compared to that of pure tungsten. Synthesis of tungsten alloys is, therefore, carried out in dynamic hydrogen atmosphere in conventional tubular furnace. Various materials synthesized includes : Pure W, W + 1% La_2O_3 , W + 1% La_2O_3 + 1%Ni, W + 1% La_2O_3 + 0.5%Ni + 0.5%Fe. Efforts are being made to optimize synthesis conditions so that stringent qualification criteria of fusion materials can be achieved. Various synthesis methods have been approached to synthesize W-Cu based Functionally Graded Materials (FGM). These methods include conventional furnace sintering and microwave sintering technique. The synthesized specimens have been characterized for their physical properties. Optimization of material processing parameters is in progress.

Materials Studies Using Miniature Specimen Techniques :

The miniature specimen technique, a non-destructive method for the evaluation of mechanical properties of materials, is employed for the mechanical characterization of tungsten specimen using Ball Indentation set-up at IGCAR. The disc shaped specimen of diameter 8 mm and thickness 0.5 mm is indented with ball of Tungsten Carbide of diameter 1mm. The true stress versus true plastic strain curve, for the determination of mechanical properties of tungsten specimen, is derived from the indentation depth and diameter by employing Haggag model. Apart from the room temperature analysis, mechanical characterization of tungsten at high temperatures, using small punch test technique is in progress.

High Heat Flux Testing of brazed macro-brush test mock-ups: Brazed macro-brush test mock-ups developed by NAL (Bangalore) with Graphite and Tungsten tiles thermally attached to surface of a copper-alloy block are tested for their thermal performance under high heat flux conditions. The experiments were performed at Plasma Materials Test Facility of Sandia National Laboratories (Albuquerque, USA) using EB-60 electron beam. Tungsten macro-brush brazed test mock-ups could withstand several thermal cycles of incident & extracted heat-flux of 19 & 9 MW/m² respectively

Computational Analysis of HHF Test results: Experimental data obtained during high heat flux test (HHF) is compared with thermal hydraulic computer simulations using COMSOL v4.1 and ANSYS v12 software. Computation of temperatures at surface of the test mock-ups as well as at interface joint near copper alloy heat-sink shows good comparison with the experimental observations.

Development of high heat flux test facility using electron beam

(a) High Power Electron Beam System : Purchase order placed with international supplier for procurement of a high power electron beam source capable of producing 200kW/45kV beam power for high heat flux testing. The beam will be integrated with the vacuum chamber & target handling facility for testing of materials and components.

(b) Data Acquisition & Control System : Conceptual design of data acquisition and control system for the high heat flux test facility has been prepared and budgetary quotations received for supply of the system.

(c) Diagnostic & Calibration System : Most of the diagnostic instrument like IR pyrometers, IR Camera has been delivered and tested for its performance. Calibration facilities for such instruments are being set-up at IPR. Calibration facility for thermocouples is ready for the usages and calibration source for IR Pyrometer and IR Camera is in the process of procurement.

(d) High Pressure Water Supply System: The high pressure high temperature water circulation system has been designed to provide coolant water during HHF testing of test mock-up or components. It has been designed for maximum heat removal capacity of 210 kW. In this test loop, de-mineralized water (D.M water) is used as a working medium and system can operate in the pressure range of 5 bar to 60 bar and the temperature range of 25°C to 160°C with a maximum flow rate of 300 LPM. Inert gas pressurization method is used to pressurize the DM water in the pressure vessel using nitrogen. Calorimetric data acquisition system (DAS) will be installed to record and control various test parameters viz. pressure, temperature and flow rate.

(e) High Pressure Helium Cooling System: Future Divertor concepts for power plants envisage the use of Gas coolants, primarily Helium gas, due to its inertness to make use of the power entering the divertor into a power conversion cycle. However Helium has a very low thermal conductivity and special techniques have to be applied to achieve a good heat transfer coefficient. The helium cooling system that is being developed is mainly to perform thermal hydraulic investigations for testing and optimization of such concepts, thermocyclic tests for testing brazing joints and mechanical integrity of components at high heat fluxes. Tender for design and

manufacturing of the system has been released and technical evaluation of the bid is going on. Challenging areas in the system includes design on the He – circulator, recuperator, design of high temperature valves and integration of the test section to the loop. Indigenous development of some components may have to be done if they are not readily available in the market.

(f) Vacuum Chamber & Target Handling Facility : Purchase order released for design and manufacturing of a D-shaped vacuum chamber with double walled cooling along with target/component handling facility. The electron gun will be mounted on a horizontal port of the vacuum chamber so as to produce a horizontal beam that can be rastered on the target/component being tested. The dimensions of the chamber are assumed to be of diameter 2.4 m, height 1.5 m with double wall cooling system to accommodate full-scale mock-up for testing. The target handling facility for mounting mock – up using cantilever supports is designed in such away that it is supported from outside with a separate trolley arrangement moving on a railing system. The supporting structure for the chamber is designed to be a flat surface with leg type support. Design and structural analysis of D-shaped double walled vacuum vessel has been carried out. Thermo hydraulic analysis of double wall cooling has been carried out. Detailed engineering design of vacuum chamber as per ASME section VIII Div 1 is in progress.

Brazing Studies and Brazing Experiments : Attachment of tungsten materials with copper-alloy heat sink material is being developed under vacuum and inert gas atmosphere. Copper casting has been done in an inert gas (Ar + 4% H_2) atmosphere to attach copper with tungsten materials. The copper coated tungsten material will be brazed with copper alloy heat-sink in vacuum condition using suitable low temperature brazing filler alloys.

Divertor Remote Handling studies : Divertor assembly using remote handling mechanisms requires complex mechanical assembly-level designs integrated with control system modelling. This in turn requires evaluation & management of complex interactions between disciplines including motion, structures, actuation & controls. Development of Remote handling tools like Cassette Multifunctional Mover (CMM), Cassette Toroidal mover (CTM), Water Hydraulic Manipulator (WHMAN) etc requires a strong Virtual Prototyping software which can integrate mechanical components, pneumatics, hydraulics & control system technologies to en-

able engineers to build and test virtual prototypes that accurately account for the interactions between these subsystems. Mechanism & motion studies are critical in the design of such systems. After extensive evaluations and series of discussions with experts with other organizations in India, it is observed that ABAQUS & CATIA SYSTEMS software from DASSAULT SYSTEMS are capable of delivering accurate flexible multi body dynamic simulation solutions integrated with corresponding control system designs so that virtual prototypes of remote handling tools can be developed. Efforts are in progress to procure both these software.

Material Test Facilities : Purchase order placed with Dynamic Systems Inc. USA for procurement of Gleeble-3800 thermo-mechanical simulator system for material testing under tensile/compressive loads at elevated temperatures up to 220°C. System has been delivered at IPR and it is expected to be installed by July-2012. Gleeble 3800 System will be used for different process simulations like Hot rolling, Forging, Continuous Casting, Weld HAZ cycles, Heat Treatment, Diffusion bonding, Powder Metallurgy/Sintering etc. Gleeble 3800 System will be also used for different material testing applications like Hot Tensile Testing, Hot Compression Testing, Fatigue Testing (Thermal & Thermal-Mechanical), Creep Testing, Dilatometry/ phase Transformation studies, Stress Relaxation studies, etc. Purchase order has been placed for Laser Flash Equipment capable of measuring thermal diffusivity from room temperature up to 210°C.

Precision Material Cutting : Prototype Divertors division is in the process of procurement of Abrasive Water-Jet cutting machine that can be used for precision cutting of various materials including Tungsten, CFC (Carbon Fibre Composite), Stainless Steels, etc. This machine allows precision cutting at room temperature with minimum wastage and near-net finish.

Electromagnetic Analysis of Divertor: Efforts are being made to carry out electromagnetic analysis of the ITER-like divertor using suitable codes for electromagnetic analysis. Computational codes such as JMAG, Maxwell, Ansys EMAG Multiphysics, Typhoon, Tornado are being studied for suitability to conduct electromagnetic analysis of Divertors by comparing various features and qualities.

Thermal Hydraulic simulations on Helium gas cooled heat-exchangers : Helium due to its poor thermal conductivity poses a serious problem in effectively extracting high heat

fluxes. Yet, it is the best coolant for reactor environment due to its chemical and neutronic inertness. Various configurations are being investigated to enhance the heat transfer coefficient. Initial studies involve using Computational Fluid Dynamics (CFD) for studying various methods and optimization, and later experimentally verify the optimized results to establish the technology. A promising concept that will be studied is the Jet Impingement technique which will be a starting point of the investigations being carried out. Collaborative work with BARC has been initiated for thermal-hydraulic simulations, fabrication and testing of a scaled down mock up. Purchase order has been placed for procurement of the Star CCM+ software.

Non-Destructive Testing & Simulation Studies :

(a) **Ultrasonic Testing Simulation Software:** CIVA 10 software is procured for simulation of ultrasonic wave propagation through materials for non-destructive testing purpose. Propagation of ultrasonic waves in tungsten mono-block and its interaction with known defects was simulated using CIVA 10. With CIVA 10.1 following simulation has been carried out: Probe Beam Simulation, Copper Tube inspection with IRIS (Internal Rotary Inspection System) Probe, Copper Tube Inspection with Circular Phased Array Probe, Multilayer Defect Problem. Customised circular phased array probe suitable for inspection of joint between Mono-block and copper-alloy tube is being simulated.

(b) **IR-Thermography Defect Size Quantization:** Infrared thermography of copper monoblock with known defects was carried out and experimental results were validated using simulated results.

(c) **Thermal Diffusivity Measurements:** Thermal diffusivity and thermal conductivity measurements of tungsten materials (procured from international manufacturers as well as the materials under development) have been carried out at elevated temperatures up to 1000C using Laser flash thermal diffusivity measurement system.

(d) **IR-Thermography Set-up:** Infrared thermography of a graphite and tungsten macro-brush type mock-ups before and after HHF test was carried out using in-house Infrared thermography set-up at IPR. Mathematical simulation has been carried out to calibrate defect size with surface temperature using Comsol v4.1.

A.2.3. Test Blanket Module (TBM)

The Indian Test Blanket Module (TBM) Lead-Lithium cooled Ceramic Breeder (LLCB) development is under progress at Institute for Plasma Research (IPR), Gandhinagr, Gujarat. The TBM will be assembled in one of the radial port of ITER machine for testing. The Research and development oriented towards this TBM covers major technologies development required for the future DEMO blanket. The scientists and engineers from IPR, Gandhinagar, BARC, Mumbai and IGCAR Kalpakkam are involved in the R&D of TBM related technologies, such as, Fusion Neutronics, Engineering Design, Safety, Liquid metal technologies, Thermo-fluid MHD, Lithium Ceramics, Beryllium pebbles, Structural Materials, Fabrication Technologies for the TBM programme. As per the Memorandum of Understanding between IPR-BARC and IPR-IGCAR the development tasks and related R&D are in progress. IPR scientists and engineers jointly work with the experts for the technologies development.

The LLCB TBM design activity is focused on the optimization of TBM design with respect to neutronic performance and high-grade heat extraction by keeping the temperature within allowable limits. In this process, various internal configurations has been studied in details such as series flow and parallel flow conditions. It is observed that the parallel flow configuration provides more advantages from MHD pressure drop limits and the corrosion levels with respect to the required flow velocities in Lead-Lithium flow in channels. The present design is focused on parallel flow configuration of liquid metal inside the TBM.

TBM related R&D activities are in progress to address the critical issues in blanket systems. A bouncy driven loop was designed, fabricated and commissioned in IPR. This loop is used for corrosion experiments with Reduced Activation Ferritic Martensitic Steel (RAFMS) samples. The loop has completed ~3000 hours operation. A Pump driven Lead-Lithium loop with indigenously developed components (Electromagnetic pump (EM), Heat exchanger, Valves, Test section etc..) for corrosion experiment is successfully commissioned and set for operation in IPR. EM pump for MHD loop has been delivered to IPR and the testing of the pump is under progress in TBM lab at IPR. MHD code development for Thermo-fluid MHD studies in single LLCB channel has been completed

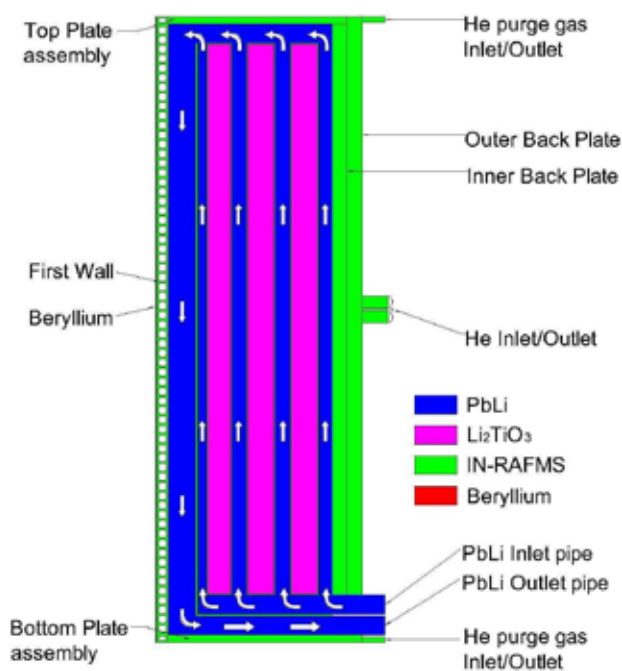

Figure A.2.3.1 Schematic view of Indian LLCB TBM

successfully. Presently 3D analysis is under progress. The schematic view of the LLCB TBM is shown in figure.A.2.3.1. The commercial melts of RAFMS has been delivered to IPR in the form of plates (6, 8, 12, 18, and 24 mm). These plates will be used for the R&D activities. The fabricability of the material and characterization of Indian RAFM steels for ITER-TBM program is under progress. Creep machines for has been delivered to IPR and RAFMS samples testing are under progress. Lithium titanate pellets has been produced at IPR (Lab scale) by solid-state reaction and Solution combustion process. Pebbles production by extrusion and spheroidization is under progress. The process team under an MOU with IIT-Gandhinagar has prepared preliminary design of helium compressor for 0.2 kg/sec and 1kg/sec. Vendor interaction for fabricating the impeller is under progress. With reference to the interface between the Indian LLCB TBM system and ITER Central Interlock System (CIS) and Central Safety System (CSS), ITER had asked Indian TBM team to prepare the interface requirements and in this regard, TBM team worked out the CIS and CSS based on the identified accident events in ITER and submitted a report to ITER. The design of hydrogen isotope permeation experimental set-up is completed and the tender has been raised for its fabrication. Under the INDO-Russian Scientific and Technical cooperation, 2nd



Figure 2.3.2 Pump driven Lead-Lithium loop at IPR

IN-RF workshop was organized in IPR to review the TBM engineering design and initiate R&D collaboration in critical areas. The workshop was successful, IN and RF team analysis was verified and crosschecked. Further action plan was prepared.

A.2.4 Negative ion Beam Source

Neutral Beam Injector system having energy $> 100\text{keV}$ for fusion purpose need negative hydrogen based ion source. To avoid frequent maintenance inductively coupled RF ion source is desirable. Under XIth plan, IPR has started its own program on negative ion beams by setting up an inductively coupled negative ion source (1MHz, 100kW). The source ROBIN is capable to produce plasma of density $10^{12} - 10^{13}\text{ cm}^{-3}$ and deliver $\sim 10\text{ A}$ of negative ion beam with energy 35 keV. The plasma source part including corresponding electrical system, diagnostics, data acquisition & control systems, cooling water, gas feed etc. are already operational. In this year, mandate was to incorporate the accelerator system into the system with upgraded gas feed system, data acquisition and control system (DACS), RF matching unit. Some procurement related activities along with conceptual design of power systems regarding twin source (TS) have also been started. Following are the major activities initiated / completed in this front:

Final acceptance testing of accelerator system of ROBIN ion source at M/s PVA: The final acceptance testing of the



Figure A.2.4.1. Acceptance test of the accelerator system for ROBIN ion source at M/s PVA, Tepla, Germany

ROBIN accelerator system was carried out at the works of M/s PVA, Germany during July 2011 after modifying the cooling water hoses in ground grids. All the vacuum leak tests, pressure tests, high voltage tests, alignment tests etc. were found satisfactory and the accelerator system was ac-

cepted. A photograph of accelerator system during acceptance tests in PVA is shown in figure A.2.4.1. After the acceptance tests, the accelerator system was then transported to IPR.

Assembly of vacuum vessel for negative ion beam experiments : A new vacuum vessel specially made for negative ion beam experiments, has been installed in the negative ion lab. The vacuum vessel has been fabricated by local vendor in Ahmedabad. It is made of SS304 having 1.0 m diameter and ~2.5 m length. The vessel has many dedicated port for different diagnostics e.g. Doppler shift spectroscopy, residual gas analyzer, pressure and measurements etc. It has two ISO500 ports where one 5000 l/s (for Hydrogen) TMP and one >20000 l/s (for Hydrogen) adsorption cryopump are installed with gate valves.

Installation of the accelerator system in ROBIN test bed : The negative ion beam accelerator system has been assembled and installed in the ROBIN ion source test bed, as shown in figure A.2.4.2. A specially made ISO500 gate valve, which

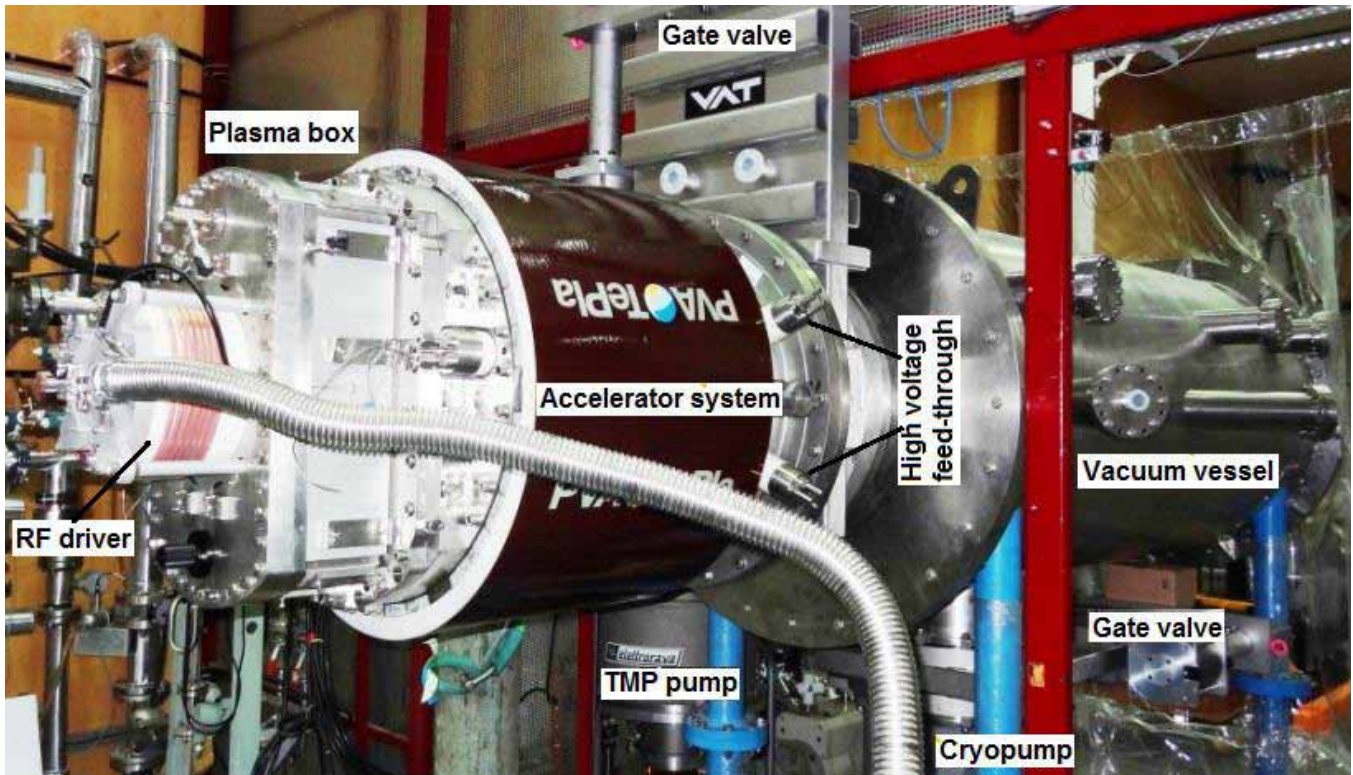

Figure A.2.4.2: ROBIN test bed with plasma box with RF driver; accelerator system, vacuum vessel, TMP, cryopump etc.

can support a cantilever load of one ton of the accelerator and ion source assembly, separates the ion source from the vacuum vessel. The first experiments of the negative ion beam extraction are expected to be started from June 2012. The cesiated source is expected to deliver a negative hydrogen ion beam of 10A with 35 mA/cm² current density at an acceleration voltage of 35 kV.

Commissioning of mass flow controller based gas feed system : A new mass flow controller (MFC) based gas feed system has been commissioned in a dedicated rack to supply hydrogen gas into the ion source. The MFC is operated/controlled by PLC to setup the desired source operation pressure and puff pressure when the plasma is ignited. To avoid the RF induced errors in the MFC, the MFC is shielded properly. The typical operation pressure of the source is 0.4 – 0.8 Pa and the puff pressure is 1.4 – 2.0 Pa. During beam operation, the gas feed system is kept at ground potential by having 50 kV isolators in between the source and gas feed system.

Calorimeter for negative ion beam dump/diagnostic : A copper calorimeter having a series of vertical and horizontal cutouts for thermocouple fixation has been fabricated for negative ion beam dump and beam power and profile diagnostics. The calorimeter is having a serpentine copper tube brazed at the backside of the plate to pass the cooling water and is equipped with ~30 nos. of K-type thermocouples to measure the temperature rise following the beam dump on it. By analyzing the temperature profile, the beam profile, beam power and beam current estimations can be done. The fabricated calorimeter and a schematic of beam power analysis technique considering Gaussian beam profiles along both horizontal and vertical directions

DACS related Activities: For the extraction phase experiment, there is an activity for up gradation and dummy testing of the PLC control program. Corresponding GUI has been done for the upcoming extraction phase experiment. In-house manufacturing, installation and dummy testing of various types of Fiber optics Links (TX-RX) has been done for interconnection of control, monitoring and acquisition signals between the ROBIN DACS and various sub-systems that are floated at high voltage. Apart from these the following developments are carried out.

Development and interfacing of Signal Conditioning Electronics (SCE) for various diagnostic systems for ROBIN:

(A) SCE cards for Pin probes and RF Compensated Langmuir Probe: In ROBIN system for measurement of various Plasma parameter i.e temperature, density, top and bottom edge etc, 2 nos. of pin probes and 1 no. RF Compensated Langmuir Probe, are used. For provide proper signal conditioning, isolation and interfacing to ROBIN DACS (Data Acquisition and Control System) , for the voltage and current signals of these diagnostics, SCE cards with the Fiber optics transmission-receiver (TX-RX) circuit has been design and developed in house , also installed and tested with actual plasma parameters during last plasma operation champing. For the Langmuir probe -40Vdc to +60 Vdc ramp generator circuit is used. All the SCE cards, ramp circuit and power supplies required for these diagnostics are placed in a one rack which will be floated at ~ 35 kV DC during the beam generation experiments. Therefore proper care has been taken for the placement of the all the SCE cards, ramp circuits etc into the rack and rack itself is also be placed on the G-10 sheet.

(B) SCE cards for Calorimeter diagnostics: In order to study the beam uniformity and extracted ion current density, a calorimeter having 32 nos. K-type thermocouples will be used in ROBIN setup. For data acquisition and interfacing of 32 nos. calorimeter thermocouples signals with the ROBIN DACS, a SCE card having 8 channel fiber optics transmitter circuits with low pass filter and pre-amplifier, has been developed in-house and tested for flowing specification :

- (i) Input differential signal range: (Thermocouple K- type
- (ii) Output signal type: light (frequency range 2.3 kHz to 50 KHz (settable accordingly I/p temperature range)
- (iii) Bandwidth: DC - 1kHz (flat response)
- (iv) Accuracy: 0.5 %
- (v) Rise time = 210 μ S , Fall time= 200 μ s , Delay = 32 μ s
- (vi) Power supply: 24 Vdc

Total 5 nos. (4 nos. for 32 thermocouples + 1 spare) SCE cards are developed in-house, tested and installed. All the Frequency Modulated (FM) light output signals of the calorimeter SCE cards are connected to the rack for fiber optics receiver at ROBIN DACS side through plastic fiber cables.

Design and procurement of Control, Data acquisition and Communication system for the Twin Source experiments:

Twin Source - An Inductively coupled two RF driver based 180 kW, 1 MHz negative ion source experimental setup is initiated at IPR, Gandhinagar, with the objective of understanding the physics and technology of multi-driver coupling. For cater the requirements of a central system to provide control, data acquisition and communication interface to Twin Source experiments, an ITER CODAC technology based control and data acquisition system referred to as TS-CODAC, has been design. In TS-CODAC system, complete control of the experiments will be done by PLC S7-400 (Siemens make system) through 150 Analog and 200 digital control signals, and PXIe based DAQ (Data Acquisition) system will be used for acquisition, online monitoring and post analysis of 152 essential parameters like voltage, current, frequency, RF power, temperature, pressure, flow etc. Requirements and specifications for the various Hardware and software components (viz PLC system, PXIe system, Workstations, various electronics components for in-house development of fiber optics links, Racks, Analog isolation amplifier modules etc) of the TS-CODAC has been generated and major procurement Indents are already raised.

Electrical activities: For extraction and acceleration of negative hydrogen beam from ROBIN source the following electrical activities are carried out:

Implementation of remotely tunable system for matching network :A stepper-motor based remotely tunable system has been successfully installed and commissioned on the RF matching circuit. The desired matching parameters are settable through a touch-screen HMI specifically programmed and configured for the experimental requirements. Special considerations have been taken to isolate the system from HV and RF noise.

Procurement of 2MVA, 11/0.433kV distribution transformer : A 2MVA 11/0.433kV distribution transformer has been procured to cater the input AC power needs of the HVPS system. The transformer is designed by M/s PETE Hyderabad and has been subjected to various routine and type tests at factory and CPRI. The acceptance tests are successfully conducted at IPR also. The site for its final installation and commissioning is presently under construction.

Procurement of 2MVA LT Main distribution panel and copper bus-duct : ACB based 2MVA LT Main distribution panel and a TPN copper bus-duct of similar capacity have been procured for distributing the power from the 2MVA transformer to the HV power supplies. The system is designed by M/s Laxmi Engineering Pvt. Ltd. Ahmedabad and has been subjected to various routine and type tests. The acceptance tests are successfully conducted at IPR. The site for its final installation and commissioning is presently under construction.

Procurement of HT, LT and control cables : High voltage power cable and LT power cable have been procured for transmitting the AC power for on 11kV side of the transformer and the LT power from the LT Main distribution panel. For the control wiring of the transformer (with the HT panel) a multi core control cable as also been procured. The cables are manufactured by M/s Polycab Cables Pvt. Ltd. and have been subjected to various routine and type tests.

Implementation of new cable tray scheme for carrying HVDC power : A new cable tray scheme has been implemented in the negative ion lab to carry HVDC power from the single HV power supply (EPSS: 11kV, 35A HVDC power supply) to the source. The new scheme has evolved as a requirement for short time installation of the EPSS within the lab and conducting low power extraction experiments. Due to constrains in the existing space, the supports for the trays have been taken from the ceiling of the utility building through specially designed chemical anchor fasteners. Insulated fiber-glass trays have been implemented for isolation purpose.

Development of HVPS system for the -ve ion source : The high voltage power supply system for the negative ion system has made significant progress in development and is in its advanced stage of manufacturing at M/s Veeral Control Pvt. Ltd. Gandhinagar. Preparations are on for the factory acceptance of the first power supply (11kV, 35A). Exhaustive follow-ups and stage wise inspections have been conducted to ensure technical conformity and quality. For twin source (TS) experiment floor layout in INTF building has been done. Conceptual design of electrical systems, transmission lines etc. for this experiment have been carried out and few procurement activities for power supplies are initiated.

A.3. Basic Experiments

A.3.1. Large Volume Plasma Device (LVPD)

Investigations are carried out in LVPD mainly on two fronts. In the first scenario, significant progress is made in identifying the observed turbulence as Electron Temperature Gradient (ETG) driven turbulence. The efforts were directed to prove it as first unambiguous laboratory observation. In the second scenario, investigations on the characterization of extremely low beta plasma confined, within the large Electron Energy Filter (EEF), sandwiched between two high beta plasmas is under progress. In this region investigations are underway to understand the plasma transport by unfolding the nature of turbulence. The presence of EEF makes this region extremely important for transport study.

ETG turbulence

We reported first laboratory observation on ETG turbulence in plasma devoid of energetic electrons by making use of an extremely large, 2m diameter electron energy filter (EEF). As most of the laboratory plasmas are contaminated by the problem of energetic electrons and the measurements made of electron temperature by using Langmuir probes is usually considered as ambiguous because of these electrons. This poses a serious problem for the interpretation of results where the measurement of electron temperature and its gradient, the very source of free energy for the ETG turbulence becomes doubtful. In LVPD, this ambiguity is removed by the EEF as most of the energetic electrons are scavenged by its magnetic field. The EEF divides the LVPD plasma into

three regions i.e., the source, filter and target regions. The investigations for ETG study are carried out only in the target plasma. The target plasma is devoid of energetic electrons and an experimental verification of this is provided by comparing the measurements made for electron temperature using Langmuir probes with the estimated values obtained by using separately measured values of floating and plasma potentials. A close agreement is observed between the radial profiles of electron temperature obtained by the two methods [see Figure A.3.1.1]. This validates the measurement of electron temperature and confirms that the target plasma is devoid of energetic electrons. Although, EEF is capable of producing different plasma profiles for its different fields but we have chosen two extreme possibilities in which 1mx2m extent of EEF is active and another where EEF remains inactive. The plasmas in the two cases are defined as one having flat density and gradient in temperature (FneGTe) and second hollow density and flat temperature (HneFTe). We have presented results for both cases and it can be seen from the figure that active EEF exhibits no effect of poisoning whereas, the in the inactive EEF case, as no transverse field is there, the deviation between the two profiles becomes visible. This shows that because of the leakage of energetics to target plasma in EEF inactive case, the measurement gets poisoned. Investigations are further carried out for the validation of observed turbulence as ETG. We have demonstrated successfully that electron temperature fluctuations are excited when finite gradient is established in radial profile of electron temperature. In our case, this situation was obtained only in the case when the EEF is activated. Whereas, when EEF is dormant, the electron temperature profile becomes flat and no fluctuations are exhibited in electron temperature measurement. Evidence towards confirmation of ETG is pro-

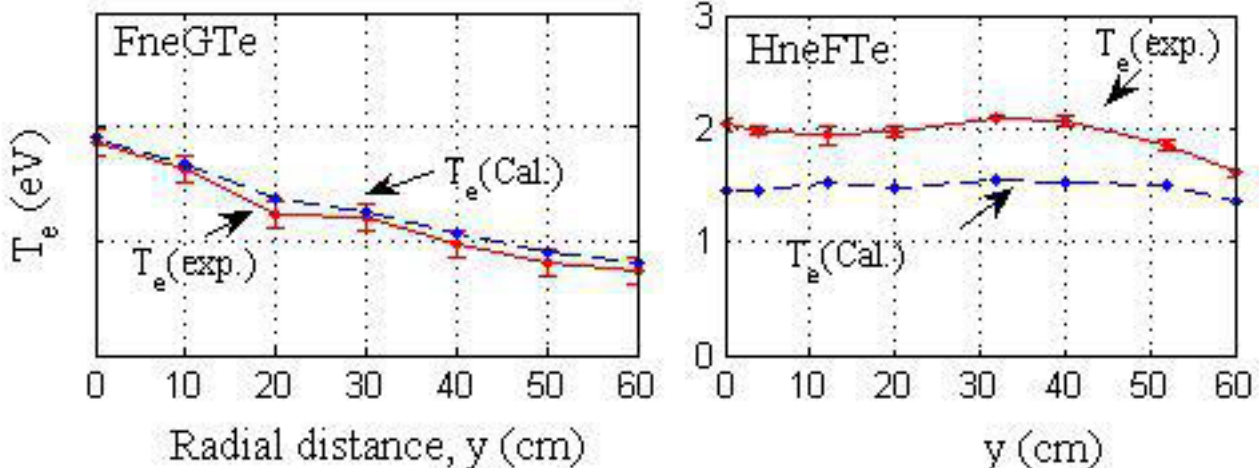

Figure A.3.1.1: A comparison of electron temperature in hollow and flat density plasma with EEF active (FneGTe) and inactive (HneFTe) respectively

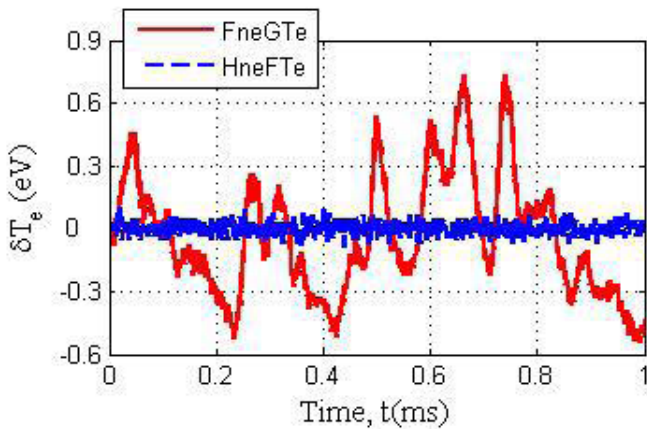

Figure A.3.1.2: Comparison of electron temperature fluctuations with flat density (FneGTe) and hollow density (HneFTe) plasma is shown in the figure. It is clearly seen that the temperature fluctuations are excited only when gradient in electron temperature is there.

vided by the observations made of electron temperature fluctuations in the two scenarios. A novel method of two probes is developed to perform these measurements. This technique is tested against a well-accepted method of fast swept Langmuir probes used for temperature measurements. As the two-probe method provides direct measurement of mean temperature and its fluctuations so this method is preferred in LVPD over the conventional fast swept method. Excitation of electron temperature fluctuations itself is a wonderful proof for the validation of the observed turbulence as ETG. Figure

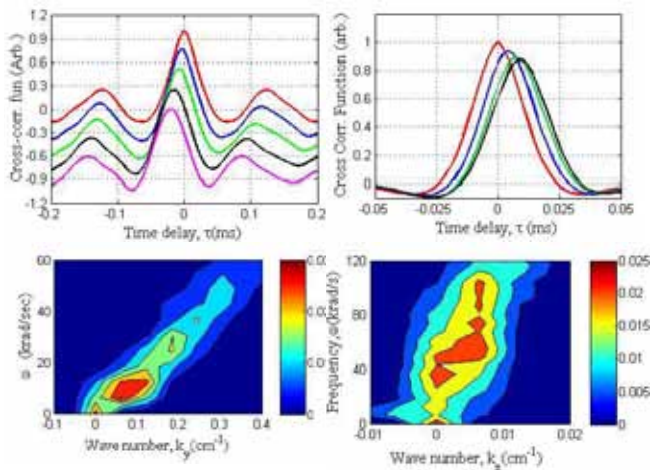

Figure A.3.1.3: The cross-correlation function and the contour plots of the joint wave number spectra for normalized density fluctuations are shown for both the parallel and perpendicular direction. The data is taken for $R=30$ cm and applied field of 6.2G.

A.3.1.2, shows the temperature fluctuations obtained in the two scenarios.

Although, a brief description of the observed mode, propagating in azimuthal direction was presented in last year report but validation of it as an ETG mode by comparing it with the parallel mode number was not completed. We investigated the parallel propagation of the observed turbulence and compared the perpendicular and parallel wavenumber of the observed mode. As shown in figure A.3.1.3, the parallel wave number obtained for the observed turbulence is approximately 0.008 cm^{-1} , a significantly smaller number than the perpendicular wave number. The ratio of k_y/k_z becomes $\sim 2 \times 10^{-2} \ll 1$. This agrees well with the linear theory of ETG and thus provides validation to the observed turbulence as ETG turbulence. Presently, investigations are in progress for unfolding non-linear features associated with ETG in large volume plasma device. During this time, large engineering efforts were put in the development a 5 kA current rated, pulsed power supply with fast turn on/off for energizing ~ 275 G in EEF in LVPD. The heart of this supply is a static switch which consists of 10 IGBTs, connected in parallel for the pulse switching of maximum of ~ 5.3 kA [see Figure A.3.1.4]. It rapidly sources 75 Coulombs available with a 200V capacitor bank of 2.77F. Power supply is made robust by (1) ensuring equal current sharing and uniform power distribution during the pulsed operation of the IGBTs, and (2) a safe commutation of power for ~ 9.5 microH inductive load of EEF by proper optimisation of power stack inductances, and making use of suitable snubber circuits for additional protection. This allows voltage protection against anticipated back emf in excess of 6 kV at turn off. The switch is operated on command and is electronically timed using an optically isolated computer controlled interface for both pulse width

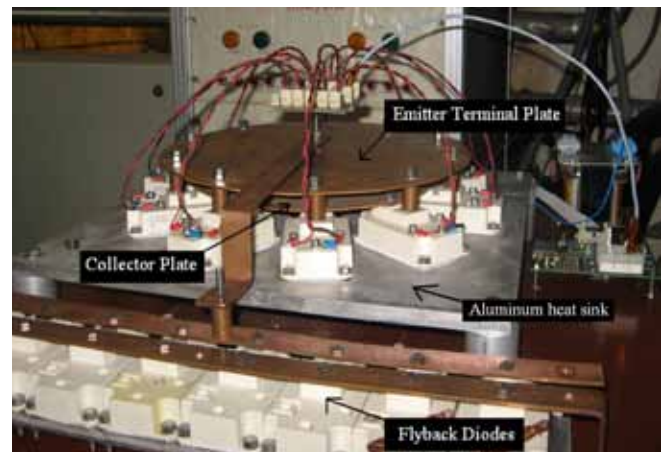

Figure A.3.1.4: The photograph of IGBT based compact 5 kA capacity static switch.

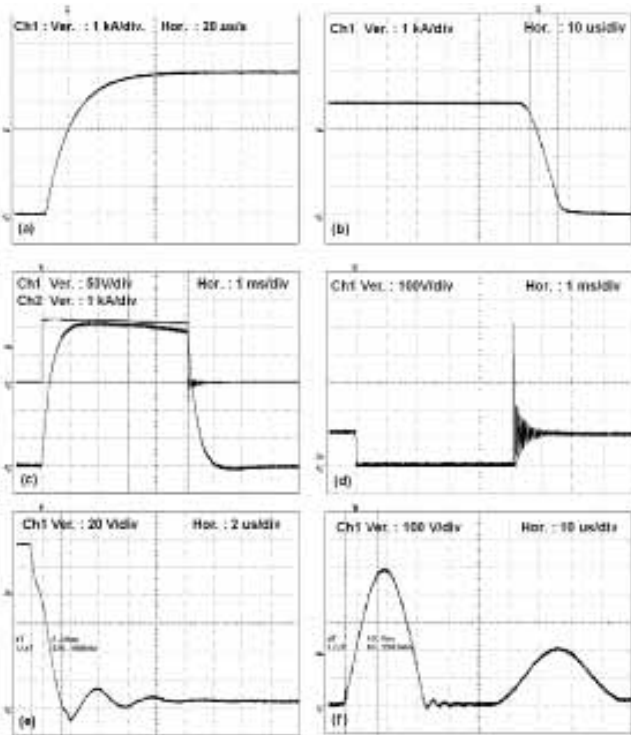

Figure A.3.1.5. The switching characteristics of power supply on resistive load are shown in (a) rise time ~ 41 microsec, (b) decay time ~ 9.4 microsec and on EEf load are shown in (c) a test shot of voltage and current pulse of 5 ms, (d) evolution of V_{ce} during the switching operation. The figure shows in (e) the expanded form of switch during turn on and in (f) the V_{ce} peak at turn off.

and pulse repetition frequency of ≤ 1 Hz and duty cycle ≤ 0.015 percent. The power supply has specifications of: Rise time ~ 41 microsec (resistive load) and, decay time ~ 9.4 microsec, pulse duration with flat current ~ 12 ms, current droop over the pulse duration less than 20% and terminal voltage ≤ 150 V[see Figure A.3.1.5]. Extensive computation and simulation was undertaken for selecting the most optimised and rugged topology. Till date, the power supply has pumped more than 20,000 shots, which corresponds to more than 1.5×10^6 Coulomb of energy on to the EEf load without any failure. Work is in progress to improve the droop percentage of this supply.

Low Beta Plasma Sandwiched between high beta plasmas :

Installation of rectangular solenoid type Electron Energy Filter (EEf) at the centre of the system has divided LVPD plasma into three distinct experimental regions, namely, source, filter and target region. The EEf is responsible for producing a strong (~ 250 G) transverse magnetic field perpendicular to

the applied axial field and it makes the plasma beta in the region extremely low compared to the beta values in the source and target region. The region near the EEf is chosen for the present investigations. A brief description on basic plasma characteristics like electron density (n_e), temperature (T_e), floating potential (V_f), plasma potential (V_p), and the fluctuations in electron density along the axis in the three regions has been made in last year report. This year investigations are restricted axially in the target region within 12 cm from the edge of solenoid wires. The axial measurements of the plasma parameters have shown a gradient across the EEf (filter region), i.e. the electron density drops by an order, floating potential becomes more positive, electron temperature falls from 3.5 eV to 1.5 eV, and plasma potential becomes more positive in the target region as compared to the source region. Density fluctuations in the source region are found to be negligible in comparison to the target region. It gradually increases from source to target (10-12 %) through EEf (3-4 %) and the turbulence exhibits peak power in the frequency range of 2-30 kHz in filter region and less than 10 kHz in the target region[see figure A.3.1.6]. The turbulence in the filter region is termed as low frequency ($f_{ci} > f_{tur}$) whereas in target region, it is categorized as high frequency ($f_{ci} < f_{tur}$). The power spectrum exhibits a broadening in comparison to the filter region. The cross correlation between the density and potential reverses its sign from negative to positive while moving from filter to target regions. Enhanced density fluctuation observation in the target region near EEf raises issue regarding driver mechanisms involved for the observed instability. Experimental observations thus exhibits a signature of reverse cascading of energy from high to low frequency modes but confirmation of this requires further investigations. In this direction steps are being taken to analyse this data through Empirical Mode Decomposition (EMD) technique. We investigated turbulence in the near EEf region by looking for the identification of free energy source associated in the region. Mean plasma profiles obtained in the near EEf target region ($\Delta z=12$ cm and $\Delta y=40$ cm) from the surface of EEf. It presents an interesting scenario. The region exhibits no gradient in the radial profiles of electron temperature but sharp gradients are observed in electron density and potential profiles. An electric field, $E_y \sim 16$ V/m is produced in the radial direction. Investigations are undertaken for propagation characteristics in axial, azimuthal and radial directions by using correlation and joint wave number frequency analysis techniques. The mode is found to propagate away from the target region with a typical phase velocity, $V_z \sim 6 \times 10^5$ cm/s[see figure A.3.1.7]. Most of the power of these fluctuations resides within 10 kHz with typical wave number, $k \sim 0.05$ cm^{-1} . The observed frequency lies in the lower hybrid regime. The radial propagation velocity of the observed turbulence

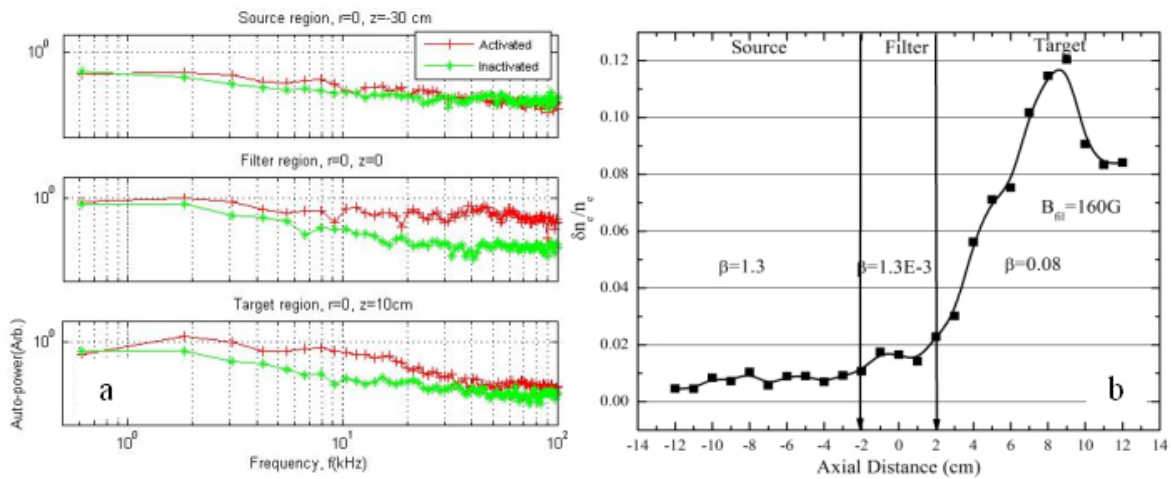

Figure A.3.1.6: (a) The power spectra of density fluctuations in the three regions are shown in the figure. The power spectra in the target region exhibits broadening of frequency spectra. The axial profile of the normalized density fluctuations in near vicinity of EEF shows an increase in the level of fluctuation in the target region.

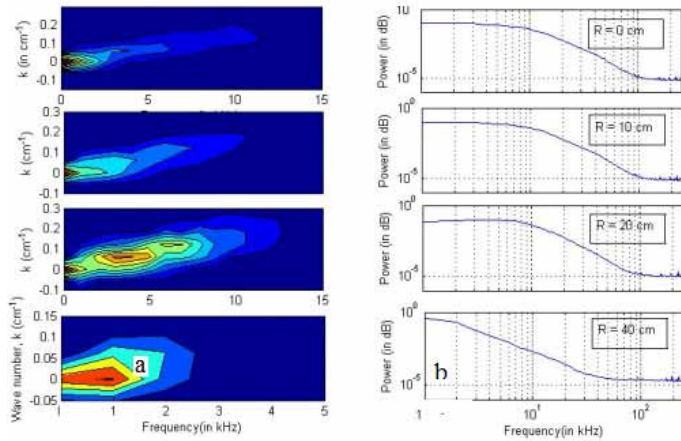

Figure A.3.1.7: The contour plots and the frequency power spectra of the normalized density fluctuations are shown at different radial locations at $z=10$ cm from the EEF surface. The figure shows distinct propagation with phase velocity $\sim 6 \times 10^5$ cm/s axially away from the filter. It shows significant reduction beyond $R=30$ cm. The power of the observed turbulence lies within 10 kHz in the region.

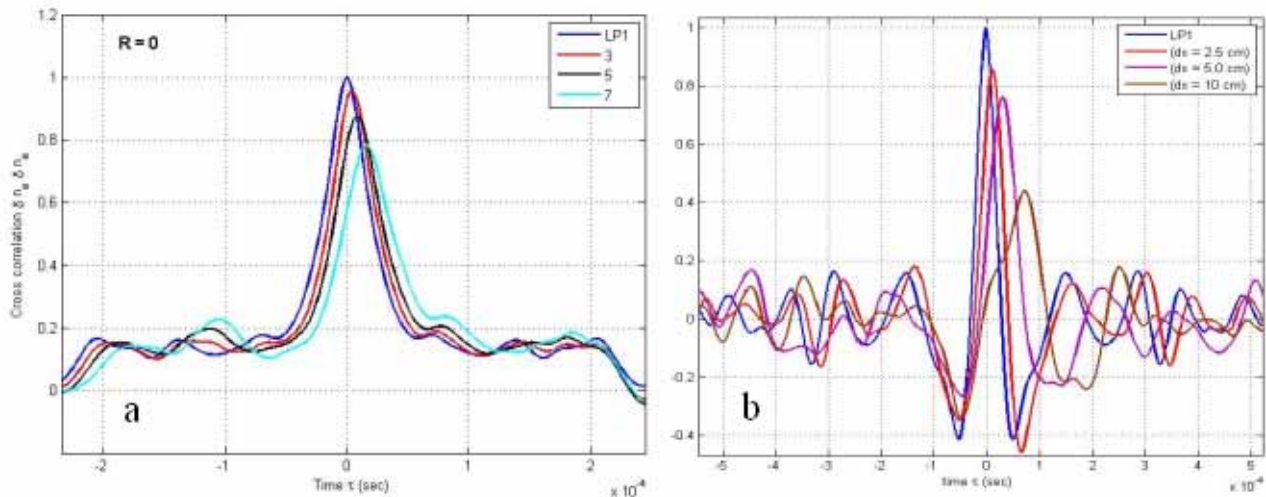

Figure A.3.1.8: The cross-correlation function for the normalized density fluctuations for (a) axially and (b) radially separated probes. It is observed that the axial propagation velocity of the mode exceeds its radial counterpart by approximately seven times.

is $\sim 8 \times 10^4$ cm/sec and is in the outward direction. Observation shows that $V_z \geq 7V_y$ [see figure A.3.1.8]. Similarly, mode is also found to propagate in azimuthal direction with propagation velocity, $V_x \sim 10^4$ cm/sec. The observed velocity is found comparable to the ion diamagnetic drift velocity and the direction propagation direction is along the ion diamagnetic drift direction. It is also observed that the electron diamagnetic drift velocity is comparable with the ion sound velocity. Study for the identification of the mode is underway. The results obtained in near EEF region are summarized as follows. The region is dominated by the low frequency turbulence with $f_{tur} < f_{ci}$ with region having electric field parallel to the density gradient, the ion-neutral collision frequency is found to be close to the ion cyclotron frequency. The electron neutral collision frequency is found to be smaller to the electron cyclotron frequency. A possible candidate defining the observed turbulence may be the Simon-Hoh instability. Observation also shows that the turbulence exhibits propagation in all the three directions but the dissipation of power is observed mostly in the radial direction. The observation of high frequency in the filter region and narrowing down of its band raises the possibility of a low frequency mode conversion. Work on providing a theoretical explanation to this is under way. We have demonstrated in the section of ETG turbulence that target plasma is free of energetic electrons but how these energetic electrons are losing their energy and getting lost in the device is not understood. We have now initiated experiments to trace the whereabouts of these energetic electrons emitted from the heated filaments in LVPD. Detailed investigations to trace the trajectory of these energetic electrons are in progress. These observations may also be correlated to the phenomena similar to the formation of radiation belts close to 4-5 RE in space (Earth radius) and particle acceleration in the source and filter region. Further, the trajectories will be more useful with trapped energetic electron mode studies.

A.3.2. Basic Experiments in Toroidal Assembly (BETA)

Experimental study of generation of fluctuations-driven flow in and mean profile sustenance : Experimental investigation of fluctuation-flow mechanisms has been carried out in the simple toroidal device BETA. The fluctuation induced flux has been found to play a crucial role in the generation of an “effective rotational transform”, which otherwise would not exist in a simple toroidal plasma, theoretically. In first set of experiments, varying the discharge conditions, existence of large fluctuations accompanied by significant poloidal flows has been observed in the Argon plasma at a toroidal magnetic field of 220 G. Highly coherent fluctuations are found to exist when the discharge current is limited to 5 A. Due to the significance of na-

ture of fluctuations in generating poloidal flows, nature of the fluctuations has been varied by changing the magnetic field strength or ion mass by choosing the heavier atomic gases for discharge. In the second set of experiments, increasing the toroidal magnetic field strength, from 220 to 440, and then to 660 G, transition to turbulence accompanied by enhanced confinement has been observed. The nature of turbulence has been characterized by using spectral analysis techniques. In the third set of experiments, increasing the ion mass, by choosing Argon, Krypton and Xenon gases for the discharge, again transition to turbulence has been observed; however, poloidal flow velocities are found to reduce with increase in ion mass.

A.3.3. Interaction of Low Energy Ion and Neutral Beams with Surfaces

Low energy (1-100 eV) ions and neutrals are the active species in many physical and chemical processes. For example, in plasma processing both ions and active neutrals (radicals) are responsible for the growth of thin films (plasma CVD) and also in diffusion coatings (plasma nitriding, etc.). In space, an orbiting satellite at low earth orbit (LEO) is bombarded with 5 eV (“hot”) O atoms which severely erode its surfaces. In fusion devices, wall materials are sputtered by particles with energies which range from tens of eV’s to hundreds of eV’s. Hence it is desirable to study such reactions in controlled laboratory environment, i.e. interaction of surfaces with ion / neutral beam of specific energy (low energy spread). It is with this objective a microwave based pulsed plasma / neutral beam set-up has been developed. The plasma source consists of a stainless steel tube of 26 mm internal diameter and length 134 mm. Microwave power (1 KW) is coupled to this source from a pulsed microwave power supply via a coaxial antenna (SS) of diameter 5 mm. The discharge frequency, on-period and off-period are all adjustable. Presently we are using 500 Hz with a duty cycle of 50%, thus an average of 500 W is being used. The whole plasma source is immersed in an axial magnetic field (400-500 Gauss) produced by a pair of Helmholtz coils. The threshold value for plasma generation is 390 Gauss. The plasma particles travel towards a reflector plate in a “beam” form (diameter 26 mm) with the help of the axial magnetic field. The neutral beam is produced as a consequence of charge neutralization (of ions) at the biased reflector plate. The plasma beam (nitrogen / hydrogen discharge) has been characterized for its density across the beam. The density is 1.1×10^{12} cm⁻³ at the centre, 5×10^{11} cm⁻³ at 4 mm from the centre and 1×10^{11} cm⁻³ at 9 mm from the centre. The total ion current collected by the biased neutralizer plate is approximately 60 mA. We are in the process of treating steel samples of various grades with ion (plas-

ma) as well as neutral beams. An investigation was carried out for the surface treatment of SS201 material (diameter 16 mm) using the high density plasma beam source (gas mixture N₂:H₂=1:2) at a low temperature of 400°C for 1 hour. The surface hardness achieved is rather high (1900 HV) which is more than five-fold increase compared to untreated surface (358 HV). The depth of the nitriding layer was found to be 26 microns. XRD results indicate efficient conversion of chromium to chromium nitride by the high plasma density of the present source accounting for the very efficient nitriding process. The high surface hardness and case depth achieved at 400°C (1 hour treatment time) in the present investigation has never been achieved with any other source previously, where the plasma density is at least an order lower. These results led us to conclude that the efficiency of the nitriding process is related to the plasma density, i.e. more the plasma density more efficient the nitriding process is specially at low temperatures. A more energy efficient electromagnet has been designed and is being fabricated presently in a local company. The new electromagnet when ready (July 2012) will allow us to increase the magnetic field from present 450 Gauss to 1500 Gauss without increase in electrical power. Since the plasma density for such plasma systems varies as square of the magnetic field, it is expected that the plasma density (hence the flux) will be increased by a factor of ten.

A.3.4. System for Microwave Plasma Experiments (SYM- PLE)

This project aims at studying the interaction between plasma and high power microwave (HPM). The developmental work on HPM, using VIRCATOR (Virtual Cathode Oscillator) and a plasma system based on washer gun had been taken up at different laboratories. These two systems have now been brought together in a shielded enclosure installed in the newly allotted laboratory. While improvisation of these two units to attain the critical parametric criteria is still under way, work towards their integration has also been taken up. The present report discusses the major results.

System integration : Figure A.3.4.1. shows the VIRCATOR and the plasma systems prior to coupling. The plasma system is four – gun based. The design of the coupler is depends critically on the nature of the HPM output in terms of power, frequency and mode structure, experiments on which is presently being carried out.

VIRCATOR improvisation : The initial version of the VIRCATOR, constituted a pulse power system delivering about 5 GW input pulse power to the diode. Expanding this work, we have installed a plasma opening switch (POS) in the pulsed



Figure A.3.4.1 the VIRCATOR and the plasma systems prior to coupling



Figure A.3.4.2 Plasma Opening Switch

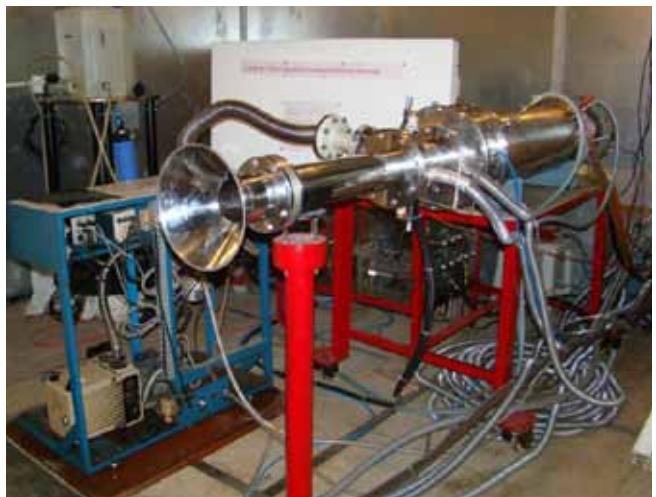

Figure A.3.4.3 the VIRCATOR system with Plasma Opening Switch installed.

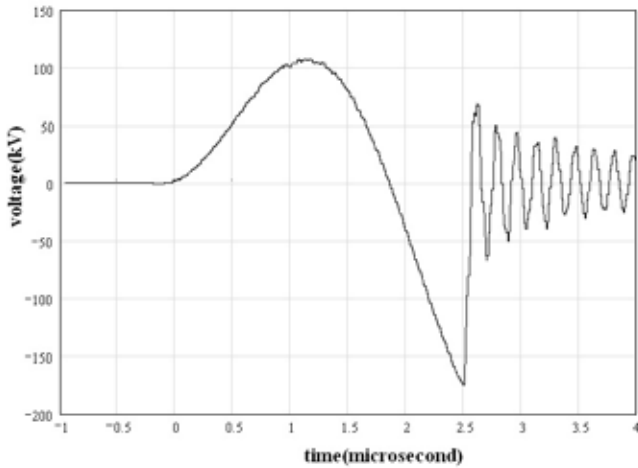

Figure A.3.4.4 The voltage at the end of pulse forming transmission line.

power unit that acts as a very fast opening and high current switch. The POS is shown in Figure A.3.4.2. Here, plasma is injected into the switch, which carries a large conduction current, before it opens in a process that lasts for a few nanoseconds and transfers the current to a parallel-connected load at a much increased voltage and with a much shorter rise time. The conduction and opening times of the switch are dependent on plasma parameters such as the distribution, speed and species, all of which are determined by the plasma source. Shown in Figure A.3.4.3 is the VIR-CATOR system with POS installed. The voltage at the end of pulse forming transmission line is produced in the figure A.3.4.4. The corresponding diode current obtained prior to and after the incorporation of the POS (with no plasma produced) is compared in Figure A.3.4.5. For shots carried out with plasma in the POS, the pulse compression is clearly visible, as shown

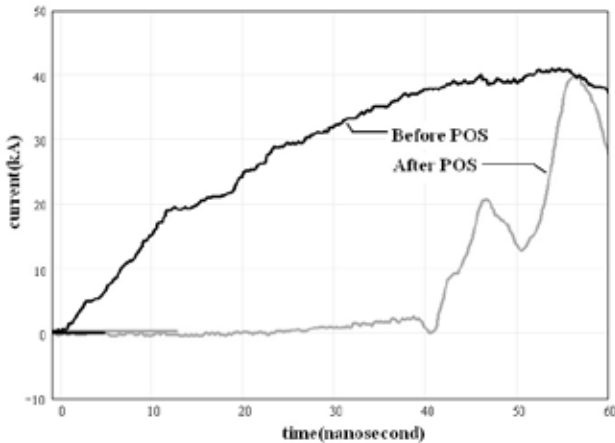

Figure A.3.4.6 Comparison of diode currents with plasma.

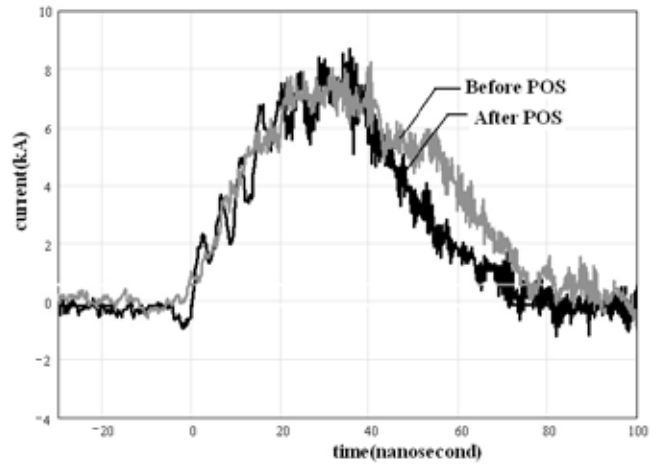

Figure A.3.4.5 Comparison of diode current obtained prior to and after the incorporation of the POS (with no plasma)

by the red curve in Figure A.3.4.6. A compression ratio of ~ 3.5 is obtained (rise time without POS = 56 ns and with POS is 15.8 ns). With the introduction of POS, the input power of about 20 GW can now be delivered to the cathode which is about 4 times the power delivered without use of POS.

HPM Characterization : The characterization of the VIR-CATOR without the POS installed is presently being carried out. The output is measured using a receiving antenna, either through a diode detector (a typical plot is shown in Figure A.3.4.7.), that gives the total power output, or by directly acquiring the antenna output on an oscilloscope. The output obtained is wideband, with the power distributed over frequencies in the range 2 – 16 GHz. The dominant peak at ~ 8 GHz, indicates a power of about 100 KW at this frequency.

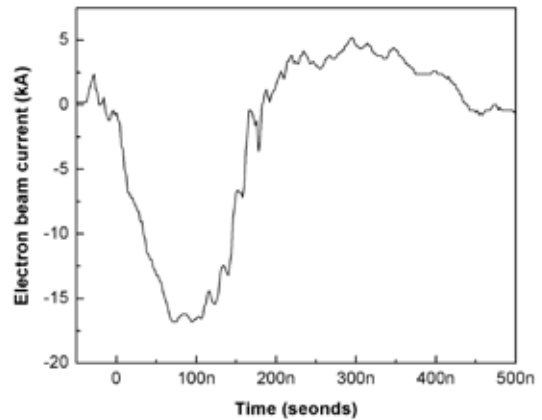

Figure A.3.4.7 The output through a diode detector from the receiving antenna.

A.3.5. Plasma Wake-Field Acceleration Experiment (PWFA)

With the heat pipe oven tested successfully over many months for temperature stability, the study and optimization of the Li vapour in the heat pipe oven was carried out during this period using white light as well as UV laser absorption studies. Temperature and buffer gas pressure dependency of the neutral density of Li were studied in detail. Values of the line integrated neutral density of Li (noL) were found to be of the order of 10^{17} cm^{-2} in the oven temperature range of 600-800°C which are sufficient to obtain the required 10^{13} to 10^{14} cm^{-3} plasma densities by photo ionization for the PWFA experiment. The first photo-ionized plasma of the Lithium vapour was also obtained during this period and preliminary spectroscopic studies of the plasma emission lines at 610 and

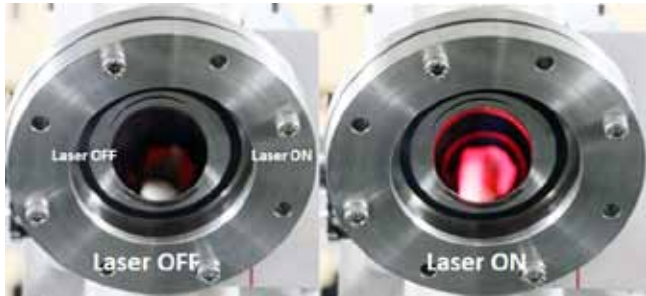

Figure A.3.5.1 Photo of the 193nm laser produced photo-ionized Li plasma showing the predominant 610 nm Li-I emission. The 670 nm emission is re-absorbed by the neutrals in the oven as the neutral density increases with oven temperature. The glow in the Laser OFF photo is of the hot SS mesh in the oven which holds the Li.

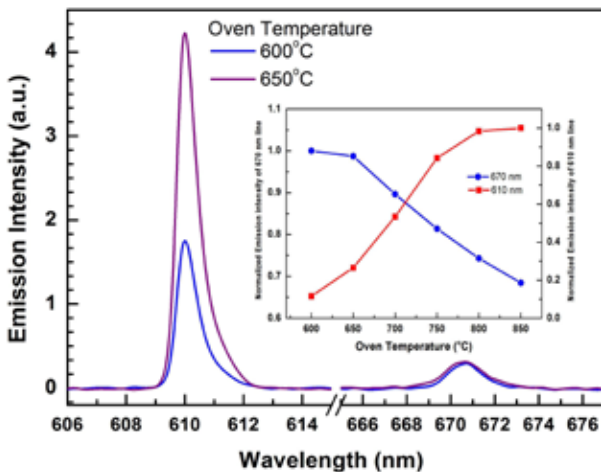

Figure A.3.5.2 The emission spectrum of photo-ionized Li. The dependency of the intensities of the 610 and 670 nm line on oven temperature is shown in inset.

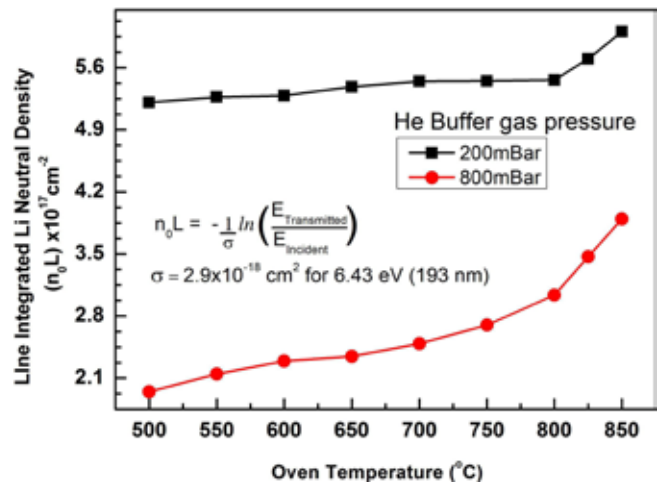

Figure A.3.5.3 The dependency of the line integrated Li neutral density on oven temperature and buffer gas pressure measured from UV absorption.

670 nm were studied using the low resolution spectrograph. As a calibration for the lithium vapor density and eventually the electron density, the dependency of the ratio of the above line intensities on the oven temperature is currently being studied. It can be seen that the 610 nm line intensity grows with temperature while that of 670 nm decreases. The Since Li has a strong absorption in the 670 nm region there is strong re-absorption of the 670 nm emission which is also observed in the white light absorption studies. Preliminary results show a linear dependence on temperature and hence neutral density. Both these experiments are currently being carried out with a low resolution spectrograph and will be repeated to validate the results using a high resolution spectrograph when the device is obtained in a month's time. The components for the CO₂ laser interferometer measurement of the plasma density are under process of procurement. Preliminary interferometry studies of plasma density using white light is planned to be undertaken soon. Major part of the integration and remote operation of experimental devices such as laser, oven temperature control & monitoring, white light source, buffer gas fill etc. using LabView has been completed. The testing of the control of the excimer laser using the remote control software is currently underway.

A.3.6. Experimental study of non-linear plasma oscillations

The aim of the experiment is to study phase mixing and wave breaking of non linear plasma oscillations. The experimental requirement for studying the above mentioned phenom-

ena has been determined and accordingly the experimental set up has been designed. The experimental device consists of vacuum vessel, electromagnets and plasma source. The vacuum vessel for the first phase of operation is ready. We have achieved a base pressure of 6×10^{-4} torr using a diffstak. As far as the electromagnets are concerned there are two sets of electromagnets. One set of electromagnets is the primary magnets which is being made from copper tubes. These magnets will be in the form of double pancakes. It is capable of producing a DC magnetic field of 720 G and more over a 1.4m distance with ripple less than 1%. The total magnet fabrication system for making these double pancakes has been designed and made in the institute. The first double pancake has already been manufactured using this system. Considering the fact that, it was taking a lot of time to make these double pancakes. As the work involved procuring copper tubes, designing and fabrication of magnet fabrication system. A set of 10 electromagnets were made using copper wires with limited capabilities to start our experiment at the earliest. The performance of these magnets has been found to be satisfactory. These electromagnets has already been integrated with the vacuum system. The plasma source consist of filaments in the presence of cusp magnetic field. The cusp magnetic field will be produced by locally procured permanent magnets. All the components necessary for making the plasma source has been procured and fabricated. Currently we are assembling the plasma source. The plasma source is expected to be ready for operation soon. The initial plasma diagnostics is also ready for operation. We are expecting the first plasma along with data very soon.

A.3.7. Experiments on Dusty Plasma

Broad objectives of the experiment is to study the effect of dust compression on the neighbouring plasma and the dust rotation in the presence of magnetic field. If one confines these dust particles locally, the particles will mutually repel each other (because of the same nature of the charges present on them) and the resulting repulsion is like an effective pressure or electrostatic pressure. Prof K. Avinash in his Plasma Heat Engine theory has shown that the expansion/compression of electrostatic fields associated with charged particles can be used to convert mechanical work into plasma heat. We are doing experiments for studying the effect of these electrostatic fields on the surrounding plasma. The dust particles are being assumed to be behaving as ideal gas which means either the dust density should be very small or the particles should be of nano-sized. As we know on compressing an ideal gas adiabatically, it leads to increase in temperature whereas

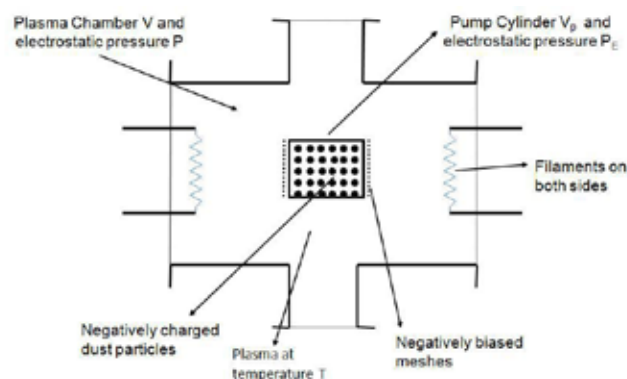

Figure A.3.7.1. Schematic drawing of the system being used for dusty plasma experiment

during free expansion the temperature remains constant. In our experiments, we are interested in determining the change in temperature due to adiabatic compression. The experimental set up consists of the experimental chamber, vacuum system, plasma source and all other things being used in the experiment. We are using a stainless steel cylindrical chamber whose inner diameter is 31cm and length approximately equal to 50cm. It has four radial ports each having a mouth flange of outer diameter equal to 19cm and height equal to 9.5cm above the cylinder. The idea is to make plasma in the whole vessel and then keep another floating cylinder, whose volume has been set as one tenth of the main chamber volume, inside the plasma on the both sides of which two meshes will be attached. The meshes will be given a negative potential wrt to the inner cylinder. The dust will be kept in the inner cylinder. The size of mesh will be such that it does not affect the plasma parameters too much and at the same time it lets the plasma to flow inside the inner cylinder. Argon gas is being used for these experiments. We are using filaments for producing the plasma. Two tungsten filaments are being inserted from each side flanges i.e., a total of four filaments are being used. The diameter of the tungsten wire being used for making filaments is 0.25 mm and the length of each filaments wire is 14 cm. The exposed length of the filament is around 13 cm. The inner cylinder has been mounted at the centre i.e., it is equidistant from both the filament planes. A planar Single Langmuir probe with a voltage sweep is being used for measuring the electron temperature and plasma density outside the inner cylinder (in front of the meshes). Right now we don't have any provision of carrying out these measurements inside the inner cylinder but in future we have some plans to do so. The dust confinement meshes will be given a periodic negative voltage pulse so that it compresses the dust from both sides. The compression is being done adiabatically. The measured electron temperature with the help

of a Single Langmuir probe was found as 1 eV to 2 eV and plasma density lies in the range of 10^9 cm^{-3} . The inner cylinder along with the meshes has been installed inside the main plasma chamber. The electronics for biasing the meshes with respect to cylinder is ready, as well as the RAMP circuit for the single Langmuir probe is also almost ready. When the ion density gradient and electric field present in the plasma make an angle with the magnetic field, it causes diamagnetic drift and $E \times B$ drift on the ions. Because of the electrostatic attraction between the dust particles and ions, the levitated dust clouds follow the ions and start rotating along with the ions. People have done various experiments on dust rotation in the presence of vertical magnetic field. They found dust rotation as a result of the competition between diamagnetic drift and the $E \times B$ drift acting on the dust particles. Also there are experiments where people have studied dust rotation mainly as a result of diamagnetic drift (or one can also say in the absence of $E \times B$ drift) but till now there is no experiment in which only $E \times B$ drift is present and the rotation takes place. So we want to study the effect of only $E \times B$ drift present in the system. At the same time there are no experiments in the presence of radial magnetic field as it is very difficult to produce radial magnetic field. In our experiments we have made some arrangement for producing radial magnetic field both with the help of permanent magnets and electromagnets. Now in this case as the ion pressure gradient will be primarily either parallel or anti-parallel to the magnetic field, there will not be any diamagnetic drift acting on the dust particles. Thus we will be able to see the effect only of the $E \times B$ drift on the dust particles. The second big achievement of this experiment will be that as the magnetic field will be radial so the sheath electric field can be used for the $E \times B$ drift which used to be very strong as compared to the electric field which people have worked. Thus this experiment may be done in the presence of weak radial magnetic field. Experiments will be done in the same chamber as has been described above. The only difference is that hereby we will use RF discharge instead of Filament discharge. The particles will be tracked from the top view port using a CMOS camera. We have got the RF discharge in the absence of magnetic field and without dust particles by applying RF power between two disc electrodes separated by a distance of around 7 cm.

A.3.8. A linear helicon plasma device with controllable magnetic field gradient

Current free double layers (CFDLs) are localized potential structures having spatial dimensions of tens to hundreds of Debye lengths and potential drops of more than local elec-

tron temperature across them. CFDLs do not need a current for them to be sustained and hence they differ from the current driven double layers. Helicon antenna produced plasmas in an expanded chamber along with an expanding magnetic field have shown the existence of CFDL near the expansion region. A helicon plasma device has been designed, fabricated, and installed in the Institute for Plasma Research, India to study the role of maximum magnetic field gradient as well as its location with respect to the geometrical expansion region of the chamber in CFDL formation. The special feature of this machine consisting of two chambers of different radii is its capability of producing different magnetic field gradients near the physical boundary between the two chambers either by changing current in one particular coil in the direction opposite to that in other coils and/or by varying the position of this particular coil. Although, the machine is primarily designed for CFDL experiments, it is also capable of carrying out many basic plasma physics experiments such as wave propagation, wave coupling, and plasma instabilities in a varying magnetic field topology. Machine has become operational. After thorough characterization of helicon-produced plasmas, we attempted to form CFDLs in our device. For detecting the existence of CFDL in our system, we scanned the plasma potential, electron density, and temperature along the axis of the machine using emissive and Langmuir probes. The axial variation of electron density and plasma potential in argon plasmas produced with 600 W of RF power at 13.56 MHz and magnetic field of 280 G in two different fill-in pressures of $1.2 \times 10^{-4} \text{ mbar}$ and $2 \times 10^{-3} \text{ mbar}$ are shown in figure below. The double layer is current free because there is no external current sustaining this potential drop. The thickness of the CFDL is of the order of 700–1300 Debye lengths in our machine. The existence of CFDL in our machine depends on fill-in pressure as they aren't observed in plasmas produced with high fill-in pressures $>6 \times 10^{-4} \text{ mbar}$. Apart from the

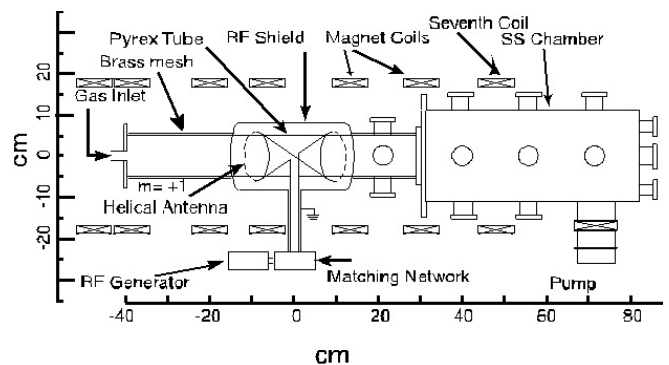

Figure A.3.8.1 Schematic of the Experimental Set up for the helicon plasma device

observation of CFDL, we have also observed plasma density peak at low magnetic field (<100 G), which is believed to be a signature of Helicon and Trivelpiece- Gould wave coupling further confirming the presence of helicon mode in the system. The variation of plasma density with magnetic field in the range of 0 to 100 G measured at axial position of $z = 22$ cm for two different gases (N₂ and Ar) keeping constant pressure and input power of 2×10^{-3} mbar and 350 W, respectively, are shown in figure below. The plasma density peaks at different magnetic fields for different gases with higher magnetic fields required for density peaking in gases with higher mass. A helicon plasma system has been designed, fabricated, and installed with a primary aim of understanding the formation mechanism of CFDL in helicon antenna produced plasmas. The device is fully operational producing helicon plasma regularly over a wide range of fill-in gas pressure, applied magnetic field and RF input power. Plasma density of $\sim 10^{11}/\text{cm}^3$ is achieved by applying RF power up to 1500 W to a half helical antenna with 100 G of magnetic field. Variety of measurements, such as, variation of plasma density and load capacitance with input power as well as the measurement of wave axial magnetic field and radial density profile, confirms the existence of helicon mode in our system. With the application of diverging magnetic field, stable current free double layer is achieved in our machine.

A.3.9. Multi-Cusp Plasma Experiment

An ANSYS based simulation for the chamber with the hot plate ionizer showed that the chamber temperature might exceed 300°C. Then it was decided to have cooling pipes around the reducer between the main chamber and the cesium inventory chamber. The simulation with these additional cooling pipes showed the temperature to be less than <80°C for a realistic flux of cooling water circulation. This was communicated the vendor and the vendor accepted the fabrication without any additional costs. The vacuum chamber inspection was done at the vendor site and some corrective measures have been suggested. The procurement of the various power supplies and feed-throughs are in the final stages. The integration of the experimental system is expected to commence soon.

A.3.10. Laser Blow-off Experiment

In continuation with the experiments related to the characterization of laser induced plasma plume (for the both conventional solid ablation 'LPP' and plasma plume formed by the Laser-Blow-Off 'LBO' technique); we have made several efforts to improve the present experimental and detection

system for more precise study of mechanistic aspects of the change in characteristics of plasma plume due to external disturbance (for example, ambient gas, external magnetic field, probe laser, study plasma, etc.). During this period, it was mainly focused on the characterization of laser induced barium plasma. We have chosen the Ba target because it is important element in space plasma and hence characterization of laboratory Ba plasma helps to understand the various processes in space plasma. Also, the pulsed laser deposition of high-Tc superconductor YBCO film received the great importance in recent years. A detailed investigation of the effect of ambient pressure in the range of vacuum to 20 Torr of argon pressure and an external transverse magnetic field of 6.5 KG on the dynamics and geometrical shape of the laser produce barium plasma plume has been carried. Apart from the enhancement in the plume intensity, duration and change in shape in presence of ambient gas and external magnetic field, it have been observe that pronounced structures are developed at edge and also inside the plasma plume due to magneto-hydrodynamic instability. On making a comparison of barium plasma with the results available in the literature for laser produced plasma experiments with various targets, we have observed some new features with some striking differences. The expansion dynamics, composition (ratio of ions and neutrals) and its evolution, time and space variation of plasma parameters (electron temperature and density) and excitation processes is significantly different from the reported results. Detailed analysis of the present observation is going on. Apart from the continuing the above studies, we have developed experimental facilities to identification and quantitative determination of the elements, chemical composition and clusters present in ablated plume using Laser-Induced Breakdown Spectroscopy (LIBS) technique. The Laser-Induced Breakdown Spectroscopy (LIBS) technique is based on spectral analysis of the atomic and ionic emission lines of the sample species generated by the intense laser pulse-sample interaction. The experimental parameters and properties of the sample affect the plasma composition. This effect (Matrix effect) is avoided by the various complicated calibration methods for accurate elemental analysis. In the present approach, we are optimizing the experimental procedure to perform the calibration free LIBS technique for quantitative elemental analysis. Preliminary data have been recorded and their analysis and supporting theoretical modelling are in progress. Further the experiment related to the double pulse technique in which two laser pulses separated by a few tens of nanosecond to few microseconds are used to ablate the target sample, are also performed to increase the sensitivity of LIBS single.

A.3.11 Magnetized Beam Plasma Surface Interaction Experiment

This experiment is looking at different physics aspects pertaining to the phenomena related to dense magnetized plasmas and its interaction with material surfaces. The experiments are primarily motivated from practical application such as plasma wall interaction in a fusion device where the main concern is how one can control high heat flux on plasma facing components. Magnetized plasma surface interaction also finds important application as in negative ion beam source, in plasma thrusters and low temperature plasma processing of materials. Current experiment is looking at the properties of the linear magnetized plasma device (figure A.3.11.1). The plasma source is based on D.C cylindrical magnetron and constricted anode that produces an intense annulus plasma column (figure-A.3.11.2) expanding in vacuum in the presence of strong axial magnetic field (80 m Tesla). The annular plasma shown in is produced by DC discharge due to the synergistic effect of the axial magnetic field and the hollow cylindrical cathode which results in the confinement of secondary electrons emerging from ion bombardment at the cathode surface. The efficiency of the discharge is further improved by maintaining a differential pressure of 100 Pa between the anode and the cathode by placing a grounded electrode having 1.0 mm orifice close to the constricted anode. The plasma properties measured at two axial locations 19.0 cm and 39.0 cm from the source shows double-hump structure in the radial flux profile (figure A.3.11.3). At modest operating powers of 200 - 240 Watts the peak flux measured using a single Langmuir probe biased at -30 V is found in the order of $\sim 10^{22}$ m⁻²sec⁻¹. Both electron temperature and density is found to fall similarly by a factor of 3 or higher at axial distance of 39 cm from the edge of the cathode. The

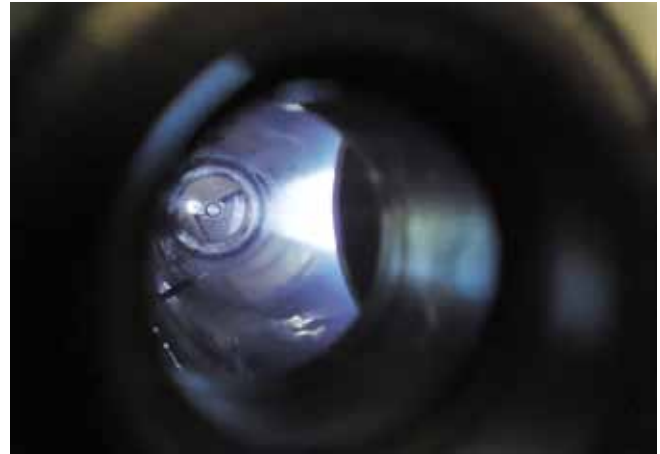

Figure A.3.11.2: Plasma column

reason behind the observance of the annular plasma column is attributed to the property of the source. Our next aim is to upscale the density of the source to operate at 20 kW. In addition new experimental project on the study of pair-ion plasma comprising of positive and negative ion species has been initiated in the 12th five year plan project. Fundamentally the ion-ion plasmas exhibit remarkable different thermodynamic properties than ordinary electron-ion plasmas, as the opposing charged species have nearly same mass and they nearly in thermodynamic equilibrium. The project will involve development and characterization of the ion-ion plasma in the laboratory to the study of time-dependent perturbation introduced in the ion-ion plasma.

--!!!--



Figure A.3.11.1: The Linear Plasma Device

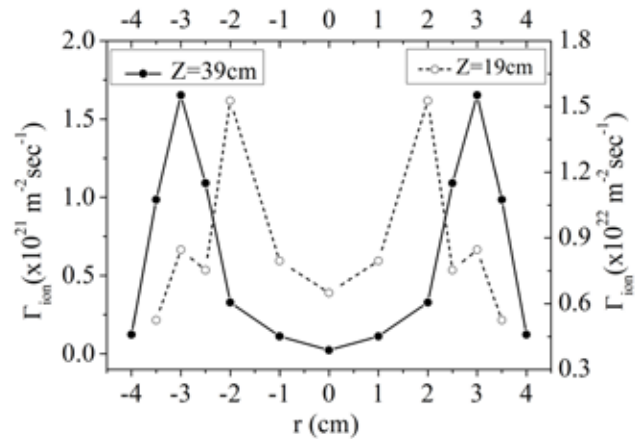

Figure A.3.11.3: Radial flux of the annular plasma column at two axial locations $z= 19.0$ and 30.0 cm from the source.

A.4. Theoretical, modeling and Computational Plasma Physics

A.4.1. Basic Plasma Studies

Breaking of Upper hybrid oscillations in presence of inhomogeneous magnetic field : The spatio-temporal evolution of large amplitude upper hybrid modes in a cold homogeneous plasma in presence of an inhomogeneous magnetic field has been studied. Using the method of Lagrange variables, an exact space-time dependent solution is obtained in parametric form. It is found that the magnetic field inhomogeneity causes various nonlinearly excited modes to couple resulting in phase mixing and eventual breaking of the initially excited mode. Occurrence of wave breaking is seen by the appearance of spikes in the density profile. These results may be of relevance to laboratory / space plasma situations where the external magnetic field is inhomogeneous.

Breaking of longitudinal Akhiezer-Polovin Waves : Breaking criterion of Akhiezer-Polovin (AP) longitudinal waves is routinely used for interpreting the observation of laser/beam plasma wakefield experiments. In this work using 1-D simulation, we show for the first time that AP longitudinal waves break through a novel mechanism called phase mixing at an amplitude well below the amplitude governed by the breaking criterion, when subjected to an arbitrarily small amplitude longitudinal perturbation. Results from the 1-D relativistic code based on Dawson sheet model show a good agreement with the Dawson phase mixing formula modified to include relativistic mass variation effects. This result may be of direct relevance to plasma based particle acceleration schemes.

Bernstein-Greene-Kruskal waves in relativistic cold plasma : Bernstein-Greene-Kruskal waves in a relativistic cold plasma, which are usually known as Akhiezer-Polovin longitudinal waves have been known for more than five decades. The usual derivation of these waves requires a travelling wave ansatz. In this work we provide an alternative derivation, using the method of Lagrange variables and using the requirement that the longitudinal waves so generated do not phase mix. Our work facilitates the excitation of an A-P longitudinal wave in a 1-D PIC or a sheet code.

A.4.2. Laser-Plasma Studies

Nonlinear coherent solutions of the Laser Plasma coupled system : New variety of slow moving flat top nonlinear coherent soliton structures for the coupled set of laser plasma interaction system were obtained. This solution was studied in detail. The formation of these structures (at a particular range of laser frequency and propagation speed) has been understood by reducing the governing plasma fluid and

Maxwell's set of equations to the Ginzburg – Landau form under appropriate approximations. The evolution of these structures show a development of instability which has been identified as the Brillouin scattering instability. The Plasma being cold the role of temperature is taken up by the electron quiver speed in the laser radiation.

Laser cluster interaction with sub-cycle laser pulses : The phenomena of absorption of sub – cycle laser light in nano – sized atomic clusters was studied using Particle – In – Cell (PIC) simulations. It is shown that the linear resonance (LR) and the anharmonic resonance (AHR) can be optimized for efficient energy absorption.

A.4.3. Dusty-Plasma Studies

Observations of singular cusp solutions in dusty plasma medium : High amplitude pulse like structures have been observed in water channels to propagate over long distances without distortion or attenuation. Such structures known as “Solitons” have also been observed in the ocean, in charged fluid systems like a plasma and even in semiconductor media. Another well-known wave phenomenon is that of wave breaking - a familiar sight on the beach front when a growing water wave finally topples over as it hits the shore. Our present studies show the existence of novel nonlinear structures that combine the above two physical features in the context of dust impregnated plasmas. They consist of solitonic structures that have an amplitude close to the wave breaking limit that however do not topple over but dithering at this amplitude continue un-attenuated propagation over long distances. These stable high amplitude coherent singular structures that do not immediately break, provide a novel possibility of storing coherent energy in a medium. The coherent field of the maximal amplitude structures can also be manipulated for various applications, such as particle acceleration, transport of energy inside fusion targets etc.

2-D Kelvin Helmholtz (KH) studies in a dusty plasma : The high charge density and low temperature of dust species makes them strongly correlated in a dust impregnated plasma. Such a system, therefore, often behaves like a visco – elastic fluid. The behavior of the fluid Kelvin – Helmholtz (KH) instability in the dusty plasma medium has been studied in both weak and strong coupling regimes. The role of compressible and shear modes on the instability is identified. The nonlinear simulations show the recurrence of KH instability in the strong coupling regime.

A.4.4. Global Gyrokinetic Studies

Role of Background ExB shear in linear and nonlinear ITG modes in the generation of flows in Tokamaks: A study using GENE code under Indo-SWISS collaborations : Un-

derstanding Momentum transport or flow generation studies in Tokamaks have become important as it is understood that shear flows tend to control turbulence levels. Using GENE code, two important studies have been carried out 1. The role of Background or Equilibrium ExB shear on flows using flux tube code GENE 2. The origin of flows due to nonlinear processes in ITG turbulence using GENE. While it appears that symmetry breaking mechanisms can be shown to be the cause for the 1st case, in the latter, the process of flow generation is more intricately connected to nonlinearity and turbulence.

Fast particle passive transport studies under PPPL-IPR collaborations using GTS code : Hot ion transport has been studied using a global gyrokinetic nonlinear simulation in the presence of ion temperature gradient (ITG) driven turbulence. The measured transport tends to saturate as the system size increases exhibiting a continuous transition from a subdiffusive process toward diffusive one. At stronger ITG drive characterized by the temperature gradient of thermal ions hot ions with lower energy remain virtually unaffected, whereas transport of hot ions with higher energy continue to increase with the gradient. The nature of transport of hot ions is studied in the presence of microturbulence generated by the trapped electron mode in a tokamak using massively parallel, first principle based global nonlinear gyrokinetic simulation, and with the help of a passive tracer method. Passing and trapped hot ions are observed to exhibit inverse and inverse square scaling with energy, while those with isotropic pitch distribution are found to exhibit inverse dependence on energy. For all types of hot ions, namely, isotropic, passing and trapped, the radial transport appears to be subdiffusive for the parameters considered.

A.4.5 Molecular Dynamics Simulation

Kolmogorov Flows in Strongly Coupled Plasmas: "A Molecular Dynamics Study" : Kolmogorov flows have been widely used to study flow instability and transition to turbulence in Navier-Stokes fluids. In the two dimensional case, Kolmogorov flow is generated by imposing a unidirectional force with magnitude varying sinusoidally along the other direction. For small enough forcing magnitude, this results into a series of parallel shear bands having sinusoidal velocity profile. At higher forcing magnitudes, the destabilizing inertial effects dominate over the stabilizing viscous effects and the velocity profile undergoes a transition to a vortex lattice and eventually turbulence. We have studied through large scale molecular dynamics simulations, the fate of such Kolmogorov flows in a strongly coupled Yukawa liquid. Such Yukawa liquids are ubiquitous in nature and typical examples include complex "dusty" plasma, colloids and certain dense astrophysical systems. They can exist in a state of strong coupling wherein the ratio of average potential to kinetic energy

can significantly exceed unity. Starting from a thermally equilibrated Yukawa liquid, we superpose a sinusoidal velocity profile and observe a freely decaying Kolmogorov flow. The global transition of the flow pattern upon changing flow parameters is elucidated through various diagnostics.

A Molecular Dynamics Study of Dipolar Vortices in Strongly Coupled Yukawa Liquids : Coherent dipolar vortices are a universal outcome of injecting linear momentum into a liquid. Once formed, these dipolar vortices can transport mass and momentum over large length scales and are hence a subject matter of intense research work. Using "first principles" classical molecular dynamics simulations, we report for the first time, formation and collision of dipolar vortices in a two-dimensional prototype strongly coupled liquid, namely the Yukawa liquid. A dipolar vortex is seen to emerge from the self-organization of a sub-sonic jet profile. This dipole is seen to be very robust and, in general, shows a nonlinear relationship between vorticity and stream function. Starting from two jets injecting linear momentum in mutually opposite directions, we report on the centered head-on collisions between two dipolar vortices. Effect of background friction on the dipole evolution is investigated.

Is glass-like transition a possibility in strongly coupled Yukawa systems - MD study : During the period, we spent some of our time in literature survey to understand the technique of supercooling and glass-formation phenomena. Then we have started to implement the molecular dynamics (MD) simulation of the cooling of Yukawa dusty plasma system at constant temperature using velocity Verlet method. On cooling, the liquid has a great tendency to crystallize, but if cooled quickly enough it undergoes a transition that can be regarded as a glass transition and that occurs at higher temperature than the corresponding transition in the laboratory. However, a comprehensive understanding of the glassy state is still lacking. We are mainly interested to study the glass transition in Yukawa dusty plasma system by calculating pair-correlation function, the self diffusion coefficient, velocity autocorrelation function, the coefficient of shear viscosity, heat flux autocorrelation function, both longitudinal and transverse current correlation function and dynamics structure factor. To understand all the above mentioned diagnostic techniques we have started to spend some time in literature survey and also started to implement them one by one. Till now pair-correlation function, the self diffusion coefficient, velocity autocorrelation function, the coefficient of shear viscosity and heat flux autocorrelation function have been implemented.

A.4.6. Modelling and Demo Studies

Integrated Tokamak Modeling : The Indian predictive integrated tokamak modeling (ITM) activity has been initiated. In this, the core plasma transport is being coupled with vari-

ous physics modules to explain the experimental observation. For this activity, all these numerical models have to be made available in the same computational platform. Three high-end workstations have been procured with relevant softwares and installed recently. The plasma core transport module has been installed successfully in this machine. The other relevant physics modules are being installed. These modules will be coupled with proper interfaces. This ITM tool will be needed to predict the plasma scenario for tokamak devices like SST-1, ITER and future reactor devices. This group is also collaborating with General Atomics, San Diego, USA in developing IMFIT. IMFIT is another integrated modeling tool which has the capability to reconstruct the plasma from experimentally measured data. This is very much needed for SST-1 which will be operational soon. For this purpose, we purchased computers and necessary software installations are on-going.

Non-axisymmetric MHD equilibrium : The tokamak plasma equilibrium is generally considered as axisymmetric and 2D MHD equilibrium is good enough to explain the experimental observations. But, in the recent past, various coils placed toroidally have improved the confinement and stability of tokamak plasma. This necessitated constructing plasma using 3D MHD equilibrium. This activity has been taken up in collaboration with General Atomics and is progressing well. The variational moments method for a given plasma pressure and current profile has been developed analytically. This formulation is being implemented numerically and the validation of this method using Solovév equilibrium has to be carried out.

Modeling activities related to ADITYA and SST-1 : The recent observation of direct electron heating due to ion-cyclotron resonance heating (ICRH) in ADITYA has been modeled with TORIC code and qualitatively predicted the experimental observations. This work is being extended to predict the temperature increase through a transport simulation. An interface is being developed to include the ICRH physics in the transport simulation to predict the observed temperature rise in these experiments. In SST-1, recently the 16 TF coils are assembled and the deviations in their positions have been experimentally measured. The design requirement on TF coils for plasma performance is such that the ripple in toroidal magnetic field should be less than 1 % within the plasma region and the error field (radial and vertical components) in the plasma region should be minimized. This calculation has been re-visited with these measured deviations and found that the ripple requirement is well within the designed one. However, the error field has a strong $n=4$ components and this has to be compensated through correction coils. If the error components up to $n=4$ are compensated, then the remaining error field from higher components are found to be less than 20 G. Figure A.4.6.1 shows the total error field (red color) and the residue after compensation up to $n = 4$ (blue

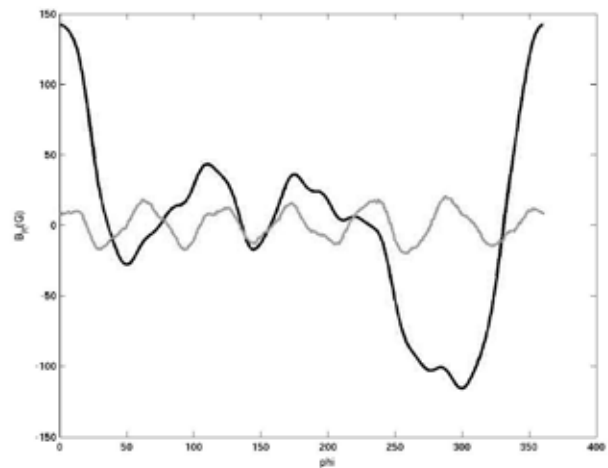

Figure A.4.6.1 The total error field and residual field after compensation

color). This is in acceptable design limit. For this one set of C-coils either inside the vessel or outside the cryostat is desirable. This depends on the available space and this work is in progress.

Scrape-off layer study : Two-dimensional (2D) interchange turbulence in a scrape-off layer of tokamak plasmas and their subsequent contribution to anomalous plasma transport has got much of current interest. We have demonstrated that the inclusion of ion energy equation (using simulation) changes nature of plasma turbulence. Finite ion temperature reduces floating potential about 15% compared to the cold ion temperature approximation and also reduces radial electric field. Rotation of plasma blob at an angular velocity about 1.5×10^5 rad/seconds has been observed. It is found that blob rotation keeps plasma blob charge separation at an angular position with respect to the vertical direction that gives a generation of radial electric field. Plasma blobs with high electron temperature gradients can align the charge separation almost in the radial direction. Influence of high ion temperature and its gradient has been presented. Presently, we are investigating the turbulence using 3D code in the edge and SOL regions. An OpenMP parallel code is being developed for this purpose.

DEMO design activity : The design of fusion reactor needs physics, engineering and neutronic analysis to be carried out together. A design tool has to be developed and validated with available reactor designs or with experimental D-T shots. The physics design based on power balance, ignition criterion, and energy confinement scaling has been developed and this predicted the radial build-up of a typical fusion reactor. This has been extended to include the engineering and neutronic analysis. This preliminary design tool is being developed.

B. ACTIVITIES ON OTHER CAMPUSES.

B.1 Facilitation Center for Industrial Plasma Technologies (FCIPT) Activities

FCIPT (<http://www.plasmaindia.com>) is a division of IPR, and has a mandate to develop plasma based technologies on commercial basis. Further, it also acts as a link between the Institute for Plasma Research (IPR) and Indian industry. At FCIPT, the following activities were undertaken.

B.1.1 Fundamental Plasma Activities In Industrial Plasma Applications

Design and Development of Basic Plasma Experimental Systems for Delhi University, New Delhi : This is in continuation of the activity, that was taken up in the last year where in FCIPT has received an order from Delhi University (DU) for the design and development of four basic plasma experimental systems. One of the four systems, Pulsed Plasma Nitriding system, was installed and commissioned at DU in the last year. In the current year, the installation and commissioning of two more systems viz. 1) ExB Cylindrical Drift Velocity measurement system (CDPS) and 2) Washer-gun based Pulsed Plasma System (WGPS); is successfully carried out. Photograph of the CDPS system is shown in the figure B.1.1.1.

Plasma Torch Development : Based on the operational ex-

perience gained on low power plasma torch, new improved plasma torch was set up with all kinds of stabilization mechanisms incorporated into it. Complete torch system with sub-systems such as cooling & gas supply, power supply, voltage, current & temperature sensors, data acquisition system with temperature logger, and computer has been installed. Torch operation and data transfer to computer via acquisition system can be controlled using programs which have been built on LabVIEW platform. Exhaustive studies were carried out to explore role of controllable experimental parameters such as arc current, axial (plasma forming) gas flow, shroud (stabilizing) gas flow and magnetic field on the torch efficiency and operation. Interesting results have emerged which indicate complex dependence of shroud gas and magnetic field on the electro-thermal efficiency of the torch. Unique dimensionless numbers for this plasma torch configuration have also been worked out and experimentation is underway for generating data in the remaining operational regime. This will enable to build functional relationship between arc voltage & efficiency and controllable experimental parameters for scale-up to higher powers. A first-cut enthalpy probe for point-to-point measurement of plasma enthalpy and temperature has also been designed, fabricated and presently being integrated with the torch system. This diagnostic is being specifically used for generating information on temperature & enthalpy for validating results obtained from numerical simulation work carried out by a university as part of BRFST funded project and will compliment the experimental studies.



Figure B.1.1.1: Photographs of the CDPS system installed at Delhi University



Figure B.1.1.2 : Photograph of the torch in operation along with enthalpy probe



Figure B.1.1.3 : Photographs of (a) circular and (b) rectangular magnetron cathodes (targets)

Magnetron Cathode Development at FCIPT : Magnetron is a device which is used to deposit metals and insulators by sputtering of the material. Sputtering of the material is done by high energetic ions of gas used to create plasma which is confined near the material (which is the cathode and is also called as target) using specific magnetic field generated by appropriate magnets. Since many of the research activities at FCIPT are based on plasma based PVD techniques, an activity to develop an indigenous magnetron has been taken up at FCIPT. It was taken up to develop both circular and rectangular planar magnetrons. In the case of circular magnetron, a 3inch magnetron was designed and developed at FCIPT. But for depositing on larger areas, the rectangular magnetron is more useful and hence a rectangular magnetron is also developed. The typical size of the rectangular magnetron cathode is 55mm x 265mm. Rare earth permanent magnets are used for obtaining the required magnetic field. Both these magnetrons have been tested and used successfully for depositing metallic coatings. However, there is a lot of scope for improvement, particularly in the case of rectangular magnetron, and the efforts are on to improve the devices. The figure B.1.1.3 shows the photographs of the magnetron cathodes where in the race tracks are clearly visible.

Development of Molybdenum thin film using Magnetron Sputtering : Molybdenum (Mo) thin films are used as back contact layer in the compound thin film solar cells of chalcopyrite family. This layer should be electrically conducting to work as a back contact for a solar cell and the adhesion of the film should be good. DC magnetron sputtering technique is being used, at FCIPT, to develop the Mo thin film on glass. Typical film thickness that is required is of the order of 500 nm. The discharge power and the operating pressure have been varied to optimize the film properties by keeping the discharge current constant. Deposited thin films were characterized using XRD and SEM for structural properties, tape-test for adhesion properties and four-probe method for measuring electrical resistivity. The process has been optimized to deposit Mo thin films with low resistivity ($3 \times 10^{-5} \Omega\text{-cm}$) and better adhesion. It was also tried out to deposit Mo as a bi-layer or multi-layer film (each layer deposited at various operating pressure) to develop an overall film with low resistivity and best adhesion properties.

B.1.2 Plasma Surface Engineering

Development of Industrial Scale Atmospheric Pressure Air Plasma System to Treat Angora Wool : This project was sanctioned by DST to develop and demonstrate industrial scale atmospheric pressure air plasma treatment system to modify

the surface properties of 1 m wide Angora web to improve processing of Angora wool. FCIPT, IPR has transferred the know-how of this technology to M/s InspirOn Engineering private limited, Ahmedabad. The full scale industrial plasma system for processing Angora wool has been developed by M/S Inspiron Engg Pvt. Ltd., under technology license from FCIPT-IPR and NID. This industrial scale system can run at speeds of 4.5 m/min or higher and uses air and electricity. This system will be installed at HIFEED, Ranichauri, Uttarakhand. This state of the art industrial scale system is the first one in the world for Angora wool processing using plasmas. The photograph of the full scale industrial plasma system is shown in the figure 2 of cover page 3.

Hot-Dip Aluminized Coatings : The development of hot dip aluminized coatings have been undertaken by FCIPT in collaboration with TBM division of IPR. The optimization of the case with a top Al_2O_3 layer followed by a diffused FeAl coating has been done. An Al_2O_3 coating of ~3-4 micron thick followed by an FeAl/Fe(Al) coating of 65 micron thick has been deposited on 9Cr-1Mo steels. The core hardness has been stabilized at 298 HV0.25. At present, the coated specimen are subjected to validation test for their compatibility with Pb-17Li.

Effect of plasma nitriding on duplex coated AISI M2 steel : In this study, AISI M2 High Speed Steel was selected as the substrate material because they are mostly used as cutting tool materials. An attempt has been made to first plasma nitride at 500° C for 24 hours with 80% nitrogen and 20% hydrogen gas mixture ratio prior to TiN coating. Plasma nitriding was then carried out on the duplex coated steel substrates. More emphasis was made to form TiN phase on AISI M2 steel by varying nitrogen gas flow rates during TiN coating. Variations of the microhardness, surface morphology, and structural phase changes have been investigated using a surface roughness tester, Vickers microhardness tester, scanning electron microscopy (SEM) and X-ray diffraction (XRD). It was found that TiN layers deposited using higher flow rates of nitrogen resulted in thin film thickness due to low deposition rates. The higher coating thickness having rougher surface results in an increase in coating hardness. After plasma nitriding the TiN coated AISI M2 steel substrates, the crystallite size decreases due to nitrogen ion bombardment. The reason for reducing crystallite size can be attributed to defects generated on the surface resulting in increasing number of preferential nucleation sites. With increase in nitrogen flow rate the crystallite size decreases due to nitrogen ion bombardment on thin TiN layers and hence surface hardness increases. For duplex coated steel, the shifts of iron nitride peaks are low

due to increase in intensity of iron nitrides and the intensity of TiN peak decreases. Also, after plasma nitriding there is a preferential orientation of (111) and (200) planes of TiN after plasma nitriding on duplex coating owing due to the presence of plasma nitrided layer as shown in figure B.1.2.2.

Erbium Oxide Coating Development and Characterization : Er₂O₃ coating development experiments initiated in the previous year with an aim to develop and validate tritium permeation barrier and electrically insulative coating for the TBM application to mitigate tritium loss and MHD drag problems, were further extended to achieve the most stable cubic crystalline structure of the reactive magnetron sputter deposited films. The oxide films deposited at different parameters were annealed in a vacuum chamber observed using X-ray diffraction (XRD) that the cubic crystallinity was somewhat improved. For further improvement, a modification of the coating system was designed to make it compatible to substrate heating at 700° C during the coating process. Accordingly the modification work was carried out and the system was tested for high vacuum and substrate heating at 520° C, limited by the capacity of the available substrate heater. It would be tested at even higher temperature with special heaters to be mounted in it.

Surface Phase Transformation in SS304 due to Surface Preparation Techniques : Various SS304 surfaces prepared by grinding, machining, polishing and electro-polishing were characterized using powder and grazing incidence XRD for studying the stress-induced martensite formation as a function of above processes. In order to sustain harsh conditions of wear, tear and corrosion in various applications of stainless steel, diffusion hardening techniques are employed to alter its surface properties. Hence the diffusion of the species into top surface is considered a basic aspect determining the success

of it and the diffusion must depend on the phase composition and microstructure of the surface. Hence we investigate and study the surface phase transformations in SS304 due to various surface preparation techniques through present experiments. Samples were prepared with different polishing treatments and electro polishing and combination of electro polishing and mirror polishing. They were then analyzed for their surface roughness, the phases contained and microstructure. It was observed from the relative powder XRD characteristic patterns that the amount of martensite formed in mechanically polished samples is more than in electro polished samples. This can be asserted due to the stress-induced transformation during the mechanical polishing. Further it was observed that a trace amount of martensite is present in all electro polished samples irrespective of duration of electropolishing.

Development and Characterization of Tungsten Coating on Graphite : The purity of the plasma in a Tokamak is of utmost importance due to the energy loss caused by the radiation from the impurities. Hence ideal plasma facing component (PFC) should release minimum material to the hot plasma during its interaction with energetic charged particles coming from plasma. Relatively very low sputtering yield of tungsten, as compared to most of other thermally and electrically conductive materials, make tungsten as one of the favorable candidates for this application as PFC. As a first leap towards studying the behavior of tungsten film as plasma facing material of Aditya Tokamak, we in collaboration of Aditya Vacuum group have carried out magnetron sputter deposition of tungsten on graphite substrate. We have attempted to optimize the deposition process for typically 1 micron thick, stable films on glass substrate and characterized them using X-ray diffraction and Scanning electron microscopy (SEM) for its crystal and micro structures. Subsequently, deposition was carried out on graphite on and near optimized parameters. Figure B.1.2.3 shows the variation in the surface and cross-section morphology as a function of deposition pressure captured by SEM.

Preparation and Characterization of SnO₂:Sb Thin films by Co-Evaporation of Sn and Sb by Plasma Assisted Thermal Evaporation : Tin oxide (SnO₂) thin films with promising properties, makes itself very important transparent conductor in various applications such as solar cells, flat panel displays and optoelectronic devices. Doping with pentavalent impurity such as Antimony (Sb), Fluorine (F) and Molybdenum (Mo) enhance its conductivity considerably. In order to study the effect of Sb doping, SnO₂ : Sb thin films have been prepared by the co-evaporation of Sn and Sb using Plasma

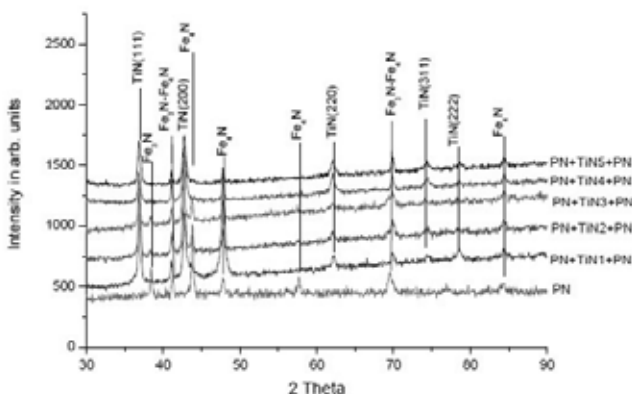

Figure B.1.2.2 : XRD pattern of Plasma Nitrided Duplex coated AISI M2 Steel

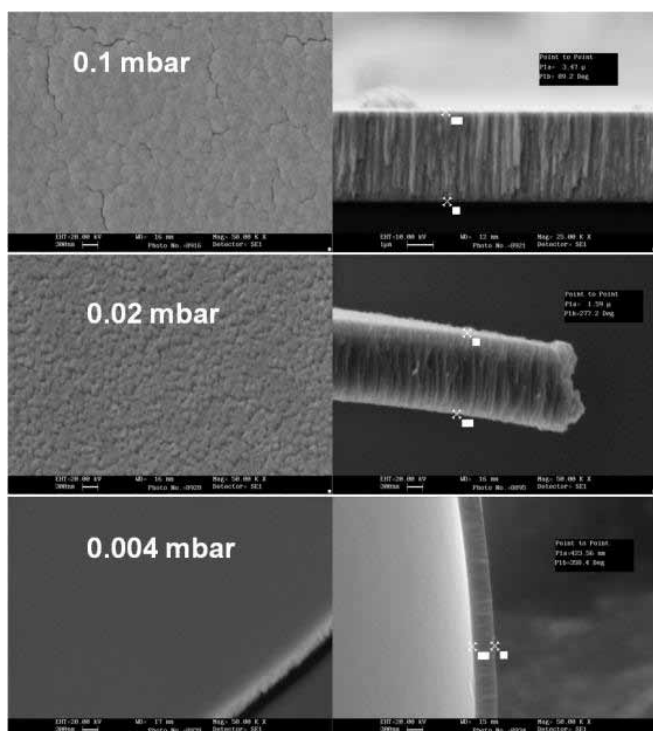

Figure B.1.2.3: SEM images showing morphological variation of the W films with changing deposition pressure

Assisted Thermal Evaporation (PATE) in oxygen (O₂) partial pressure at various doping levels from 4 at% to 25 at%. The influence of various Sb doping levels on the compositional, electrical, optical and structural properties have been investigated using various techniques, which have identified the role of Sb content in the film. The best electrical resistivity of 0.5 ohm-cm is obtained for SnO₂ : Sb with 4% Sb content in the films in comparison to optimized SnO₂ film (7 ohm-cm), confirm the usefulness of SnO₂ : Sb (4 at %) films for device applications.

B.1.3 Plasma Pyrolysis

Disposal and Gasification of Petroleum Waste using Plasma Pyrolysis / Gasification : Storage and safe disposal of petroleum sludge and other remains of refineries is a serious concern world over. Plasma the most active state of matter can provide unique cost effective solution to this problem. In order to explore this possibility, Bharat Petroleum Corporation Limited (BPCL) has sponsored a project to FCIPT, IPR, on “Plasma Gasification of Petroleum FEED”. At FCIPT, we have successfully developed and demonstrated the plasma gasification of petroleum FEED (vacuum residue, tank sludge and pet-coke) and production of syn gas along with higher

hydrocarbons. Designing of appropriate feeding mechanism for individual petroleum FEED having different physical and chemical properties was a critical learning phase. The plasma gasification of the petroleum waste was carried out (i) at different oxygen flow rates (ii) at different steam flow rates and (iii) keeping the steam flow fix (optimised value obtained from previous experiments) and only varying oxygen flow rate. All the experiments were carried out at constant power. In addition, the quantity of the individual feed was also kept constant during the experiments. The results revealed that vacuum residue provides higher quantity of syn gas in comparison to tank sludge and the pet-coke. For various FEED materials the percentage of Syn gas formed are mentioned in the table B.1.3.1. The project has been completed successfully and demonstrated to the BPCL team.

FEED	Parameters	With Oxygen	With Steam	With Mixture of both
Vacuum Residue	Syn Gas % (H ₂ + CO)	85.4 %	67.63%	73.8%
Tank Sludge	Syn Gas % (H ₂ + CO)	70.5 %	71.8 %	66.4%
Pet-Coke	Syn Gas % (H ₂ + CO)	68.5 %	70.81 %	77.5 %

Table B.1.3.1: Percentage of Syn gas formed for various FEED at fixed plasma power

Collaborative Project with Pandit. Deendayal Petroleum University : A collaborative project sponsored by Department of Science & Technology, New Delhi on “Studies on Thermal Plasma Pyrolysis of Crude Oil Residue and Energy Recovery” is being carried out at FCIPT since last year. In this project, we are using the existing plasma pyrolysis system at FCIPT, with a modified feeder. Initially, temperature profile in the primary chamber has been theoretically calculated – without gas flow mechanism – in graphite torch based plasma system which is also experimentally determined at the later stage. The crude oil residue (vacuum residue, tank sludge and pet coke) was obtained from M/s Reliance Industries Ltd. Jamnagar. The gases formed after the plasma pyrolysis of petroleum feed were identified at different temperature. Reforming of hydrocarbon gases obtained from crude oil residue pyrolysis will be done using catalysts (ZSM-5, Ni/Al₂O₃ etc.) which will work at moderate temperature and pressure and will modify the higher C molecules into smaller fragments. For this purpose designing and fabrication of catalyst bed is in progress.



Analysis of Gases when Crude Oil residue is Pyrolysed **	
Temperature °C	900
CO %	4.89
H ₂ %	32.89
Methane %	14.08
Ethylene %	0.9
Ethane %	4.03
Iso Butane %	0.02
n Butane %	0.01
Propane %	0.08
Nitrogen & Other Hydrocarbons %	42 - 43%

** Sample analysis was carried out by SGS India Pvt Ltd.

Development of IGBT based Torch : The Plasma Pyrolysis system of 12-15 kg/hr capacity at FCIPT requires 25kW Plasma torch to increase and maintain the temperature of primary chamber at 650 – 800° C. The plasma torch basically has drooping characteristics and the operating point on this is governed by the source impedance. Therefore a high impedance source is required for this plasma torch. The impedance can be controlled both by electrical and electronic means. The electrical method incorporates the high impedance transformer, which is an inefficient method in terms of power efficiency. The electronic method incorporates the SMPS based topology which is highly efficient and therefore, now a days, is applied in almost all instruments. The experiments were carried out at FCIPT with this electronics topology to run the graphite electrode based plasma torch at 25 kW power and observed that the plasma arc is more stabilized with this method in particular operating conditions. We further designed a higher power system of 50 kW rating to increase the capacity of the Plasma Pyrolysis System. This high power system is under fabrication.

Design and Development of Microwave Torch of 600 W : In most of the applications the plasma torch comprises of electrodes made of copper or graphite. The microwave plasma torch is an electrode less plasma torch which has many advantages over plasma torch with electrodes. A small microwave torch was developed at FCIPT using a commercial microwave oven, waveguide WR284, directional coupler, tapered waveguide (transformer), quartz tube, sparker mechanism etc. Sparker mechanism is needed because the microwave power can not initiate the ionization at atmospheric pressure. The torch was successfully run at 600 W power and based on the results obtained with this torch, it is being worked out to development of a high power (3 kW) microwave torch at FCIPT.

Installation of Plasma Pyrolysis System at SCTISMT, Trivandrum, Kerala : A Plasma Pyrolysis System has been installed and commissioned at Shree Chitra Tirunal Institute for Medical Science and Technology (SCTIMST), Trivandrum, in February 2012. The project was funded by Department of Science & Technology, New Delhi, and the system was fabricated by M/s Bhagwati Pyrotech Pvt. Ltd. to whom IPR has transferred the technology. This system is meant for disposing bio-medical waste and has a waste disposal capacity of 20 kg/hour. The photograph of the installed system is shown in the figure B.1.3.1.

B.1.4. Research, Development and Other Activities

Design and development of Bipolar pulsed power supply for Jadavpur University, Calcutta : In a fusion reactor dust can be formed due to ion bombardment process. Dust formation is a serious issue because it can lead to a discharge disruption. Using an appropriate electric field configuration dust can be removed from the plasma environment. To generate such an electric field a bipolar pulsed power supply of 50 KHz frequency has been designed and developed at FCIPT. This Bipolar pulsed power supply can deliver 800 Volts, 1 Amp current at 25 % duty cycle (in both polarities). These dusty plasma experiments will be performed at Jadavpur University, Calcutta.

Spacecraft Plasma Interaction eXperiments (SPIX-II) : For the detection of arcing over the satellite solar arrays surfaces, an experimental test facility for the Lower Earth Orbit (LEO) and Geo Synchronous Orbit (GEO) like environment is under development. This facility comprises of a linear X-Z stage, non contact surface potential measuring device, NIR camera, and a Labview based Data acquisition (DAQ) system. To integrate and communicate among various devices, sub systems and also diagnostic instruments, a high speed DAQ system is being developed. This DAQ system can acquire and process the various types of arc images under LEO and GEO space plasma environments. This complete DAQ system is configured on Labview platform with National Instruments hardware which includes high speed data acquisition of various voltage and current signals, image acquisition from camera, synchronization of the acquired data with image acquisition, control of X-Z motorised stage etc. Using a non contact electrostatic probe, surface potential distributed over the surface of a printed circuit board has been measured and from this captured data an intensity chart has been plotted (shown in figure B.1.4.1).



Figure B.1.3.1 : Plasma Pyrolysis System installed at SC-TIMST, Trivandrum

B.1.5. Surface Characterization Lab Activities

The surface characterization lab is engaged in characterizing various materials to aid the internal research & developmental activities and also to the external customers on commercial basis.

Internal Research and Development and Project work: The necessary characterization work associated with the internal activities, both from IPR and FCIPT, is regularly carried out. Some of the important activities with important role of characterization are given below.

- 1) 4A type zeolite, activated Alumina and Carbon molecular sieve samples were measured with powder XRD and analyzed for identifying their phase content and purity, as these materials are being explored by TBM division, IPR for application into tritium extraction system.
- 2) Sb doped SnO₂ films prepared by plasma assisted thermal evaporation method were characterized using powder and grazing incidence XRD and crystalline SnO₂ phase was identified for specific deposition parameters.
- 3) In a Surface morphological study after modification of woven poly propylene fabric by dielectric barrier discharge, it has been observed that the dye up take properties of the fabric has been improved, which may be due to introduction of polar groups and increase in surface roughness.
- 4) Thin film deposition of Mo (bottom layer), ZnO and Al doped ZnO (Transparent conducting oxide) on silicon and glass were carried out by magnetron sputtering for solar cell



Figure B.1.4.1 : By using a non-contact electrostatic probe, intensity charge displaying the potential distribution over the surface of printed circuit board depicting the satellite solar array dimension

applications. The films are examined under SEM and XRD for the surface morphology, thicknesses and phase identification.

- 5) Functionally graded material (FGM) W-Cu alloy prepared from P/ M route) for plasma facing components of Divertor has been analyzed with SEM and EDX for its gradation, concentration of the elements and porosity density.
- 6) The effect of alloying element (Si) in Al melt on the morphology and microstructure of coating by Hot Dip Aluminizing (HDA) experiments of 9Cr steels has been examined with SEM and chemical composition has been carried out by EDX qualitatively and quantitatively.
- 7) Combinational effects of Plasma nitriding and TiN sputter coating multilayer on SS in varying order of process were investigated using powder XRD.
- 8) SS 410, 17-4PH, 304 and A-286 surfaces are characterized using grazing incidence XRD prior to treatment and post treatments of short duration Plasma Nitriding and Plasma Nitrocarburising, each at various process temperatures in the range of 350° C to 500° C.

Activities Carried out on Commercial Basis

X-ray Diffraction (XRD), Scanning Electron Microscopy (SEM) and Optical microscopy were offered to external parties on commercial basis. A variety of samples, such as drug powders, clay, new compounds and coatings for academic research etc. were characterized. The customers are from various industries, research institutes and universities.



B.2. ITER-India

B.2.1 Background information on ITER

International Thermo-nuclear Experimental Reactor (ITER) is the world's largest experimental fusion facility, designed to demonstrate the scientific and technological feasibility of nuclear fusion power. ITER is also a first-of-a-kind global collaboration. Nuclear fusion is the process, which powers the sun and the stars. Fusion research is aimed at developing a safe, limitless and environmentally responsible energy source. ITER is being constructed at Cadarache, in the South of France. India is a full Partner in the ITER Project and will contribute about 9% of the ITER construction cost mainly through In-kind contributions like other five of the six Partners (China, India, Japan, the Republic of Korea, the Russian Federation and the USA), while Europe, being the host will contribute about 45%. India will contribute to ITER the Cryostat, the biggest refrigerator vessel ever built in the world, the neutron shielding blocks of the main vacuum vessel, part of the water cooling and heat rejection systems, cryolines and cryo distribution systems, diagnostic neutral beam (DNB) system, all the Ion Cyclotron and part of electron cyclotron heating sources, power supplies and some of the diagnostic systems. ITER is scheduled to start operations in 2020. ITER-India is the Indian Domestic Agency responsible for India's contributions to ITER.

B.2.2 Progress in the ITER Project

In the report period, overall there was good and steady progress made on the ITER construction. Although there was potential risks of schedule delays following the Japanese earthquake in early 2011 resulting in damage of ITER R&D and Industrial facilities in Japan, the IO and the DAs worked hard together to evolve a strategic plan to improve schedule performance including mitigation of potential delays. A Special Task Group (STG) was formed for this purpose, chaired by the Director-General of the ITER International Organisation (IO) and comprising of both technical and policy-level representatives of the Members. They evolved an effective strategy to mitigate the resulting delays in procurement of ITER components, specifically the toroidal field magnets and conductors for the central solenoid from Japan. Significant progress was made in the ITER site construction. Figure B.2.2.1 shows the status of the headquarters building in March 2012, which will be occupied from October 2012. The tokamak building foundation has also been laid and the anti-seismic pads have been installed (Figure B.2.2.2a). The entire tokamak building will be on anti-seismic pads whose safety specifications have been tightened by the French Nuclear Authorities following the Japanese earthquake and

Fukushima disaster. The PF coil winding building has been completed and cranes have been installed (Figure B.2.2.2b). Due to mainly the effects of Fukushima and some other technical problems, the ITER Schedule Performance Index (SPI) remained relatively low between 60-70% during this period and the members are working hard on a schedule recovery strategy to increase the SPI, which should be visible in the coming 1-2 years. This strategy was endorsed by the ITER Council in its November 2011 meeting. Overall ITER has signed till the end of this period 64 Procurement Arrangements (PAs) have, which represent overall about 75% of the total procurement value of the ITER construction. It also developed a robust cost containment strategy to stay within the capped budget of 4700kIUA to complete the construction activities and move into the Operation Phase. During this period the management audit of the ITER Organisation was also carried out and the office of the Comptroller and Auditor General of India was selected as the management assessor (MA). The MA completed the management audit of ITER and submitted their report to ITER Council in its November 2011 (IC-9) meeting with recommendations for a series of steps for improving the efficiency of the ITER IO which are being implemented now. ITER-India also made good progress in the ITER project during this time. During this period, ITER-India signed with ITER IO two major procurement arrangements (PAs), one for the later delivery cryolines and the other for the Cryostat. The Cryostat is our biggest procurement package, which was signed in September 2011. The cryostat will be the largest refrigerating vacuum vessel ever produced in the world, with a diameter of about 29m and a similar height. ITER-India had already shortlisted two potential manufacturers for the cryostat through competitive tendering process and at the time of going to the press, the industry contract for manufacturing the cryostat is about to be signed. ITER-India has also signed the industry contracts for the procurement and delivery of the cryolines. The table B.2.2.1 shows the overall status of the PA signature. We have signed so far (including those signed in April 2012) a total of 13 PAs totaling about 243 kIUA which constitutes about 93% of our overall credit value in ITER contributions. R&D and prototype activities are ongoing in most of these packages, while for the IWS package manufacture is about to start at Avasarala Technologies Ltd. During this period, ITER-India also implemented the SAP Enterprise Resource Planning software system with an aim to modernize administration, finance and management processes and increase efficiency to meet ITER procurement and construction objectives. ITER-India and IPR in general will go live on SAP R3 system (FICO, HCM and MM modules) on April 01 2012. IPR and ITER-India will be the first of DAE organisations to implement SAP ERP system.



Figure B.2.2.1 : ITER headquarters building



Figure B.2.2.2 The tokamak building foundation

B.2.3 In-Wall Shielding (IWS) – ITER WBS 1.5

In Wall Shielding blocks (IWS) shall be placed between outer and inner shells of Vacuum Vessel (VV) to stop escaping the neutrons and to reduce the toroidal magnetic field ripple. These shield structures are made of SS 304B4, SS 304B7, SS 430 and SS 316L (N)-IG and Fasteners (Bolts, Nuts, Spacers, Washers etc.) are made from XM-19 and Inconel-625. The contract for the manufacture of the IWS blocks were placed in 2010 to Avasarala Technologies Ltd (ATL), while the material for the IWS will be supplied by M/s Industeel, France and Carpenter Technologies Corporation. Activities carried out by IWS group are the following :

Corrosion Testing of SS 304 B7: VV-IWS group has carried out general and crevice corrosion study of SS 304B7 produced by Powder Metallurgy Route (PMR) by immersion

method. The test report is under review at ITER-India and will be submitted to IO for review. Test samples were evaluated for Crevice Corrosion after test. Corrosion properties seem adequate to satisfy ITER vacuum vessel operational conditions.

Outgassing rate measurement of VV-IWS materials : IWS group has prepared a procedure to measure thermal outgas-



Figure B.2.2.3 Poloidal Field coil winding building

#	PA	Original credit	PCR credit	Total	PA Date/ Expected PA Date
1	Vessel In-Wall Shields	37.3	0	37.30	24-Sep-09
2	Cryostat (CRST)	68	1.82	69.82	06-Sep-11
3	VVPSS	9	0.00	9.00	01-Oct-2013
4	CWHR	42	8.16	50.16	22-Mar-10
5	TCLL	3.52	0.08	3.60	10-Jun-10
6	Laser Delivery Cryoline (LDCL)	14.08	0.00	14.08	30-Jan-12
7	CDCT	16.2	2.43	18.63	26-Apr-12
8	ICRF	18	0.00	18.00	05-Feb-10
9	ECRH	2.6	0.10	2.70	01-Oct-12
10	ICHV	6.9	0.00	6.90	15-Mar-11
11	SPIDER 100KV PS	0	0.71	0.71	15-Dec-10
12	ECHV	1.1	0.00	1.10	31-Oct-12
13	DNPS	9.7	0.00	9.70	22-Apr-09
14	DNBI	13.1	0.00	13.10	22-Mar-10
15	SPIDER Beam Dump	0	0.20	0.20	15-Dec-10
16	DIAG-1: XRCS Edge	4.48	-0.15	3.89	06-Apr-12
	DIAG-2: XRCS Survey				17-Sep-12
	DIAG-3: LPP09				19-Apr-13
	DIAG-4: BES				24-May-13
	DIAG-5: ECE				15-Oct-12
Total credit (kIUA)		245.98	13.34	259.32	(Signed PA: 242.63)

Table B.2.2.1 Procurement Packages of ITER-India - the PAs for the green ones are already signed and the yellow ones are yet to be signed.

sing rate of IWS materials which is reviewed and approved by IO (IDM Ref: 45M9ZE v1.0). IO has finalized the dimensions of test coupons proposed by IN-DA IWS group. Engineering drawings of test coupons were approved by IO and manufacturing drawings are under preparation at IWS manufacturer. IWS group procured some components to upgrade the system.

Mock-up Manufacturing:

(a) Mock up 1: Mockup-1 is manufacturing of three IWS blocks, each with three shield plates (VS6-PS1). Its aim is to demonstrate and validate the manufacturing process and block pre-assembly process.

(b) Mock up 2: Mock up-2 represents a part of the Vacuum Vessel Inner Shell, FSH (Flexible Support Housing) and Poloidal ribs. The purpose of mock-up-2 is to demonstrate and validate the assembly process of IWS blocks on VV sector for Poloidal Segment-1. Manufacturing of Mockup 1 and 2 is completed and reports are approved by IO. ITER-India has done some modification in T type poloidal rib to simplify the design of mock up 2 and validate block assemble as per actual vacuum vessel.

Anti-Rotation Locking Washer & Lifting Bolt Validation:

The purpose of the anti-rotation locking washer is to prevent the rotation and coming out of the fasteners due to vibration of the vessel during operational stage. The basic design of M30 bolt has been changed to incorporate the flange to facilitate the welding at 2 or 3 locations between flange and anti-rotation locking washer. This will prevent the formation of cracks on bolt head. The overall length of the bolt can also be reduced. An Analysis was carried out to validate the design of M30 side bolts when they are used for lifting the IWS blocks. The purpose of the analysis was checking the impact of lifting on the bolt head. It was performed for only axial loading case. For in board side the load applied was 1.5 times the weight of block i.e. 1.5 x 165 kg while for outboard side it was 1.5 x 880 kg. The results were then validated by actual trials of the block under different loading conditions.

Saturation Magnetization Test (SMT) for SS 430: SMT for SS 430 was carried out at UGITECH, Uguine. This test was performed according to the IEC 60404-04 "Magnetic Material-Part 4: Methods of measurement of dc magnetic properties of Iron & Steel". Cylindrical bar samples of size ~ 13mm x 250mm were cut in Industeel, France and sent to UGITECH for SMT. Test reports of this test have been submitted by Industeel, France. Results of this test meet the requirement

defined in Product procurement Specification for SS 430 (1.6 T– 1.66T).

Preparation of Vibration Test : During the plasma operation, IWS will be subjected to vibrations due to the plasma disruption and seismic loads. Thermal loads will cause vibrations that will tend to reduce the value of pre-loading. ITER-India has planned to study the effect of vibration and calibration of test setup before final testing of the IWS block. For this test IWS block will be placed on vibration table and subjected to vibration conditions similar to ITER vacuum vessel while in operation phase. Loss in preloading will be measured using strain gauges.

B.2.4 Cryostat & VVPSS - ITER WBS 2.4

Figure B.2.4.1 shows the ITER cryostat which is a very large vacuum vessel of 29m in height and diameter and will refrigerate the ITER toroidal and poloidal field magnets and the central solenoid at liquid Helium temperatures (4K). The ITER cryostat will be the biggest refrigerating vessel ever built in the world. ITER-India "Cryostat & VVPSS" group is involved in following activities:

Cryostat Procurement Arrangement (PA) signature

- Review of PA documents for Cryostat.
- Signature on Cryostat PA by Project director on 6th September 2011.

Cryostat Procurement activity:

- Industry Pre-qualification through EoI
- Scope appraisal meeting (SAM) with Industries for ITER Cryostat
- Project Realization Plan meeting for ITER Cryostat
- Bidder selection (BHEL and L&T)
- Generation of two part tender documents for main Cryostat and Temporary Site Workshop
- Call for tender documents on 8th Nov 2011
- Pre-Bid meeting with Industry on 7th Dec 2011
- Bid-submission by Industry and part-I opened on 29th Feb 2012
- Techno-commercial evaluation of bids is going on.

Design activities :

Design of transporter frame for Cryostat Lower cylinder : Transporter frame has been design on the basis of baseline model. It is designed to take the load of Lower cylinder including its fabrication frame. For taking the load, roller supports are provided below the transporter frame, whose positions have been optimized during the analysis.

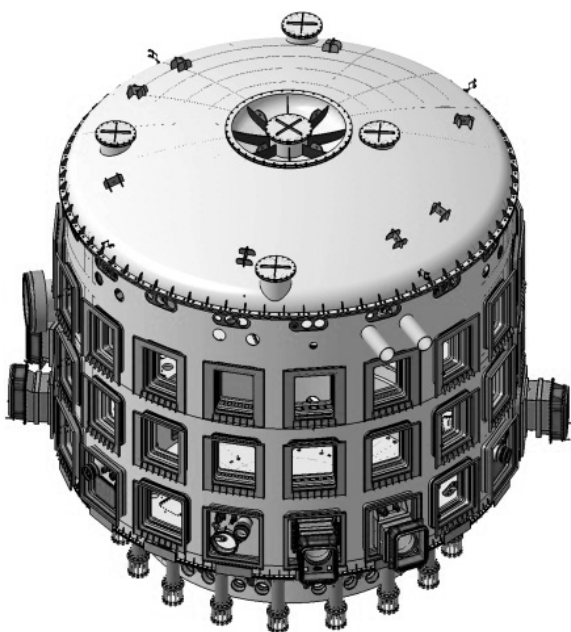

Figure B.2.4.1 shows the ITER cryostat

Saddle support design of VVPS Tank (Vacuum Vessel Pressure Suppression Tank) : Saddle support for VVPS tank has been design and optimized to reduce the weight and fabrication cost. For designing ASME code is used and ANSYS analysis will be performed to check the stresses and maximum deflection.

Relief line optimization of VVPSS : Relief line has been optimized to reduce the requirement of oblong bellow and reduce the fabrication cost. ANSYS Fluent has been used to check the pressure drop for flow optimization.

Conceptual Design Review of VVPSS : This review has been completed on 30th November 2011. The Vacuum Vessel Pressure Suppression System (VVPSS) shown in Figure B.2.4.2 consists of a large suppression tank (~6m dia. and ~46 m length), containing enough water at room temperature to condense the steam resulting from the most adverse in-vessel coolant leaks, thus limiting over-pressurization of the vacuum vessel within 0.15 MPa absolute.

VVPSS fabrication study: This study two stages of fabrication and assembly (i) Factory Fabrication at India (ii) Assembly inside Tokamak building at France. Detail study for VVPSS fabrication and assembly is going on. VVPSS detail study involves following major activities: (a) Segmentation study and tolerance planning (b) Welding study and assembly plan (c) Transportation study (d) NDT requirements, inspection and quality plan. Cryostat temporary workshop design

VVPSS consists of following Components:

- VVPSS Tank
- Distributor Assembly
- Relief Pipe
- Bleed Line with UHV Gate Valves
- Rupture Disks assembly
- Support Structure
- Oblong Pipe

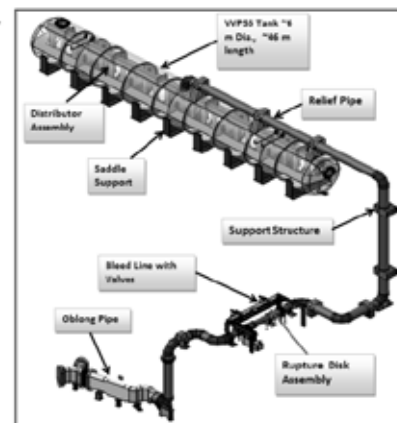

Figure B.2.4.2 Conceptual design of Vacuum Vessel Pressure Suppression System (VVPSS)

and Input document preparation for Building permit and environment permit: Cryostat Temporary workshop is needed for Cryostat segment assembly at France. The tentative size of workshop will be 44mX110m area and 30m height. Designing of temporary workshop is completed with the help of engineering services and inputs are generated to get Building permit at France.

B.2.5 Cooling Water system - WBS 2.6

The Component Cooling Water System (CCWS) and Heat Rejection System (HRS) were redesigned to meet the functional requirements and the design has been approved for implementation through Project Change Request (PCR) – 336. Moreover, PCR – 329 has been introduced to freeze the functional requirements of CCWS and CHWS. The Process Flow Diagrams and System Requirement Documents of CCWS, CHWS and HRS have been revised and have been approved by ITER IO. The Preliminary design of ITER Component Cooling Water System (CCWS), Chilled Water System (CHWS) and Heat Rejection System (HRS) has been continuing. An interim preliminary design review was held. The following is the list of documents / drawings prepared as the part of preliminary design. (i) Design Calculations and Thermo Hydraulic Analysis (ii) Piping and Instrumentation Diagrams (iii) Design Description Document covering all aspects of design (iv) Water treatment scheme (v) CMM and GA drawings of B67, B68, B69, A64 (vi) I&C Diagrams (vii) Electrical Diagrams (viii) HAZOP Analysis (ix) RAMI Analysis (x) Piping Stress Analysis (xi) Equipment categorization as per PED guideline. The Preliminary Civil design of Hot and Cold Basin has been carried out and following documents / drawings have been prepared (a) Design Basis Report of Basins (b) GA Drawing of basins (c) Design report of hot basin (d) Design report of cold basin (e) Reinforced



Concrete Drawing of Basin (f) Bill of Materials of the Basin. The pre-qualification process to shortlist the bidders for the tender 'Detailed design, engineering, procurement and safe delivery of ITER Component Cooling Water System, Chilled Water System and Heat Rejection System at ITER site' has been initiated through Expression of Interest.

B.2.6 Cryo-distribution & Cryo-line – ITER WBS 3.4

ITER Cryo-distribution and Cryo-line system : ITER-India is responsible for realizing the in-kind contribution of system of cryolines and cryo-distribution for the ITER project. This intermediate system distributes the cryogenic cold power to the different applications, namely, superconducting magnets and cryopumps. With the completion of the "Procurement Arrangement" formalities, ITER-India has entered in to the procurement phase for realization of the system of cryolines. ITER-India has successfully completed the design development and review of the prototype cryoline along with industry. The test infrastructure for executing the performance test for the ITER prototype cryoline is presently in progress. The procurement arrangement formalities for the cryo-distribution system are in progress with ITER organization. The risk analysis of one of the important component, which is first of its kind, that is, the cold circulator is in progress. The cold circulator will be tested with joint international collaboration. ITER-India cryogenics group is also working for the simulation of pulsed thermal load management of fusion machines in the perspective of cryogenics. A significant development in the understanding has been made for an efficient mitigation of the pulsed thermal loads.

B.2.7 Ion Cyclotron Heating & Current Drive Sources - WBS 5.1

RFPS package : To demonstrate the performance of world-wide available high power tubes (Tetrode/Diacrode) for ITER application, an R&D program has been setup, considering single chain experimentation at 1.5 MW/3600s/35-65 MHz. Based on the outcome of this program, ITER Prototype & 8 nos. of Radio Frequency Power Sources will be built and will be offered to ITER organization for their acceptance. During this reporting period, the major emphasis was given to assemble, integrate and test the system up to pre-driver stage amplifier and to develop/procure the necessary infrastructure for very high power test facility at ITER-India lab, which will be unique in nature. Finalization process for awarding contract related to driver and final stage amplifiers using Tetrode and Diacrode technologies were also completed during this period, which is one of the important steps towards our mission. Output & input circuits for the pre-driver stage amplifier is assembled & integrated with other sub-systems /

systems / auxiliaries and low power test up to few kW range was conducted. Different configurations of the input circuit for pre-driver amplifier studied and optimization of the same is underway. Local Control Unit (LCU) for R&D source is under development along with industrial partner. Signal list & its tag naming and its associated functions are finalized. PLC & PXI systems mounted on the Rack with internal wiring, delivered to ITER-India lab. Logic has been finalized & implemented on PXI-7831 board for Interlock. Testing of Interlock logic has been carried out with simulated signals. Data acquisition & Display module are under development. After testing of acquisition & display module, integration part of PXI & PLC systems will be carried out. For development of driver & final stage amplifiers, bid received from potential suppliers. Detailed discussion held on the responsibility sharing between ITER-India and bidder throughout the project which is completely new working approach, especially in MHz frequency range. Different operational strategies & plans, technical aspects, time schedule, risk mitigation plan etc. were also discussed in depth. Technical Evaluation Meeting with the bidders, in presence of national & international experts was arranged during 20-24th June 2011 and discussed the bid in detail, queries generated, and clarified through several discussions/communications. Price bid was opened after getting clearance of all the technical issues. Subsequent meetings were arranged with the bidders to clarify other terms & conditions and finalized the bidders for awarding the contract. A full-fledged facility is being developed for testing amplifier at MW level. All necessary components/equipment/systems/sub-systems, lifting mechanism, grounding scheme, equipment power, cooling need etc. finalized and procurement activities initiated for all auxiliaries including very high power RF systems, like 1.5 MW dummy load, 3.0 MW Mis-Matched Transmission Line (MMTL) system, 3MW/12 inch transmission line components, directional couplers etc. In-house development in the areas of power supply, transmission line system, high power dummy load, high power RF amplifier, RF finger contact etc. initiated. Simulation for RF amplifier in the frequency range 35MHz - 65MHz completed using high frequency software MWS & HFSS. Realization & conversion of RF design for the cavity of driver stage amplifier into mechanical design is also completed and made ready for fabrication. Finger contacts for high power (1.5 MW) transmission line system designed & developed indigenously. Interface issues with RFPS package at ITER site were detailed out and specific issues are identified which will be addressed during R&D program.

B.2.8 Electron Cyclotron Heating (ECH) system - WBS 5.2

As a part of the in kind contributions to ITER internation-

al project, the Indian Domestic Agency (ITER-India) has a procurement package (EC Gyrotron Source Package) whose main scope is to supply a set of two high power (170 GHz/1MW/3600s) Gyrotron sources including auxiliary systems. The execution approach includes procurement of high power tubes on functional specification basis and establishment of complete integrated performance. A Gyrotron test facility with prototype auxiliary systems is being developed to establish the integrated Gyrotron system performance. During the FY 2011-12, the EC Gyrotron Source project has progressed further with various equipment and component procurements having been initiated for establishing the ITER-India High Power Gyrotron Test Facility (IIGTF). From the procurement package point of view, the package has crossed the first formal design milestone (Conceptual Design Review) will be held later by ITER. Review preparations for the Contractual Procurement Arrangement are on-going. Some of the main highlights of the activities carried during this period are summarized below.

Activity related to Gyrotron Source System & Test Facility : Development of Prototypes/Pre prototype/Lab setups/Equipment for IIGTF is in progress

Control System : A Pre prototype Mini Local Control Unit (LCU) is planned to be developed for IIGTF (Figure B.2.8.1). Procurements for main subsystems such as the PLC, PXI systems are in advanced stage with orders placed/being finalized. Pre prototype signal conditioning units with different design concepts are being developed through task proposals with industry collaboration. An engineering design task for the LCU is also in pipeline to be executed with industry collaboration.

HV Gyrotron Protection & Measurement Systems : An ignitron protection crowbar is planned for IIGTF. Based on the in-house design, an industrial prototype for Ignitron Crowbar protection System is being procured. Orders for the same are being finalized. A new improved design of Ignitron Trigger Module for reliable firing of crowbar unit is also being developed. Various HV test & measurement equipment such as the HV breakdown tester, HV probes etc. have been/being procured.

Auxiliary PS : Pre prototypes identified and procurement specifications are being developed

Diagnostics : A low power mm Wave setup in D-band is planned for IIGTF. Main equipment such as the low power

source, HE11 mode converter and waveguide components have been/being procured. An mmW Spectrum Analyzer and detectors have been procured for Gyrotron output Frequency & inline Power Monitoring (Figure B.2.8.1). A task for Mode Purity diagnostic, data modeling and analyzing is prepared and is being perused with academic institutions

High Power Waveguide Transmission Line Components : Preliminary Requirements & Configurations have worked out.

Mechanical Design & CAD activity: Requirements and conceptual design for the IIGTF Cooling Distribution System is being finalized as a preparation towards tendering. Thermal Hydraulic Analysis of Gyrotron Collector has been carried out and established a preliminary design understanding (Figure B.2.8.3). CAD models of Gyrotron set up and IIGTF layout have been prepared.

Lab building for IIGTF : Lab building for IIGTF is now ready for equipment and activities to fully occupy and establish the test facility have been initiated.

Activities in relation to the procurement package with ITER

(i) As per the approved Configuration management policy of ITER, a Conceptual Design Review (CDR) is to be conducted by ITER Organization (IO) before proceeding for issuing procurement Arrangements to Domestic Agencies for a Functional Specification type package. In line with the policy a CDR for the EC RF Sources and HVPS has been conducted by ITER-IO with an expert panel constituted to review w IO

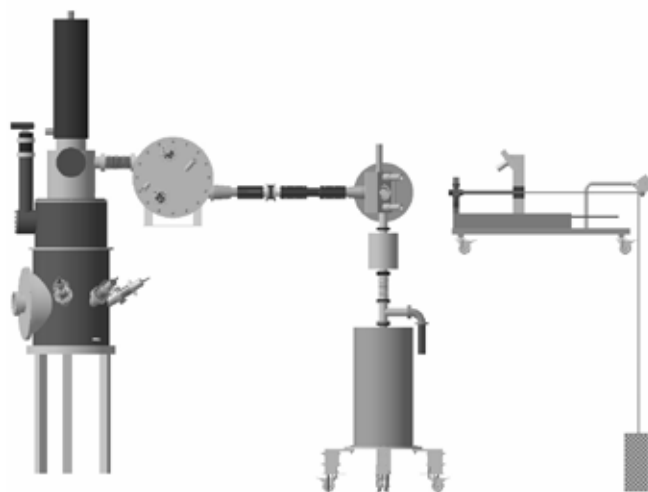

Figure B.2.8.1: BLOCK diagram of diagnostic setup for Gyrotron frequency and power monitoring

& involved DAs work during Jun-2011. A conceptual design report has been presented before this review panel for IN-DA EC Gyrotron package and supported the IO in clearing the first design milestone (CDR). Subsequent to the CDR, preparations for the contractual. (ii) Procurement Arrangement is on-going with the first draft of Annex-B are under discussion between IN-DA and IO.

Other developmental Activity : Preliminary design and simulation studies have been initiated towards a solid state crowbar protection system.

B.2.9 Diagnostic Neutral Beam (DNB) - WBS 5.3

Diagnostic Neutral Beam (DNB) for ITER, the probe beam to support the Charge Exchange Recombination Spectroscopy (CXRS) diagnostic is the only diagnostics for the measurement of Helium ash in the ITER machine by monitoring the light emitted from the excited helium atom following charge exchange with the beam. The 100 keV (H) (DNB) has a mandate to deliver 18-20 A of neutral beam current, with 5 Hz beam modulation having 3s ON – 20s OFF duty cycle over ~22 m transport length. ITER-India DNB group is engaged in generating the built-to-print design of the whole DNB system in collaboration with ITER-IO and its partners. The activities are broadly divided into three major categories: A. ITER DNB related, B. INTF related and C. SPIDER (Collaboration with RFX, Italy) related. Following are the major highlights of the activities and achievements over the past one year in these three categories.

ITER-DNB related : The focus of the activities in this category are mainly integration – interface design of different components considering ITER's remote handling concept, in the areas of, i) Beam Source (BS) with High Voltage Bushing (HVB); ii) movement mechanism of BS, Calorimeter; iii) alignment system for Beam Line Components (BLCs); iv) electrical and hydraulic interfaces of Residual Ion Dump (RID); v) interfaces and remote handling tools for BS, (BLCs), Exit Scrapper (ES), HVB; vi) DNB HV Transmission line; vii) DNB Vessel; viii) Passive Magnetic Shield (PMS) and ix) thermocouple lines for beam diagnostics and monitoring beam facing components health. Apart from the above mentioned areas, a design for the Cs delivery system for ITER BS has been proposed from the consideration of a possibility of injecting the Cs vapor from an oven located outside the vacuum envelope of the BS, thereby ensuring an ease of Cs refilling and oven maintenance. The design of such a delivery system involves long transmission path of lengths ≥ 4 m, from ambient to vacuum. A combination of manual

and remotely operated high temperature valves has been incorporated in such a way that the Cs refilling or oven maintenance can be done without breaking the ion source vacuums. Removable joints in the oven heating elements are provided at specific locations to cut remove the Cs oven for ion source maintenance. The remote handling of the Cesium (Cs) oven modules in such complex interface dominated space envelope of Diagnostic Neutral Beam (DNB) source for ITER is a challenge. Therefore, to generate operational data for such Cs delivery system, a Cs oven with 5 m long delivery stem with co-axial vacuum envelope has been fabricated in negative ion lab at IPR and the proof-of-principle experiments are now under way (as shown in figure B.2.9.1). Cs delivery over a length of 5 m has already been observed at an elevated temperature of 220°C. Presently going experiment incorporates an additional feature of multiple nozzle distributor based Cs delivery into the ion source which might help in reducing the need of multiple Cs ovens in large ion sources like ITER. More experiments are being carried out to fully characterize the proposed Cs delivery system for DNB source.

INTF related : The INdian Test Facility (INTF) in the Institute for Plasma Research, Gandhinagar, Gujarat having floor area, ~ 600 m² is dedicated to the “Full characterization of the Diagnostic Neutral Beam” for ITER. The prime objective of the facility is to install a full-scale test bed for the qualification of all diagnostic neutral beam parameters and the behaviour of the beam line components prior to installation and operation in ITER. The Test Facility conceived as a collaborative effort between ITER India and ITER Organization is integrated into a wider landscape of domestic research on neutral beams in India. The Indian Test Facility will replicate all aspects of ITER's diagnostic neutral beam except remote handling and vessel configuration. The civil structure facility is completed and the foundations are now in place for the beam line vessel and its components. Initial design for cylindrical vacuum vessel along with required interfaces with different BLCs and cryo-pumps are completed. Procurement procedure started for vacuum Vessel. Preparations of Technical Specification for procurement of BLCs along with the prototyping of them are in progress. In this regard, ITER-India signed a MoU with NFTDC for production of prototype neutralizer panel & Heat Transfer Element (H-T-E) for Beam Line components. So far, NFTDC already produced 33 Heats (100 kG each) of CuCrZr. Chemical analysis (Except O₂ analysis) is carried out for all those heats and found meet the ITER requirements. Tensile testing for all heats at room temperature are in process. Thermo-mechanical experiments were carried out by NFTDC on CuCrZr material to achieve required Mechanical Properties, grain structure &

near net components w.r.t final dimension. Deep Drilling trials (up to 2meter length) on Neutralizer panels & RID H-T-E's are on-going. Electron beam welding trials for welding of CuCrZr – Ni ,Ni –SS316 ,OFHC –Ni etc. are also under process. HV bushing (HVB) for INdian Test Facility (INTF) was designed. It is connected at rear end of the DNB vessel. In present design, Vespel is proposed as an insulator for isolation between central high voltage region (-100 kV) and DNB Vessel (0 kV). Electrostatic shields are provided for equal potential distribution and avoid electric breakdown. In a parallel effort, prototype HVB was designed to realize experimental know-how and behavior of metal & non-metal combination in high voltage and vacuum environment. Electrostatic and mechanical analysis has been carried out. The concept of FRP-Metal connection is developed. The validation of the design is ongoing to establish the bond strength and vacuum compatibility. Procurement procedure has been started for different sub-components of proto HVB. Inquiry for the ceramic ring of diameter 790mm (approx.) has been placed to vendor.

SPIDER related : SPIDER Beam Dump is an Indian contribution to SPIDER facility at RFX, Padova, Italy. Detailed engineering design has been carried out by DNB Group. Figure B.2.9.2 shows a view of 3D model of SPIDER Beam Dump. The design includes thermo-structural analyses, modal analyses and seismic analyses. Structural verification has been carried out w r to ITER Structural Design Criteria for In-vessel Components (SDC-IC). The design was presented in Final Design Review (FDR) held at ITER IO on 18th October 2011. The Design has, in general, been accepted by the review panel and recommended to go ahead with the procurement activities. Technical specifications have been prepared and communicated to the companies, short listed as eligible parties.

B.2.10 Power Supply Group

The Group is responsible for design, development and supply

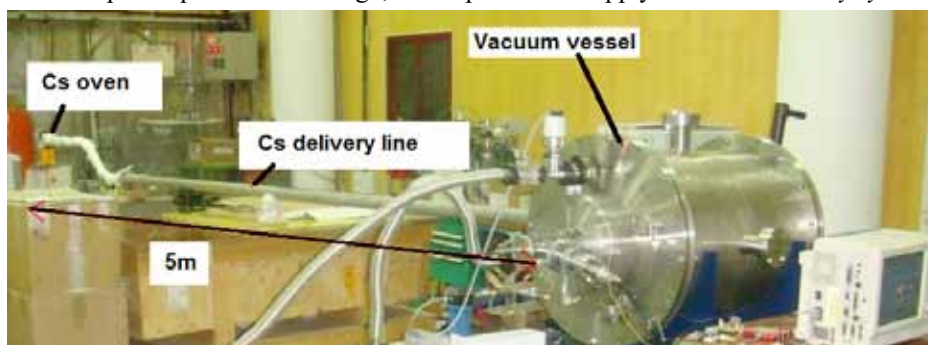

of power supplies for the Diagnostic Neutral Beam (DNB), the Ion-Cyclotron (IC) System and the Start-up Electron Cyclotron (EC) System of ITER. These systems will be first installed in the Indian Test facility, to test corresponding systems to full operational parameters, before delivery to ITER. A high voltage power supply shall also be supplied for the SPIDER, the Neutral Beam Test Facility at RFX, Padova, Italy. Preliminary design review (PDR) for DNB Power Supply system (DNBPS) was convened on 26th & 27th May 2011 at ITER organization, Cadarache. The DNBPS system is a complex combination of 100kV, 75A high voltage, 4kA high current, 250kW RF and other smaller systems with associated integrated installations and controllers. It also involves a complex HV transmission line with embedded Nuclear Safety important components. The proposed design and related interface aspects were approved by the international review panel. There was only one Category-1 chit from the PDR, that issue has been addressed and PDR is formally closed. ITER credit of 1kIUA has since been received for the completed works. The system is onto procurement phase since then. The design of 100kV power supply for the SPIDER system was completed during the period. Various technical and interface issues related to the system were discussed during second Interface management meeting (IMM-2) held at RFX-Padova during 21-22 September, following the third meeting (IMM-3) at ITER-India during 14-16 February 2012; with participation of RFX, INDA, F4E and IO. Majority of interface issues are resolved and enters the Call for tender

Figure B.2.9.2 shows a view of 3D model of SPIDER Beam Dump.

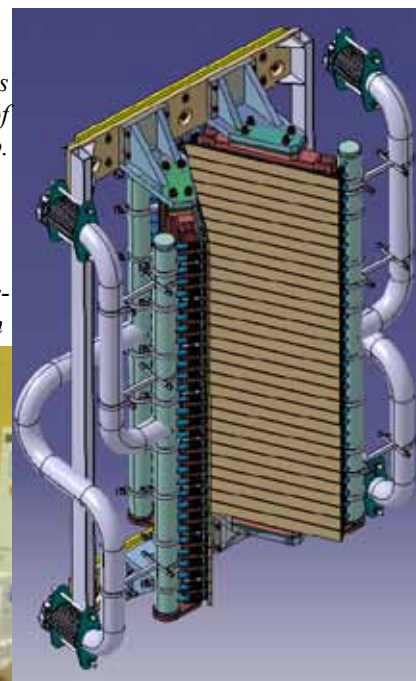

Figure B.2.9.1 Cesium delivery system

stage following approval of Procurement description document by the ITER Organization. Preliminary design for Power Supply of Ion Cyclotron system approaches its final stage. These are high voltage power supplies with dual, separately controllable outputs. Related design and interface documents submitted to IO, to initiate design review procedures. Preliminary design review in near future. On the Electron Cyclotron Power Supply front, the quantity of power supply units has been increased to 5, after a project change request. Its design process is in progress. A full scale industrial prototype power supply for the IC system is being developed, with M/s ECIL, Hyderabad with technology transfer from IPR. Manufacturing of Cast Resin Transformers and Switched Power Systems have made substantial progress. A new controller has been designed and a prototype has been tested successfully.

B.2.11 ITER-India Diagnostics – ITER WBS 5.5

Considerable progress was made towards the finalization of the Procurement Arrangement (PA) with ITER for the supply of our Diagnostic items. The first phase of the PA has been signed for the edge plasma X-ray spectroscopy system –XRCS (edge), following successful completion of the Annexure-B defining the functional specification and the technical scope of this system. The XRCS (edge) spectrometer will be integrated at the back of an upper port plug, directly coupled to the torus vacuum and will be deployed for achieving high performance plasmas in ITER. The concept design of the system was presented in the 20th meeting of the ITPA topical group on diagnostics, held in Noordwijk, The Netherlands. The Concept Design Review (CDR) for the XRCS (Survey) spectrometer system was also held this year. The previous year work on the development of software for simulating the full spectrometer to accomplish optimised design was completed jointly with ITER. The design and performance assessment of the spectrometer for the ITER H-mode reference plasma will be presented in the 19th High Temperature Plasma Diagnostics conference at Monterey, USA. The CDR for the ECE Transmission and Receivers system was also held with the ITER-India members contributing the results of calculations and analysis performed in the previous year. As a part of engineering support to IO, load calculations, structural assessment of ECE system, ECE diagnostics building room layout and power requirements for the ECE diagnostics room were performed by IN-DA engineers. The IN-DA and US-DA ECE teams conducted joint experiments on the transmission of corrugated waveguides and the possibility of calibrating the ECE detection over a broad range of

wavelengths required for ITER. The work has identified the combination of Bragg reflection and water vapour absorption as a concern for higher frequencies. These results, during the CDR process, lead to the recognition of the need for tests on alternate types of waveguides for the ECE transmission lines (TL) and evaluation of S/N for an integrated system (i.e. one comprising the TL, interferometer and detector). Efforts are underway to pursue this work using facilities in EU and US. IN-DA's planning for delivering the single port plug (UPP-09) in its scope had to be revised. This was due to the decision by all the ITER participants to jointly identify a common party as a Port-plug Structure Supplier (PSS) to undertake the fabrication for all the port plugs. An MOU to this effect is to be signed in the near future. In-DA had been encouraging Indian industries to prepare themselves for this opportunity by disseminating the necessary technical and procedural information from ITER to our industries. An expression of Interest has been sought. The effort to identify appropriate industries for nomination to the ITER organization is near completion. The CDR for the Beam Emission Spectroscopy (BES) is planned to be held by the end of the year 2012. The analysis performed in the previous years on the expected S/N in the Beam emission light were presented at a Satellite meeting during the 20th ITPA diagnostics meeting in The Netherlands. In anticipation of the needs for the CDR of the BES diagnostics, experiments have been initiated, in collaborations with teams in IPR, to study the polarization dependence of a few types of spectrometers in use on ADITYA Tokamak for the study of H-alpha spectrum. The wavelength dependence of the s/p polarization transmittance has been recorded. Collaborations under the IN-EU agreement, IN-DA will be working on CXRS/BES related experiments on JET. The equipment procured in the past year for initiating test and prototype experiments are being assembled in the IN-DA Diagnostics Lab in IPR campus. Characterization of Bragg effects in corrugated waveguides and verification of coupling efficiency of low frequency waves to waveguide sections while using ellipsoidal mirror arrangements are the initial ITER-relevant experiments slated to be performed by December 2012. Preliminary results have been obtained using the software acquired in the past year. The computation of ECE radiation at an oblique LOS in ITER was completed using the NOTEC code. Presently the effect of non-thermal electrons on the ECE emission is being attempted. The simulation of mode conversion during propagation of electromagnetic waves in waveguides due to gap in a WG section was undertaken using the COMSOL software. Some of these results will be presented in the EC-17 conference.

B.2.12 Activities of the Fusion Physics, Information Technology and IO-DA coordination group

Physics Modeling : The modeling activity for Disruption and Vertical Displacements in ITER using the TSC code, which was done earlier using a credited task (completed in 2010) was extended this year to investigate new yet unexplored areas. During this work, the focus was on developing controlled plasma shutdown techniques in ITER using Killer Pellets or Massive gas injection. This has been one of the critical areas in ITER which is still in R&D state as all the proposed shutdown techniques have there inherent problem areas, which have to be overcome to ensure a safe plasma current termination with minimum Runway and Halo currents. Modeling has been started in this area using the TSC code, which will be presented in the IAEA FEC-2012 Conference at San Diego.

Information Technology : The major initiative in the areas of Information Technology in ITER-India was in for implementation of SAP Enterprise Resource Planning software. As already mentioned in the last years report SAP was being implemented through M/s Ressaux Tech and Arteria Technologies Ltd. through a DGS&D rate contract. The contract was awarded in March 2011 and the implementation started in May 2011 with software professionals from Arteria working in the ITER-India premises under our supervision. The implementation has been done across IPR, ITER-India and FCIPT and will also be rolled out to CPP in the near future. The servers are housed and maintained in the ITER-India premises and are accessed across all IPR constituents through VPN over dedicated leased line connections. In the initial phase we have implemented the Material Management (MM), Human Capital Management (HCM) and Finance and control (FICO) modules of SAP and Project System (PS) module is presently being implemented in the second phase. IPR, ITER-India and FCIPT have gone live on SAP from 02 April 2012 with all Financial, material and human resource transactions being done now using SAP. With this we are the first among the DAE organisations to have successfully implemented SAP. For SAP, the host servers are stationed in ITER-India premises on a high performance IBM Blade Center E with 11 servers each with dual quad core processors, between 16-64 GB RAM and 5 TB storage space. Also a dedicated backup and storage server is installed with 20TB storage space to take backup of all critical data. The servers are virtually 100% available and backed up by UPS and DG power backup.

IO-DA Coordination, Cost Containment and STAC activities: A total of 22 ITER Head Coordination Meetings (IHCM) were held in 2011. These meetings are held bi-

weekly through Videoconference. IHCM is the highest IO-DA decision-making body in ITER and takes most high-level management and technical decisions. Project Director, ITER-India and Indranil Bandyopadhyay (IBY), IO-DA Coordinator are members to the IHCM from India. IBY was also member of the cost control task force (CCTF) of ITER and participated in 8 meetings of the CCTF. IBY along with Prof. Abhijit Sen also participated in the 2-day deferral workshop at Cadarache in September 2011 to develop an effective deferral strategy to construct ITER within the capped cost. IBY is an expert to the ITER Science and Technology Advisory Committee (STAC) of ITER and participated in 2 STAC meetings in 2011. The STAC meetings are held twice every year and it reviews the progress of ITER project and advises the ITER Council on scientific and technological issues. IBY has participated in all 11 STAC meetings so far since its inception in 2007.

B.2.13 Activities of the Project Office

Schedule related activities on various packages are continued to be regularly updated as per project progress using Primavera. Project Schedule Implementation Task Force (PSITF) activities are on-going in collaboration with ITER-IO for making a Strategic Management Plan (SMP) for effective monitoring & control of the project. To suit the SMP requirements, Detailed Work Schedule (DWS) of various packages are updated. Preparation and review of documents towards finalization of Procurement Arrangements (PAs). The PAs signed in 2011-12 are of Cryostat and Later Delivery Cryolines. Risk register and Risk Management Plans (RMPs) made for IC HVPS and approved by IO. Participation and support in the Configuration Management and Change control activities for reviewing the Project Change Requests (PCRs) due to the design improvements, new procedures & documentation, impacts on scope, schedule and cost. Participation in SAP Implementation related activities. Activities on Earned Value Management (EVM) will now be integrated with SAP Project Systems Module. Package Progress Meeting (PPM) is organized every month for regular assessments of each package progress, schedule variances, recovery plans, interface issues etc., and common Issues are discussed in ITER-India Management Meeting (IIMM) for their best possible solutions and if required these are reported to higher management for necessary action. Various summary reports are prepared for summarizing the activities of the project and also the budget related reports are prepared for managing the expenditure. The Contract for Cranes has been placed for ITER-India Test Facility (INTF). Involvement in Intellectual Property (IP) board for management of IP matters at ITER-India.



B.2.14 Activities of ITER-India Design Office

ENOVIA Data base use at ITER-India: Design activities in Synchronous mode using ENOVIA for CWS, DNB, DNBPS, ICHVPS and VV-IWS. 30 DETs were exchanges between IO and DA and associated Technical support provided

- 3 Design collaboration implementation forms (DCIFs) have been signed with IO
- Design Modification and reconciliation completed in ENOVIA for IC HVPS CAD data
- Design development of wave guides & Polarized splitter and Drawing generation of EPORT_EQPORT09 for Diagnostic group
- Integration of all systems CAD models from different group in ITER-India Lab model is on going
- Full size modeling and Modal Analysis of Cryostat
- Seismic analysis of IC HVPS system (Power Supply Group)
- Non-linear transient thermal analysis of tungsten hot plate ionizer of multicusp Q machines

Meetings: All fortnightly Change Control Board (CCB) and Technical Co-ordination Meetings (TCM) handled on the behalf of ITER-India, and coordinated information between affected packages of ITER-India and IO. Total 148 PCRs have been handled in CCB meetings, and subsequent internal meeting with the higher management and the project package members to arrive at the decision on the PCRs. CAD Users Meetings were organized to assess work load and resources, CAD WG10 Meeting in June 2011. Also weekly DO co-ordination meeting with IO. "ANSYS core" group regular meeting to resolve the analysis issues of the package

Licenses: Maintenance of CATIA, ANSYS, HYPERMESH, Block SIM XFMEA, MathCAD, 3DVIA and ENOVIA licenses and Procurement of 11 CATIA licenses and 1 ENOVIA License on lease for FYI 2012-13. I-RUN licenses procurement is in final stage.

Hardware: Maintenance of the all Design Office workstations and Servers, up gradation of hardware and software for old machines. Procurement and installation of 7 more workstations and 8 Desktop machines completed.

Training: (i) ENOVIA Certification Training: - 28 Key CAD users ENOVIA training including 8 from Supplier's have been completed, of which 20 as Designer-B and 8 as Designer-A by 2 certified Trainers of Design Office. (ii) CATIA Training - CATIA Training for ITER-India staff from beginners to experts in three phases, each phase comprising of 4-5 days training for 12 Candidates. (iii) Staff skill enhancement

Training : HYPERMESH – basic training (3 days) and two days MathCAD training also arranged

B.2.15 Quality Assurance Activities

- Internal Auditor for QMS program has been organized at ITER-India by QA (Quality Assurance) division. More than 5 (five) employee have successfully certified as an internal auditor
- Participate in the SQAWG (Safety and quality assurance working group) meeting at IO and gave the presentation on the 1984 Quality Order implementation at DA (Domestic Agency)
- Two days awareness session on IO (ITER Organization) Quality requirement has been organized at ITER-India by QA (Quality Assurance) division. Mr. David Sands IO QA (Quality Assurance) division head was the invitee.
- QMS (Quality Management System) awareness training has been given to various division like PMO (Project Management Office), DO (Design Office), Purchase, DNB etc.
- Various Quality procedures have been prepared and finalized. (Configuration procedure, Communication procedure, etc.)
- Potential supplier's audits have been conducted for CWS (Cooling water system) PA. More than 12 suppliers have been audit.
- Presentation for "1984 Quality order implementation" has been given in IIMM meeting.
- Conduct the Quality audit for the material supplier. INDUS-TEEL France, is the material supplier who is supplying the SS 304B4 material for VVIWS project.
- Carry out the material inspection and factory acceptance of SS 304B7 at Bridgeville, PA, USA and also take part in finalization of applicable Quality procedures of CPP and their sub-suppliers.
- Participate in the process qualification and sample production activity of the XM-19 material at Valbruna ITALY.
- Presentation on "Manufacturing and Inspection strategy at DA" has been given in the 32nd CMWG workshop at IO
- Participate in VVIWS MRR at Bangalore, TPI (Third party Inspection) agency kick off meeting, IIMM meeting, PPM meeting, Tender review meeting for CDCL, PTCL etc.
- Carry out the process qualification of Inconel – 625 materials at CPP, Reading US
- Participate in the factory acceptance of 4th, 5th, 6th, 7th and 8th Shipment of SS 304B7 at CPP US
- Reviewed various NDT (Non-Destructive) procedures from the sub-contractor
-

B.3. Centre of Plasma Physics - Institute for Plasma Research (CPP-IPR), Guwahati

B.3.1. Theory & Simulation

Magnetized Plasma Sheath : The effect of ion temperature, magnitude of magnetic field and its orientation on a magnetized plasma sheath in a multi-component plasma is investigated. It is found that with the increase of the ion temperature and magnetic field strength there is a significant change in ion densities and energies in the sheath. It is also noticed that increase of magnetic field angle enhances the ion density near the sheath edge for a constant ion temperature. With increase in ion temperature and magnetic field angle, the lighter ion density near the sheath edge enhances and reverses for the heavier ion species. It has been observed that with increase of positive ion temperature, the lighter positive ion density peaks increase at the sheath edge and shift towards to the sheath edge for both with and without magnetic field. For heavier positive ions, in the absence of magnetic field, the density peaks increase at the sheath edge. But in the presence of magnetic field the density peaks increase at the middle of the magnetic field. For both the cases, the density peaks shift towards the sheath edge. It is also observed that in the presence of magnetic field, the fluctuation of density and velocity peaks decrease for lighter positive ions and increase for the heavier positive ions.

Time Evolution of 1D Plasma Sheath : Collisionless simulation of nonlinear plasma dynamics is one of the outstanding problems of plasma physics as well as strong challenge in computational physics. A model for the study of time-evolutionary sheath based on a simple and realistic one-dimensional kinetic Vlasov equation is proposed. Collisions and effects due to plasma surface interaction- such as secondary electron emission are neglected. The effect of electron to ion mass as well as temperature ratio on the sheath potential is studied. It is observed that the magnitude of potential drop decreases for low value of mass as well as temperature ratio. It is also seen that with time the presheath moves inward from both ends to the central equilibrium of the system. This is may be due to dependency of particle density on the plasma parameters. The sheath potential plays role of accelerating ions and excluding electrons so that the ion particle flux balances with the electron particle flux at the wall. The flux of ions to the wall is less due to small thermal motion of ions.

CFD Simulation and Benchmarking : CFD or computational fluid dynamics is a powerful tool to analyze the fluid problems numerically. The Navier-stokes equations are basically solved by one of the various available methods namely finite difference, finite volume, finite element etc. The Navier-stokes equations are coupled to the continuity equation.

A 2D CFD code has been developed for solving the standard lid driven cavity problem. The code has been written in MATLAB and it uses uniform staggered gridding. The code further aims to solve the problem in 3D and thereafter the 3D MHD problems. Benchmarking is done at Reynolds' number 100 with the paper of Ghia et al and the error level is minimized up to 10⁻¹¹. Adapted discretization method is the finite volume discretization method. Currently writing the code in 3D is in progress for the standard lid driven cavity problem itself.

Neutronics Modeling and Simulation : A computer cluster consisting of 24 nodes and a server has been assembled and parallel virtual machine (pvm) with various radiation transport tools and pre- and post- processing softwares installed during the early part of 2011 for neutronics modeling and simulation works of IN TBM and IN DEMO blankets. The tools and softwares include mcnp, Attila, Matlab etc. A workstation with 3D CAD tool solidworks has been installed for preparing geometry of components/devices to be used for neutronics analysis with Attila. After performing several usage validation calculations using 3D deterministic radiation transport code Attila, which solves the linearized Boltzmann transport equation, we have performed some preliminary neutronics design and analysis of the IN-DEMO blanket and ITER TBM. The solid geometry required for the calculations analysis has been prepared using a CAD modeling software called solidworks. As a first step towards complex geometry of a toroid, we have constructed toroidal cylindrical buildup of the complete IN DEMO in 1D using the radial buildup for IN DEMO. Several neutronics parameters like neutron flux profiles, tritium breeding ratio, etc. have been estimated using this model. We have prepared the 3D solid geometry model of the LLCB TBM and calculated some neutronics parameters using a simplified form of this model. In addition, we performed several parametric Monte Carlo simulations towards the design of a solid breeder blanket during the period of this report.

B.3.2 Dusty Plasma Laboratory

Negative ion production using cesium coated dust : An experimental setup to verify a novel concept regarding surface assisted volume negative hydrogen ion production using Caesium (Cs) coated tungsten dust into a hydrogen plasma is described here. Cs coverage on metallic surface reduces the work function and low work function surfaces produce more negative ions. Cs coated tungsten dust of average diameter ~ 2.5 micro-m, is produced in-situ in a Cs coating unit, which is fitted vertically on the plasma chamber. Cs coated dust is allowed to fall into the plasma due to gravity. Negative ion density is estimated using a cylindrical Langmuir probe

and the production of negative hydrogen ion is confirmed by measuring H-alpha, H-beta intensity ratio using optical emission spectroscopic (OES) technique. Dust density is measured by using laser scattering technique. To measure the Cs vapor density in the coating unit, a surface ionization detector (SID) is used. From the recent experimental observation, the negative ion density is estimated as of the order of $10^{15}/\text{m}^3$ for the plasma density of $10^{16}/\text{m}^3$. It is found that the optimum pressure for negative ion production in our set up is 8×10^{-4} mbar. From the recent experimental results, it is found that Cs coated W dust can be used to generate negative ions through surface production route. By optimizing this novel ion source being developed by us, a new type of efficient negative ion source can be designed.

Experiment with new magnetic cage : To improve the plasma confinement, a new samarium cobalt cusps magnetic cage of surface field strength 3.5 kG with necessary water circulation facility through the surface of the magnetic channels was fabricated and installed successfully. The plasma density is of the order of $10^{18}/\text{m}^3$ is found with the new magnetic cage. Arrangement for IAW experiment: The necessary arrangement for IAW experiment to calculate the negative ion density is going on. A high power amplifier (1000 watt) and function generator with burst mode are procured to launch the wave.

B.3.3 Thermal Plasma Processed Materials Laboratory

Development of a Segmented Plasma Torch Assisted Tailored Heat Source : The central component of this system is a segmented plasma arc source, which typically operates at high pressure and hence is capable of producing extreme particle and heat flux density. The plasma torch is connected to a low pressure chamber inside which the plasma jet expands and eventually produces a collimated beam of plasma. In the current phase of this experiment, we have concentrated on maximizing the heat flux carried by the plasma beam by optimizing various experimental variables. After enhancing the input power capability with a new power supply (80 kW, Thyristorized), we have recently demonstrated a maximum heat flux of $8.8 \text{ MW}/\text{m}^2$ (input power 52.5 kW) deposited on a 30 mm diameter substrate kept at a distance of 100 mm from the torch anode. This flux is typical of ITER Divertor region like conditions; hence the system may be used as a platform for performance evaluation of new materials under fusion grade extreme thermal conditions. This system was actually developed with the long term aim of establishing a complete Tokamak Divertor simulator, not only in terms of high heat flux ($1\text{-}10 \text{ MW}/\text{m}^2$), but reproducing Tokamak like hydrogen plasmas with typical electron temperature ($1\text{-}5 \text{ eV}$), ion density (10^{20} m^{-3}) and ion flux ($10^{24} \text{ m}^{-2}\text{s}^{-1}$). Initial experi-

ments show that the beam gets diffused on addition of hydrogen to the plasma argon. Following the Pilot PSI (Dutch Institute for Fundamental Energy Research, Rijnhuizen) design we are going to introduce an axial magnetic field to confine the hydrogen plasma into a collimated power beam. This system may be later used to study interesting plasma surface interaction processes relevant under ITER like conditions. We are also planning to use the system for synthesis of nanomaterials and to further explore the effects of controlled residence time under the magnetic field and extremely low pressure in the particle growth region.

Studies on Thermal Plasma Assisted Synthesis of Nanostructured Materials : One of the key issues in the emerging field of nanotechnology is to develop bulk synthesis methods for nanostructured materials. Over the last decade, the thermal plasmas have emerged as a promising processing medium in this regard. A very good crystallization of the synthesized material because of the presence of very high temperature may be termed as another acute advantage of plasma mediated methods. Unlike the wet chemical methods,

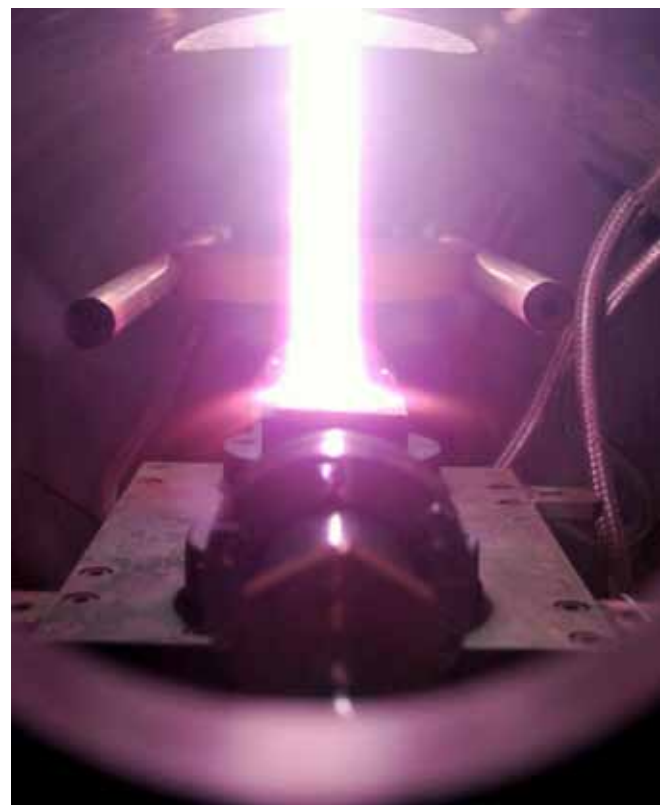

Figure 3.2.1: Photograph shows a collimated beam of argon plasma produced with a segmented arc source propagating inside a low pressure chamber.

this helps in avoiding further heat treatment of the materials, which is notorious for changing particle size distribution and phase composition. This laboratory is involved in developing thermal plasma assisted processes for synthesis of some novel nano-structured materials, and study the physics and chemistry issues involved for their ultimate optimization. Over the last few years, a specific thermal plasma assisted reactor configuration was developed, where a plasma beam seeded with the reactants expands supersonically into a low pressure sample collection chamber, out of which fine particles nucleate by homogenous condensation. The supersonic nozzle in this system allows reduction of pressure in the sample collection chamber without disrupting the plasma discharge. We had explored the effect of reducing pressure to the few-mbar level with a roots (8500 lpm)-rotary (1500 lpm) vacuum pump combination. Average sizes for alumina and titania nanoparticles synthesized by this system for this pressure range were measured to be less than 10 nanometers, which is one of the lowest reported values for these materials by a plasma assisted method^{2, 3}. Particles had fine crystallinity and an impressive very narrow size distribution. Some other recent important results include synthesis of nano carbon particles to be used as catalyst/catalyst support in PEM fuel cells and carbon encapsulated iron nanoparticles for biomedical and other uses. Carbon particles synthesized at around 10 mbar pressure was measured to have BET specific surface area in the range of 340-360 m²/g (nitrogen absorption, Micromeritics, ASAP 2010, CSMRI, Bhavnagar) which is very impressive in terms of other contemporary plasma assisted experimental results. It was observed that the average numbers of nanocarbon sheets stacked together into a single layer inside carbon nanostructures decreases with decreasing pressure in the sample collection pressure. This explains higher specific surface area of the low pressure synthesized carbon particles. These low pressure samples had good crystallinity as well, which is a direct consequence of longer residence time in the expanded plasma jet compared to other conventional plasma assisted processes. Their hydrogen absorption was measured with a Quartz Crystal Microbalance (SQM-160, Department of Physics, Pontificia Universidad Catolica de Chile, Santiago, Chile) to be 0.1 (H/C atomic ratio), at low pressure/temperature conditions.

B.3.4 Pulsed Power Technology Laboratory

Ion irradiation on tungsten : During the period, the following activities were carried out: (i) studied the surface morphology of neon ion exposed and unexposed specimen by employing AFM, (ii) investigated the composition of neon

ion exposed specimen by EDX, (iii) studied the structural analyses of neon ion exposed and unexposed specimen by GIXRD and (iv) measured the surface hardness of neon ion exposed specimens. Results of those studies are summarized very briefly hereafter. AFM micrographs clearly depict distinct differences on the surface morphology while comparing neon ion exposed and unexposed specimens. Microcracks, induced due to the bombardment of neon ions, are observed at lower magnification. The bubbles/ blisters are also appeared in the exposed specimens which occur probably because of the trapping of neon ions. Moreover, pit holes and craters have been found due to the bombardment of neon ions on specimens. The EDX spectrum of neon ion exposed specimen primarily shows many W peaks along with small peaks of Fe and Cr which are appeared due to the presence of the traces of electrode material (SS in our case). However, the spectrum does not show any evidence of neon ion. The GIXRD pattern reveals the appearance of new planes due to neon ion irradiation on the specimen. A small shifting in the major peak towards the higher angular side is marked in case of the ion exposed specimen with respect to the unexposed. The reason behind this shifting is as a result of the compressive stress developed in the specimen due to ion irradiation. A slight reduction in hardness values is observed in case of the exposed specimen than the unexposed. This is because of the formation of micro-cracks, holes/pores and other defects on exposed specimen which appeared due to thermal load delivered by neo ions. Moreover, oxide formation at the surface might have reduced the hardness value a bit.

Fabrication and testing of a tri-dimensional miniature Magnetic probe : A tri-dimensional Magnetic probe (MP) was constructed, which consist of three coils, directed towards axial, radial and azimuthal direction to know axial, radial acceleration and broadening of current sheath of plasma focus device. The probe consists of 4 copper coils wounded on a 4 X 4mm rubber cube. It was carefully shielded from any electromagnetic pickup by inserting it in a copper tube. The whole assembly was then enclosed in a glass tube of diameter of 2mm for electrical insulation. The probe was tested successfully and signals were recorded in a four-channel oscilloscope.

Multiple pinhole camera pictures of X-ray emitting zone of Plasma focus device : A X-ray pinhole camera that capable of capturing three images simultaneously of the same object was assembled and employed to capture images of plasma focus device. The dimensional structures of the three images of the plasma focus device, captured by the camera with the

filters of same thickness (2 micro-m Aluminium) in front of each pinhole were observed to be identical, which indicates that the each pinhole views almost the same region of the plasma column. From the images, one can differentiate the pinch column into three X-ray emitting zones namely: The anode edge region (emits much higher energy X-ray photons), the central core region (emits relatively lower energy X-rays with respect to anode edge) and the diffused peripheral region surrounding the central core region (emits much weaker energy of X-ray photons). It was also observed that the oval and divergent anode shape is more favorable for instabilities and hotspots formation than cylindrical and conical one.

Measurement of effective hard X-ray energy in plasma focus device : Radiograph of Al foil of thickness (0.4, 0.8, 1.2, 1.6 and 2.0 mm) were taken. The gray levels for each radiograph was scanned by MATLAB program, which indirectly gives the intensity of x-ray incident on the film. By calculating ratio of the intensity gray levels measurements of different thickness Al and plotting as a function of thickness, the linear attenuation coefficient of Al foil was estimated for each anode shape, which corresponds to X-ray energy. The estimated hard X-ray energies are 105, 121, 85 and 77 keV for cylindrical, converging, diverging and oval anode shape respectively.

Study of neutron emission from deuterium gas filled plasma focus device : The neutron emission from deuterium gas filled plasma focus device was studied by employing PMT and bubble dosimeter. The time resolved study of neutron emission by PMT found that the energy of the neutron in radial and axial direction is 2.08 MeV and 3.24 MeV respectively. The maximum counts of bubble in the dosimeter are found to be around 10 in axial direction, which is equivalent to 3×10^7 n/shot.

B.3.5 Double Plasma Device Laboratory

Experiment on the effect of variation of transverse magnetic field (TMF) strength on plasma parameters : The experiment is performed in a double plasma device separated by a transverse magnetic filter field at the center. Two stainless steel channels N and S are kept 15 cm apart and three different magnetic field strengths ~ 500 G, ~ 1450 G and ~ 4300 G produces the TMF. Five filaments of 3 cm length each in the source produce plasma at a working pressure of 5×10^{-4} mbar. The discharge voltage and discharge current I_d are varied between 60 V to 100 V and 0.5 A to 2 A respectively. In the source region, for 60 V, 80 V and 100 V discharge voltages,

ne increases from 0.5 KGauss to 1.45 KGauss and then it remains almost constant from 1.45 kG to 4.3 kG. This has been observed for 0.5 A - 2 A discharge current. For a fixed discharge voltage, T_e does not have significant variation with the transverse magnetic field strength. In the target region, ne increases with decreasing magnetic field strength. This has been observed for 0.5, 1, 1.5 and 2 A discharge current as well as for 60 V, 80 V and 100 V discharge voltage. T_e initially decreases from 0.5 kG to 1.45 kG (it varies from 0.5 to 0.2 eV) with the magnetic field (B) and after that it saturates from 1.45 kG to 4.3 kG. This has been observed for 60 V to 100 V discharge voltage as well as for 0.5 A to 2 A discharge current.

Experiment on the influence of secondary electron emission on plasma parameters : The experiment is performed in a double plasma device consisting of a source magnetic cage and a target magnetic cage separated by a transverse magnetic field (TMF) at the center. The magnetic field strength at the center (7.5 cm distance) of the TMF separation is 81 Gauss. Five filaments of 3 cm length each are used in the source magnetic cage to thermionically emit primary electrons for producing plasma by the hot cathode discharge method. In addition, a secondary filament source of length 5 cm is placed in the target chamber. Its emission current is varied from 0.5 A to 2.5 A and a biasing voltage is applied between it and the chamber wall. A rotary and diffusion pump evacuates the plasma chamber to a base pressure of $\sim 4 \times 10^{-6}$ mbar. Hydrogen gas is fed and the working pressure is fixed at 5×10^{-4} mbar. The discharge voltage is kept at 80 V and the discharge current is varied from 0.5 A to 2 A in steps of 0.5 A. Plasma density (n_e) and electron temperature (T_e) are found to be slightly influenced by the emission from the secondary electron emission source, within the discharge current, discharge voltage and secondary electron emission current ranges considered for this experiment. Further studies are underway by selecting other secondary emission current ranges.

Formulation of a theoretical model to explain the influence of plasma loss area on transport of charged particles through a transverse magnetic field : Plasma transport in a double plasma device (DPD) from source region to the target region through a physical window comprising of electrically grounded magnet channels (filled with permanent magnet bars) for transverse magnetic field (TMF) and a pair of stainless steel (SS) plates, are studied. The study has relevance in negative ion source research and development where both TMF created by magnet channels and bias plate (BP) are used. The experiment is performed in two stages. In the first stage, a transverse magnetic field (TMF) is introduced between the two regions along with the SS plates and cor-

responding plasma parameter data in the two regions are recorded by changing the distance between the TMF channels. In the second stage, the TMF is withdrawn from the system and corresponding data are taken by changing the separation between the SS plates. Profiles of plasma density ratios (for the ss case) and differences (for the TMF case) are analyzed by using an one-dimensional theoretical model (1D) to understand the plasma transport across the TMF field and the effect of electrically grounded structure near TMF region on it. Using appropriate equations for the cross-field diffusion coefficient and magnetic field profile, relations are derived for plasma flux from the source region to the target region both for the TMF case and ss case. The experimental plots are validated by the plots obtained from the theoretically derived relations. It has been found that there is good agreement between the theoretical and experimental curves.

Purchase and installation of laboratory items : Purchase orders for magnets, bellows, rotary pump and accessories, vacuum component and accessories, fabrication of magnetic cages, fabrication of cesium oven and flanges were placed and all the items have been received. Installation, vacuum testing and experimentation using the newly fabricated items are underway.

B.3.6. Cross-Disciplinary Plasma Science Laboratory

In last year we took up the following work on plasma processing. (i) TiN (Titanium nitride) coating on plasma nitrided high speed steel(HSS). (ii) AlN (Aluminium nitride) coating on plasma nitrided high speed steel(HSS). This work was first initiated at CDPS laboratory in CPP-IPR and later on a part of the work was done in FCIPT, IPR Gandhinagar. Result shows that the hardness of high speed steel was increased upto 3 times (from base hardness 250 HV to 750HV) during plasma nitriding for 24 hours at a composition of 20% nitrogen and 80% hydrogen. TiN coating was deposited on pre nitrided HSS at a pressure of 3 mbar varying nitrogen flow rate from 2 to 5 mlit/min. Also the temperature of the substrate was kept at 200C and a substrate biasing voltage of 50V was applied during deposition. XRD pattern of plasma nitrided substrate and TiN coated on plasma nitrided substrate was shown in Figure B.1.2.2 (page no 39) and hardness profile of the same two substrate is shown in Figure B.3.6.2. AlN coating was deposited on pre nitrided HSS at a pressure of 3 mbar varying nitrogen flow rate from 2 to 5 mlit/min. Also the temperature of the substrate was kept at 200oC and a substrate biasing voltage of 50V was applied during deposition

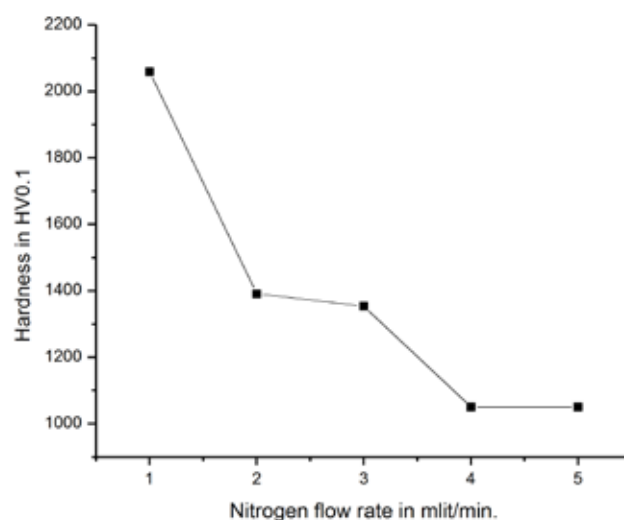

Figure B.3.6.2: Hardness Vs N flow rate

at a power of 450W. We have also took up the surface modification of polymers for use in biomedical application in CDPS laboratory in last year. In our lab a few polymeric hydrogel substrates are being treated with suitable plasmagen gas to study the effects of surface treatment. An increase in hydrophilicity and surface roughness are expected from the plasma treatment. Polymers being sensitive to high temperatures, they are generally surface treated with atmospheric plasma. In our lab we modified the magnetron sputtering target by using a grid with the polymer target to see whether the desired surface modification could be achieved. The SEM showed visible signs of etching in the morphology of the commercial polymer treated with Ar sputtering. In the next step we have synthesized some polymer hydrogels which have known biomedical applications and toughened by a benign chemical cross linking process so that they remain non-toxic and suitable for biomedical applications. These samples will be treated in both our magnetron sputtering plasma and Atmospheric plasma to compare the relative differences in surface properties such as etching pattern, (from SEM), hydrophilicity (by contact angle measurement) .

B.4. Board of Research in Fusion Science and Technology (BRFST)

During the period, in the reviews held in August 2011 and March 2012, the total committed budget for R&D projects was Rs. 717.47 Lakhs. 28 new projects were awarded during this period. Till March 2012, BRFST has awarded 88 R&D projects with a total commitment of ~ Rs. 2,505 Lakhs of

which 19 were awarded to industries with a total commitment of Rs. 535 Lakhs. Sixty nine projects were awarded to academic institutions with a total commitment of Rs. 1970.33 lakhs. Forty One conferences in various areas of fusion science & technology were supported by BRFST in this period with a total commitment of ~ Rs. 55.6 Lakhs. The total outflow of funds during the period February 2011 and March 2012 was Rs.986.75 Lakhs. The summary of the total R&D projects granted under NFP during the period August 2007 to March 2012 is given in the table. BRFST also held several contact meetings for the faculty from NIT's IIT's and other academic institutions as well as for selected industry members in order to promote R&D in the areas of Fusion science & Technology. Incentive scheme providing travel assistance to project staff to attend conferences abroad was also introduced by BRFST in this period. BRFST proposes to organize a biennial conference to showcase the output from the R&D projects funded under the National Fusion Programme

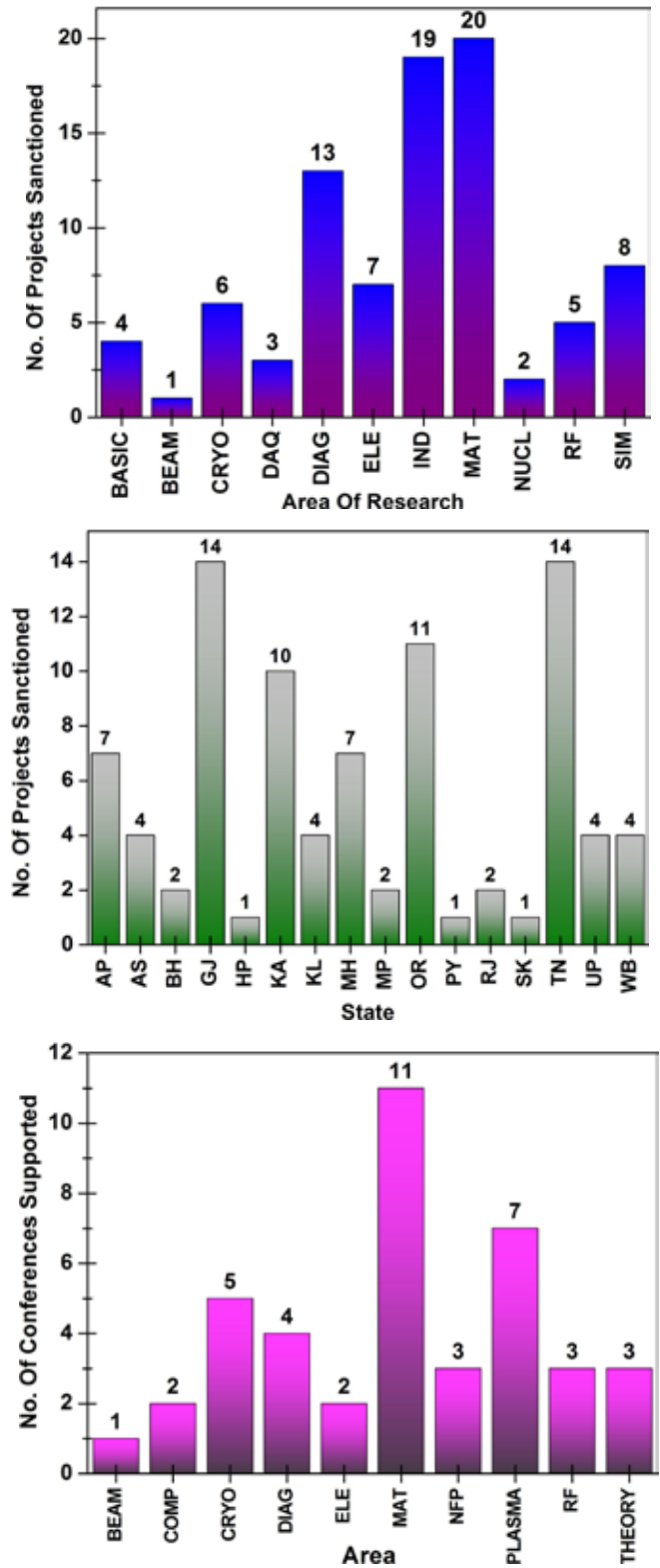
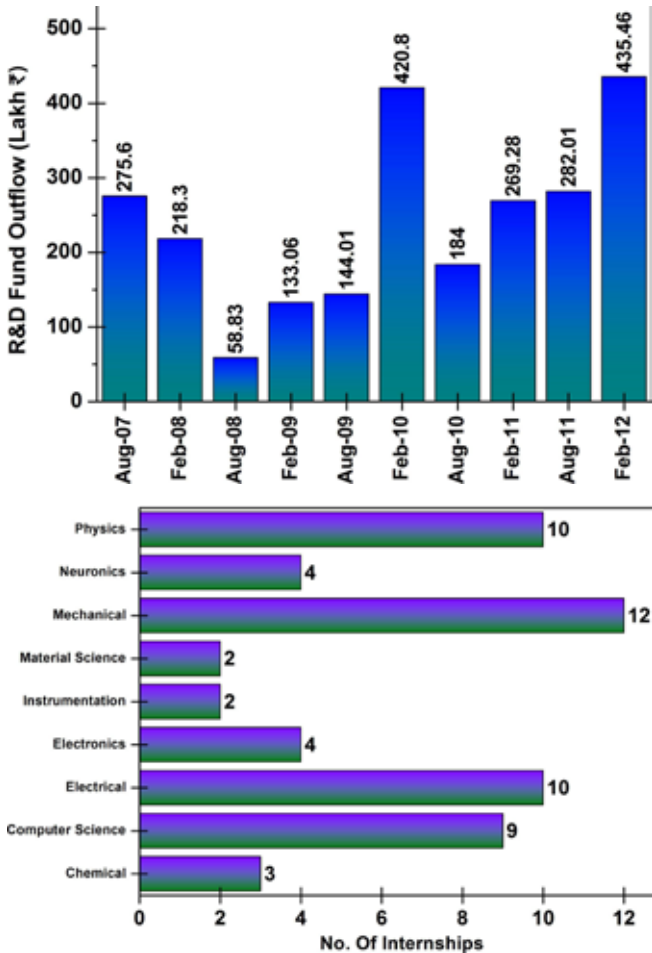

C. ACADEMIC PROGRAMMES

C.1 DOCTORATE PROGRAMME

In the Ph.D. programme conducted by the institute twenty nine (29) research scholars have been enrolled at present. Out of them, ten (10) are working in theoretical and simulation projects while seven (7) are engaged in experimental projects. Twelve (12) new student has joined this programme during the year and is going through the course work. After successful completion of this course work, they will be enrolled for their Ph.D. works.

Ph.D. THESIS SUBMITTED (during April 2011 - March 2012)

Experimental Studies on Atmospheric Pressure Glow Discharge Plasma

Anand Kumar Srivastava

Devi Ahilya Vishwavidyalaya, Indore, 2011

Molecular Dynamics Simulations of Coherent Structures in Strongly Coupled Yukawa Liquids

Ashwin Joy

Homi Bhabha National Institute, 2011

Plasma Response to Transient High Voltage Pulses

Satyananda Kar

Homi Bhabha National Institute, 2011

Linear and Nonlinear Global Gyrokinetic Study of Microinstabilities in Tokamaks

Jugal Chowdhury

Homi Bhabha National Institute, 2011

C.2 SUMMER SCHOOL PROGRAMME

Sixty-one (61) students participated in this programme, which aimed at providing an opportunity to (29) students from M.Sc. Physics and (32) students from Engineering discipline which include Mechanical, Electronics and instrumentation, Electrical, Chemical and Metallurgy, to interact actively with scientists of the institute and learn about Plasma Physics and related areas through a project and series of lectures. Besides the above-mentioned training programme, project works are routinely offered in Computer, Electronics and Electrical Engineering for regular students as a part of their academic requirements.

--!!!--

D. TECHNICAL SERVICES

D.1. Engineering Services

D.1.1. Air conditioning (AC) and Water cooling (WC)

During the report period we have carried out activities like Up-gradation and revamping of SST1 WCS SCADA system with latest Network Automation Engine and Application Data Server Software. This system enables Internet Protocol connectivity and web-based access to SCADA system. It can support long-term historical data storage with backend database and with export utility extractor function it can extract historical trend, alarm and audit data from the system and presents the historical data in a variety of formats like Microsoft Excel and Access. Process cooling side we have designed sub header piping for different systems like MFM-LPD, Dusty plasma, flowing system and source flange and commissioning is already started in Basic experimental lab at IPR. These sub headers are connected to main process cooling piping headers. Also, designing and tender floating of Water Cooling Loop1 extension for ICH & RD Lab. and DST Gyrotron system is completed.

In the Air-conditioning fronts, we have done erection, testing and commissioning of 10 nos. air cooled condenser units for existing 5 nos. 10 TR (5 TR X Twin circuit) package type air conditioning system in computer centre. Design and tender floating of Air washer system (18000 CFM) with Ducting work for workshop area at IPR. Ducting & Piping work in different Labs of ITER India, Chilled water pumps & AHU installations, Electrical Panel & cabling work is completed. Chiller installation & BMS system installation is to be carried out in near term. Installation, testing and commissioning of Fire-fighting system at ITER India building at IPR. We have also carried out maintenance activities for SST1 WCS system like servicing of electrical panel, chilled and condenser water pumps, re-generation of DM plants etc.

D.1.2. Computer Services

Highlights of work done by the computer division in augmenting and strengthening the IT infrastructure of the institute :

Application Software development & implementation

- * Cafeteria software at IPR, ITER and FCIPT campuses
- * Online application system for PhD and Summer school applicants
- * Online paybill viewing software

Infrastructural enhancements

- Webmail with 10 TB SAN storage
- Procurement of routers and fault tolerant system servers for migration of Internet services and IPV6 readiness
- New Hitachi projector Installations and whiteboards at various meeting rooms and academic halls
- Upgradation of Internet link from 8 Mbps to 40 Mbps
- Replacement of old PCs with new systems and overseeing their installation and data migration
- Procurement and distribution of peripherals
- Procurement and installation support for softwares like ANSYS, CATIA
- Network monitoring and troubleshooting through network management software
- Security auditing
- Videoconferencing support for interviews, conferences
- Fibre connectivity at remote locations in the campus
- Testing of UTM device
- Technical support to SAP vendor
- Live webcast of IPR Annual night

D.2. Library Services

IPR library has created information rich environment and now it has become knowledge hub in the field of Plasma physics and allied subjects and gives opportunities to Plasma Physicists for life long learning. It doesn't provide only printed literature or e-resources but it also pass on the information literacy skills to its users by value added services.

Library subscribes major databases such as SCOPUS, SCIENCE DIRECT, IOP Archives, Archives of Journal of Plasma Physics, APS Journals and PROLA. This year total 14 new online journals added to the e-collection including Nature, Nature Physics and Scientific American. All these e-resources are accessible to all the users' at all divisional libraries.

About 631 books, 44 internal research reports, 32 technical reports, 111 new research reports, 8 standards, 130 reprints

and 65 software's were added in to the library collection and subscribed to 105 periodicals. Procured 6 DVD's set of inventor's specials. Total 6 E-books and 3 thesis added to the collection.

82.78 % of the requests made by IPRites were satisfied through ILL service. IPR Library provided documents to other institutes against ILL queries & 92.30% of the total need were satisfied. Total 92000 photocopies supplied to users. Improved website of library and also added alert service through website for users. Continued to provide current content services, very widely to plasma physicists at national level. Total 26 News items were displayed as an Alert Service in the field of Plasma Physics and Fusion Technology. During reporting period total of Rs. 1,49,39,515.00 budget was utilized. IPR Library helped in RTI activities and OLIC programmes.

All library staff actively participated in professional meetings and institutional activities. Also trained three library trainees and divisional library staff especially CPP-IPR by providing all technical support.

--!!!--

E. PUBLICATION AND PRESENTATION

E.1 RESEARCH REPORTS (Published in Scientific Journals and Proceedings)

Thickness-dependent Fcc–Hcp Phase Transformation in Polycrystalline Titanium Thin Films

J. CHAKRABORTY, KISHOR KUMAR, RAJEEV RANJAN, S. GHOSH CHOWDHURY, S.R. SINGH
Acta Materialia, 59, 2615-2623, 2011

Introduction to Neoclassical Tearing Modes and the Role of Rotation

ABHIJIT SEN

Fusion Science and Technology, 59, 526-538, 2011

Coherent Vortices in Strongly Coupled Liquids

ASHWIN J. and R. GANESH

Physical Review Letters, 106, 135001, 2011

Role of Fluctuations and Flows in Sustaining Mean Profiles in a Current Less Toroidal Plasma

T. S. GOUD, R. GANESH, Y. C. SAXENA, D. RAJU, K. SATHYANARAYANA, K. K. MOHANDAS, and C. CHAVDA

Physics of Plasmas, 18, 042310, 2011

Relativistic Effects on Nonlinear Lower Hybrid Oscillations in Cold Plasma

CHANDAN MAITY, NIKHIL CHAKRABARTI, and SUDIP SENGUPTA

Journal of Mathematical Physics, 52, 043101, 2011

A Sniffer Technique for an Efficient Deduction of Model Dynamical Equations using Genetic Programming

D.P. AHALPARA, A. SEN

Lecture Notes in Computer Science, 6621, 1-12, 2011

14th European Conference on Genetic Programming, EuroGP 2011, Torino, Italy, 27-29 April 2011

Experimental Investigation of Oscillatory Structures in Laser-Blow-Off Plasma Plume

RAJNEESH KUMAR, AJAI KUMAR, R.K. SINGH and JINTO THOMAS

Physics Letters A, 375, 2064-2070, 2011

On the Ground and Excited State Dipole Moments of Dansylamide from Solvatochromic Shifts of Absorption and Fluorescence Spectra

N. TEWARI, N.K. JOSHI, R. RAUTELA, R. GAHLAUT, H.C. JOSHI and S. PANT
Journal of Molecular Liquids, 160, 150-153, 2011

Resonance Hairpin and Langmuir Probe-Assisted Laser Photodetachment Measurements of the Negative Ion Density in a Pulsed Dc Magnetron Discharge

JAMES W. BRADLEY, ROBERT DODD, S.-D. YOU, NISHANT SIRSE, and SHANTANU KUMAR KARKARI

Journal of Vacuum Science & Technology A, 29, 031305, 2011

Experimental Study of Electromagnetic Band Gaps using Plasmas or Defaults in a Metallic Photonic Crystal

RAJNEESH KUMAR

Microwave and Optical Technology Letters, 53, 1109–1113, 2011

Effects of Harmonic Overlap and Polarization Scrambling on Electron Cyclotron Emission from ITER Plasma

S. DANANI, HITESH KUMAR B. PANDYA, P. VASU, M. E. AUSTIN

Fusion Science and Technology, 59, 651-656, 2011

Progress in the Development of the ITER ECE Diagnostic

V. S. UDINTSEV, G. VAYAKIS, A. E. COSTLEY, K. M. PATEL, C. S. PITCHER, C. I. WALKER, M. J. WALSH, M. BENCHIKHOUNE, D. BORA, A. DAMMANN, M. A. HENDERSON, B. LEVESY, A. TESINI, S. DANANI, H. PANDYA, P. VASU, M. E. AUSTIN, P. E. PHILLIPS, W. L. ROWAN, R. FEDER, D. JOHNSON

Fusion Science and Technology, 59, 678-683, 2011

Excitation of Ion Rarefaction Waves in a Low Pressure Plasma by Applying a Short High Negative Voltage Pulse

S. KAR, S. MUKHERJEE, and Y. C. SAXENA

Physics of Plasmas, 18, 053506, 2011

Strain Measurement on Superconductor Joints using an External Bridge Completion Technique

YOHAN KHRISTI, KALPESH DOSHI, SUNIL KEDIA and SUBRATA PRADHAN

Measurement Science and Technology, 22, 065102, 2011

Ordered Ag Nanocluster Structures by Vapor Deposition on Pre-patterned SiO₂

SATOSHI NUMAZAWA, MUKESH RANJAN, KARLHEINZ HEINIG, STEFAN FACSKO and ROGER SMITH

Journal of Physics: Condensed Matter, 23, 222203, 2011

Image Analysis of Expanding Laser-Produced Lithium Plasma Plume in Variable Transverse Magnetic Field

AJAI KUMAR, SONY GEORGE, R.K. SINGH, HEM JOSHI and V.P.N. NAMPOORI
Laser and Particle Beams, 29, 241-247, 2011



Study on Plasma Parameters and Dust Charging in an Electrostatically Plugged Multicusp Plasma Device

B. KAKATI, S. S. KAUSIK, B. K. SAIKIA, and M. BANDYOPADHYAY

Physics of Plasmas, 18, 063704, 2011

Effect of Transverse Magnetic Field on the Laser-Blow-Off Plasma Plume Emission in the Presence of Ambient Gas

A. KUMAR, R.K.SINGH, H. JOSHI

Spectrochimica Acta - Part B Atomic Spectroscopy, 66, 444-450, 2011

A Simple Coaxial Ceramic Based Vacuum Window for Vacuum Transmission Line of ICRF System

D. RATHI, K. MISHRA, S. GOERGE, A. VARIA, S. V. KULKARNI, and ICRH TEAM

AIP Conference Proceedings of the 19th Topical Conference on Radio Frequency Power in Plasmas, Newport, 1406, 109-112, 2011

Direct Electron Heating Observed by Fast Waves in ICRF Range on a Low-Density Low Temperature Tokamak ADITYA

K. MISHRA, S. KULKARNI, D. RATHI, A. VARIA, H. JADAV, K. PARMAR, B. KADIA, R. JOSHI, Y. SRINIVAS, R. SINGH, S. KUMAR, S. DANI, A. GAYATRI, R. YOGI, M. SINGH, Y. JOISA, C. RAO, S. KUMAR, R. JHA, R. MANCHANDA, J. GHOSH, P. ATREY, S. BHATT, C. GUPTA, P. CHATTOPADHYAYA, A. CHATTOPADHYAYA, R. SRINIVASAN, D. BORA, P. KAW, and ADITYA TEAM

AIP Conference Proceedings of the 19th Topical Conference on Radio Frequency Power in Plasmas, Newport, 1406, pp. 257-260, 2011

Long Pulse Operation with the ITER-Relevant LHCD Antenna in Tore Supra

A. EKEDAHL, L. DELPECH, M. GONICHE, D. GUILHEM, J. HILLAIRET, M. PREYNAS, P. K. SHARMA, J. ACHARD, Y. S. BAE, X. BAI, C. BALORIN, Y. BARANOV, V. BASIUK, A. BECOULET, J. BELO, G. BERGER-BY, S. BREMOND, C. CASTALDO, S. CECCUZZI, R. CESARIO, E. CORBEL, X. COURTOIS, J. DECKER, E. DELMAS, B. J. DING, X. DING, D. DOUAI, R. DUMONT, C. GOLETTA, J. P. GUNN, P. HERTOUT, G. T. HOANG, F. IMBEAUX, K. KIROV, X. LITAUDON, P. LOTTE, P. MAGET, R. MAGNE, J. MAILLOUX, D. MAZON, F. MIRIZZI, P. MOLLARD, P. MOREAU, T. OOSAKO, V. PETRZILKA, Y. PEYSSON, S. POLI, M. PROU, F. SAINT-LAURENT, F. SAMAILLE

AIP Conference Proceedings of the 19th Topical Conference on Radio Frequency Power in Plasmas, Newport, 1406, pp. 399-406, 2011

Lower Hybrid Current Drive Efficiency at High Density on Tore Supra

M. GONICHE, P. K. SHARMA, V. BASIUK, Y. BARANOV, C. CASTALDO, R. CESARIO, J. DECKER, L. DELPECH, A. EKEDAHL, J. HILLAIRET, K. KIROV, D. MAZON, T. OOSAKO, Y. PEYSSON, and M. PROU

AIP Conference Proceedings of the 19th Topical Conference on Radio Frequency Power in Plasmas, Newport, 1406, pp. 407-410, 2011

Bremsstrahlung Emission Modelling and Application to Fast Electron Physics

J. DECKER, Y. PEYSSON, J. F. ARTAUD, V. BASIUK, S. CODA, A. EKEDAHL, S. GNESIN, M. GONICHE, D. MAZON and P. SHARMA

AIP Conference Proceedings of the 19th Topical Conference on Radio Frequency Power in Plasmas, Newport, 1406, p. 447-450, 2011

42GHz 0.5MW ECRH system for Tokamaks SST-1 and Aditya

B.K.SHUKLA, R.GOSWAMI, R. BABU, J.PATEL, P.K.CHATTOPADHYAY, R.SRINIVASAN, H.PATEL, P.DHORAJIA

IEEE/NPSS 24th Symposium on Fusion Engineering (SOFE), Chicago, 6052321, 26-30 2011

SST-1 Status & Plans

S. PRADHAN, A.N.SHARMA, V.L.TANNA, Z.KHAN, U.PRASAD, D.C.RAVAL, F.KHAN, N.C.GUPTA, J.TANK, M.K.GUPTA, P.SANTRA, P.BISWAS, H.MASAND, D.SHARMA, A.SRIVASTAVA, H.PATEL

IEEE/NPSS 24th Symposium on Fusion Engineering (SOFE), Chicago, 6052353, 26-30 2011

Development of CuCrZr Alloy for Applications in Neutral Beams

C. ROTTI, A.K.CHAKRABORTY, I. AHMED, G.ROOPESH, M.BANDYOPADHYAY, M.J.SINGH, SEJAL SHAH, A.PHUKAN, R.K.YADAV, N. PANDA, K. BALASUBRAMANIAN

IEEE/NPSS 24th Symposium on Fusion Engineering (SOFE), Chicago, 6052213, 26-30, 2011

High power test of CVD diamond window for ECRH system in SST-1

B.K.SHUKLA, R. BABU, M. KUSHWAH, K. SATHYANARAYANA, J. PATEL, S.L. RAO, D. PRAGNESH, H. PATEL, S. BELSARE, R. VIPAL, S.D. PATEL, B. VISHAL, A.S. PRIYANKA, S. ANJALI, S. RONAK, M. SHMELEV, Y. BELOV, V. BELOUSOV

IEEE/NPSS 24th Symposium on Fusion Engineering (SOFE), Chicago, 6052320, 26-30, 2011

- A Plasma Source for High Power Microwave Interaction Studies
V.P. ANITHA, PRIYAVANDNA J. RATHOD, RENU BAHL, JAYESH RAVAL, Y.C. SAXENA, ANURAG SHYAM, AMITA DAS AND P.K. KAW
IEEE/NPSS 24th Symposium on Fusion Engineering (SOFE), Chicago, 5993096, 26-30, 2011
- Study of EMHD Waves in a Magnetic Bubble
V.P. ANITHA, S.P. BANERJEE, D. SHARMA AND S.K. MATTOO
IEEE/NPSS 24th Symposium on Fusion Engineering (SOFE), Chicago, 5993051, 26-30, 2011
- Design, development, testing and operation of Regulated High Voltage power Supplies (RHVPS) utilized by NBI and RF heating systems for SSTI
P. J. PATEL, C. B. SUMOD, D. P. THAKKAR, L.N. GUPTA, V. B. PATEL, L. K. BANSAL, K. QURESHI, V. VADHER, N. P. SINGH, U.K. BARUAH
IEEE/NPSS 24th Symposium on Fusion Engineering (SOFE), Chicago, 6052332, 26-30, 2011
- General and Crevice Corrosion Study of the Materials for ITER Vacuum Vessel In-Wall Shield
H.A. PATHAK, R.K. DAYAL, V.K. BAFNA, I. KIMIHIRO, V. BARABASH
IEEE/NPSS 24th Symposium on Fusion Engineering (SOFE), Chicago, 6052259, 26-30, 2011
- Development of & Integration of the IC H&CD System Configuration in the ITER Tokamak Complex and Auxiliary Buildings
D. RATHI, B. BEAUMONT, B. ARAMBHADIYA, B. BECKETT, B. BRUYERE, T. GASSMANN, F. KAZARIAN, P. LAMALLE, E. MANON, T. ALONZO, U. BARUAH, R. KUMAR, A. MUKHERJEE, N.P. SINGH, R. SINGH, R. TRIVEDI, R. GOULDING, R. MOON, D. RASMUSSEN, D. SWAIN, G. AGARICI, L. MEUNIER, M. MILLS, R. SARTORI, J.-M. BERNARD, F. DURODIE, M. NIGHTINGALE, M. SHANNON, D. LOCKLEY, and ITER ORGANIZATION
IEEE/NPSS 24th Symposium on Fusion Engineering (SOFE), Chicago, 6052322, 26-30 2011
- Multi-secondary Transformer: A Modeling Technique for Simulation
A. PATEL, N.P. SINGH, B. RAVAL, A. ROY, A. THAKAR, D. PARMAR, H. DHOLA, R. DAVE, S. GAJJAR, V. GUPTA, U. BARUAH, V. TRIPATHI, L. N. GUPTA, and P. PATEL
IEEE/NPSS 24th Symposium on Fusion Engineering (SOFE), Chicago, 6052231, 26-30 2011
- Two RF Driver Based Negative Ion Source for Fusion R&D
M.BANDYOPADHYAY, M.J.SINGH, G.BANSAL, A.GAHLAUT, K.PANDYA, K.G.PARMAR, J.SONI, IRFAN AHMED, G.ROOPESH, C.ROTTI, S.SHAH, A.PHUKAN, R.K.YADAV and A. K. CHAKRABORTY
IEEE/NPSS 24th Symposium on Fusion Engineering (SOFE), Chicago, 6052313, 26-30 2011
- Study of Structure Development of Titanium Nitride on Inclined Substrates
K. KISHOR KUMAR, P.M. RAOLE, P.A. RAYJADA, N.L. CHAUHAN, S. MUKHERJEE
Surface and Coatings Technology, 205, S187-S191, 2011
- Fluorescence Studies of Some Protonated Cinchona Alkaloids in Polymers
NEERAJ KUMAR JOSHI, RANJANA RAUTELA, HEM CHANDRA JOSHI, and SANJAY PANT
Journal of Luminescence, 131, 1550-1555, 2011
- Phase Mixing/Wave Breaking Studies of Large Amplitude Oscillations in a Cold Homogeneous Unmagnetized Plasma
SUDIP SENGUPTA, PREDHIMAN KAW, VIKRANT SAXENA, ABHIJIT SEN and AMITA DAS
Plasma Physics and Controlled Fusion, 53, 074014, 2011
- Effect of Polarization Force on the Jeans Instability of Self-Gravitating Dusty Plasma
R.P. PRAJAPATI
Physics Letters A, 375, 2624-2628, 2011
- Lowering the Sintering Temperature of MgB₂/Fe Wires with High Transport Current by Nano Cu Doping
NESON VARGHESE, K. VINOD, S. RAHUL, K. M. DEVADAS, SYJU THOMAS, P. M. ASWATHY, S. PRADHAN, and U. SYAMAPRASAD
AIP Conference Proceedings, 1349, 891-892, 2011
- Impact of Bending Strain on Critical Current of Second Generation 344 YBCO High T_c Coated Conductor
ANANYA KUNDU, PIYUSH RAJ, and SUBRATA PRADHAN
AIP Conference Proceedings, 1349, 895-896, 2011
- Influence of Manganese Acetyl Acetonate on the Cure-kinetic Parameters of Cyanate Ester-epoxy Blend Systems in Fusion Relevant Magnets Winding Packs
SUBRATA PRADHAN, PRIYANKA BRAHMBHATT, JANARDHANAN DEVAKI SUDHA, JISHA UNNIKRISHNAN
Journal of Thermal Analysis and Calorimetry, 105, 301-311, 2011



Secondary Instability of Electromagnetic Ion-Temperature-Gradient Modes for Zonal Flow Generation

JOHAN ANDERSON, HANS NORDMAN, RAMESWAR SINGH, and RAGHVENDRA SINGH

Physics of Plasmas, 18, 072306, 2011

Microstructure and Properties of Three Phase Carbon and Ceramic Matrix Composites

LALIT MOHAN MANOCHA, MILAN MAHENDRABHAI VYAS, SATISH MANOCHA, P.M. RAOLE

Key Engineering Materials, 484, 1-8, 2011

On Radial Density Profile of Plasma Blob Injected into a Curved Vacuum Chamber

G. SAHOO, R. PAIKARAY, D.KARAN, N. SASINI, S. SAMANTARAY, D.C. PATRA, J. GHOSH, A.K. SANYASI

International Conference on Multimedia Technology (ICMT), 6465 - 6467, 26-28, 2011

Transport Properties of Sealed MgB₂/Fe/Ni Multifilamentary Wires Heat Treated in Air

K.M. DEVADAS, S. RAHUL, SYJU THOMAS, NESON VARGHESE, K. VINOD, U. SYAMAPRASAD, S. PRADHAN, M.K. CHATTOPADHYAY, S.B. ROY

Journal of Alloys and Compounds, 509, 8038-8041, 2011

Photochemistry of 5-Aminoquinoline in Protic and Aprotic Solvents

JAGAT P. BRIDHKOTI, HIRDYESH MISHRA, H.C. JOSHI, and SANJAY PANT

Spectrochimica Acta Part A: Molecular and Biomolecular Spectroscopy, 79, 412-417, 2011

Generation and Amplification of Magnetic Islands by Drift Interchange Turbulence

M. MURAGLIA, O. AGULLO, S. BENKADDA, M. YAGI, X. GARBET, and A. SEN

Physical Review Letters, 107, 095003, 2011

Burn Phase Calculations and One-Dimensional Optimization Studies for an Inverse Z-Pinch Magnetized Target Fusion System

P V SUBHASH, S MADHAVAN, N SAKTHIVEL, V MISHRA, AADITYA V MAJALEE, P PAHARI and S CHATURVEDI

Plasma Physics and Controlled Fusion, 53, 085013, 2011

Coevolution of Inverse Cascade and Nonlinear Heat Front in Shear Flows of Strongly Coupled Yukawa Liquids

J. ASHWIN and R. GANESH

Physics of Plasmas, 18, 083704, 2011

Stability of Networks of Delay-Coupled Delay Oscillators

J. M. HOFENER, G. C. SETHIA and T. GROSS

Europhysics Letters, 95, 40002, 2011

Measurement of Emission Current and Temperature Profile of Emissive Probe Materials using CO₂ LASER

PAYAL MEHTA, ARUN SARMA, JOYDEEP GHOSH, SHWETANG PANDYA, SANTOSH PANDYA, PARITOSH CHOUDHURI, J. GOVINDARAJAN, C.IONITA SCHRITTWIESER, ROMAN SCHRITTWIESER

Current Applied Physics, 11, 1215-1221, 2011

High Spatial Resolution Equilibrium Reconstruction

Q. REN, M. S. CHU, L. L. LAO and R. SRINIVASAN

Plasma Physics and Controlled Fusion, 53, 095009, 2011

Direct Electron Heating Experiment on the Aditya Tokamak Using Fast Waves in the Ion Cyclotron Resonance Frequency Range

KISHORE MISHRA, S V KULKARNI, D RATHI, ATUL D VARIA, H M JADAV, K M PARMAR, B R KADIA, R JOSHI, Y S S SRINIVAS, RAJ SINGH, SUNIL KUMAR, S DANI, A GAYATRI, R A YOGI, SINGH MANOJ, Y S JOISA, C V S RAO, SAMEER KUMAR, R JHA, R MANCHANDA, J GHOSH, P K ATREY, S B BHATT, C N GUPTA, P K CHATTOPADHYAYA, A K CHATTOPADHYAYA, R SRINIVASAN, DHIRAJ BORA, P K KAW and ADITYA TEAM

Plasma Physics and Controlled Fusion, 53, 095011, 2011

Design and Overview of 100 kV Bushing for the DNB Injector of ITER

SEJAL SHAH, S. RAJESH, S. NISHAD, B. SRUSTI, M. BANDYOPADHYAY, C. ROTTI, M. J. SINGH, G. ROOPESH, A. K. CHAKRABORTY, B. SCHUNKE, R. HEMSWORTH, J. CHAREYRE, L. SVENSSON

AIP Conference Proceedings, 1390, 555-566, 2011

RF - Plasma Source Commissioning in Indian Negative Ion Facility

M.J. SINGH, M. BANDYOPADHYAY, G. BANSAL, A. GEHLAUT, J. SONI, SUNIL KUMAR, K. PANDYA, K.G. PARMAR, J. SONARA, RATNAKAR YADAV, A.K. CHAKRABORTY, W. KRAUS, B. HEINEMANN, R. RIEDL, S. OBERMAYER, C. MARTENS, P. FRANZEN, and U. FANTZ

AIP Conference Proceedings, 1390, 604-613, 2011

Cesium Delivery System for Negative Ion Source at IPR

G. BANSAL, K. PANDYA, M. BANDYOPADHYAY, A. CHAKRABORTY, M. J. SINGH, J. SONI, A. GAHLAUT, AND K. G. PARMAR

AIP Conference Proceedings, 1390, 614-623, 2011

Conceptual Design, Implementation and Commissioning of Data Acquisition and Control System for Negative Ion Source at IPR

JIGNESH SONI, RATNAKAR YADAV, A. GAHLAUT, G. BANSAL, M.J.SINGH, M. BANDYOPADHYAY, K G PARMAR, K. PANDYA, A. CHAKRABORTY
AIP Conference Proceedings, 1390, pp. 624-633, 2011

Contribution of Tore Supra in Preparation of ITER

B. SAOUTIC, J. ABITEBOUL, L. ALLEGRETTI, S. ALLFREY, J.M. ANE, T. ANIEL, A. ARGOUARCH, J.F. ARTAUD, M.H. AUMENIER, S. BALME, V. BASIUK, O. BAULAIGUE, P. BAYETTI, A. BECOULET, M. BECOULET, M.S. BENKADDA, F. BENOIT, G. BERGER-BY, J.M. BERNARD, B. BERTRAND, P. BEYER, A. BIGAND, J. BLUM, D. BOILSON, G. BONHOMME, H. BOTTOLLIER-CURTET, C. BOUCHAND, F. BOUQUEY, C. BOURDELLE, S. BOURMAUD, C. BRAULT, S. BREMOND, C. BROSSET, J. BUCALOSSI, Y. BURAVAND, P. CARA, V. CATHERINE-DUMONT, A. CASATI, M. CHANTANT, M. CHATELIER, G. CHEVET, D. CIAZYNSKI, G. CIRAULO, F. CLAIRET, M. COATANEA-GOUACHET, L. COLAS, L. COMMUN, E. CORBEL, Y. CORRE, X. COURTOIS, R. DACHICOURT, M. DAPENA FEBRER, M. DAVI JOANNY, R. DAVIOT, H. DE ESCH, J. DECKER, P. DECOOL, P. DELAPORTE, E. DELCHAMBRE, E. DELMAS, L. DELPECH, C. DESGRANGES, P. DEVYNCK, T. DITTMAR, L. DOCEUL, D. DOUAI, H. DOUGNAC, J.L. DUCHATEAU, B. DUGUÉ, N. DUMAS, R. DUMONT, A. DUROCHER, F.X. DUTHOIT, A. EKEDAHL, D. ELBEZE, M. EL KHALDI, F. ESCOURBIAC, F. FAISSE, G. FALCHETTO, M. FARGE, J.L. FARJON, M. FAURY, N. FEDORCZAK, C. FENZI-BONIZEC, M. FIRDAOUSS, Y. FRAUEL, X. GARBET, J. GARCIA, J.L. GARDAREIN, L. GARGIULO, P. GARIBALDI, E. GAUTHIER, O. GAYE, A. GÉRAUD, M. GEYNET, P. GHENDRIH, I. GIACALONE, S. GIBERT, C. GIL, G. GIRUZZI, M. GONICHE, V. GRANDGIRARD, C. GRISOLIA, G. GROS, A. GROSMAN, R. GUIGON, D. GUILHEM, B. GUILLERMINET, R. GUIRLET, J. GUNN, O. GURCAN, S. HACQUIN, J.C. HATCHRESSIAN, P. HENNEQUIN, C. HERNANDEZ, P. HERTOUT, S. HEURAUX, J. HILLAIRET, G.T. HOANG, C. HONORE, M. HOURY, T. HUTTER, P. HUYNH, G. HUYSMANS, F. IMBEAUX, E. JOFFRIN, J. JOHNER, L. JOURD'HEUIL, Y.S. KATHARRIA, D. KELLER, S.H. KIM, M. KOCAN, M. KUBIC, B. LACROIX, V. LAMAISSON, G. LATU, Y. LAUSENAZ, C. LAVIRON, F. LEROUX, L. LETELLIER, M. LIPA, X. LITAUDON, T. LOARER, P. LOTTE, S. MADELEINE, P. MAGAUD, P. MAGET, R. MAGNE, L. MANENC, Y. MARANDET, G. MARBACH,

J.L. MARÉCHAL, L. MARFISI, C. MARTIN, G. MARTIN, V. MARTIN, A. MARTINEZ, J.P. MARTINS, R. MASSET, D. MAZON, N. MELLET, L. MERCADIER, A. MERLE, D. MESHCHERIAKOV, O. MEYER, L. MILLION, M. MISSIRLIAN, P. MOLLARD, V. MONCADA, P. MONIER-GARBET, D. MOREAU, P. MOREAU, L. MORINI, M. NANNINI, M. NAIM HABIB, E. NARDON, H. NEHME, C. NGUYEN, S. NICOLLET, R. NOUILLETAS, T. OHSAKO, M. OTTAVIANI, S. PAMELA, H. PARRAT, P. PASTOR, A.L. PECQUET, B. PÉGOURIÉ, Y. PEYSSON, I. PORCHY, C. PORTAFAIX, M. PREYNAS, M. PROU, J.M. RAHARIJAONA, N. RAVENEL, C. REUX, P. REYNAUD, M. RICHOU, H. ROCHE, P. ROUBIN, R. SABOT, F. SAINT-LAURENT, S. SALASCA, F. SAMAILLE, A. SANTIAGUIUSTINA, Y. SARAZIN, A. SEMEROK, J. SCHLOSSER, M. SCHNEIDER, M. SCHUBERT, F. SCHWANDER, J.L. SÉGUI, G. SELIG, P. SHARMA, J. SIGNORET, A. SIMONIN, S. SONG, E. SONNENDRUKER, F. SOURBIER, P. SPUIG, P. TAMAIN, M. TENA, J.M. THEIS, D. THOUVENIN, A. TORRE, J.M. TRAVÈRE, E. TSITRONE, J.C. VALLET, E. VAN DER PLAS, A. VATRY, J.M. VERGER, L. VERMARE, F. VILLECROZE, D. VILLEGAS, R. VOLPE, K. VULLIEZ, J. WAGREZ, T. WAUTERS, L. ZANI, D. ZARZOSO and X.L. ZOU
Nuclear Fusion, Volume 51, 094014, 2011

The Temporal Evolution in Plasma Potential during Laser Photo-Detachment used to Diagnose Electronegative Plasma
N. SIRSE, S. K. KARKARI, M. A. MUJAWAR, J. CONWAY and M. M. TURNER

Plasma Sources Science and Technology, 20, 055003, 2011

Steady State Long Pulse Tokamak Operation using Lower Hybrid Current Drive

A. BECOULET, G.T. HOANG, J.F. ARTAUD, Y.S. BAE, J. BELO, G. BERGER-BY, J.M. BERNARD, PH. CARA, A. CARDINALI, C. CASTALDO, S. CECCUZZI, R. CESARIO, M.H. CHO, J. DECKER, L. DELPECH, H.J. DO, A. EKEDAHL, J. GARCIA, P. GARIBALDI, M. GONICHE, D. GUILHEM, C. HAMLYN-HARRIS, J. HILLAIRET, Q.Y. HUANG, F. IMBEAUX, H. JIA, F. KAZARIAN, S.H. KIM, Y. LAUSENAZ, X. LITAUDON, R. MAGGIORA, R. MAGNE, L. MARFISI, S. MESCHINO, D. MILANESIO, F. MIRIZZI, P. MOLLARD, W. NAMKUNG, L. PAJEWSKI, L. PANACCIONE, S. PARK, H. PARK, Y. PEYSSON, A. SAILLE, F. SAMAILLE, G. SCHETTINI, M. SCHNEIDER, P.K. SHARMA, A. TUCCILLO, O. TUDISCO, G. VECCHI, R. VILLARI, K. VULLIEZ, Y. WU, H.L. YANG, Q. ZENG
Fusion Engineering and Design, 86, 490-496 2011



An Indian Test Facility to Characterise Diagnostic Neutral Beam for ITER

M.J. SINGH, M. BANDYOPADHYAY, C. ROTTI, N.P. SINGH, SEJAL SHAH, G. BANSAL, A. GAHLAUT, J. SONI, H. LAKDAWALA, HARSHAD WAGHELA, I. AHMED, G. ROOPESH, U.K. BARUAH, A.K. CHAKRABORTY

Fusion Engineering and Design, 86, 732-735, 2011

Bends in Oversized Rectangular Waveguide

S. MESCHINO, S. CECCUZZI, F. MIRIZZI, L. PAJEWSKI, G. SCHETTINI, J.F. ARTAUD, Y.S. BAE, J.H. BELO, G. BERGER-BY, J.M. BERNARD, A. CARDINALI, C. CASTALDO, R. CESARIO, J. DECKER, L. DELPECH, A. EKEDAHL, J. GARCIA, P. GARIBALDI, M. GONICHE, D. GUILHEM, H. JIA, Q.Y. HUANG, J. HILLAIRET, G.T. HOANG, F. IMBEAUX, F. KAZARIAN, S.H. KIM, X. LITAUDON, R. MAGGIORA, R. MAGNE, L. MARFISI, D. MILANESIO, W. NAMKUNG, L. PANACCIONE, Y. PEYSSON, P.K. SHARMA, M. SCHNEIDER, A.A. TUCCILLO, O. TUDISCO, G. VECCHI, R. VILLARI, K. VULLIEZ

Fusion Engineering and Design, 86, 746-749, 2011

Contribution to the Design of the Main Transmission Line for the ITER Relevant LHCD System

F. MIRIZZI, S. CECCUZZI, S. MESCHINO, J.F. ARTAUD, J.H. BELO, G. BERGER-BY, J.M. BERNARD, A. CARDINALI, C. CASTALDO, R. CESARIO, J. DECKER, L. DELPECH, A. EKEDAHL, J. GARCIA, P. GARIBALDI, M. GONICHE, D. GUILHEM, G.T. HOANG, H. JIA, Q.Y. HUANG, J. HILLAIRET, F. IMBEAUX, F. KAZARIAN, S.H. KIM, X. LITAUDON, R. MAGGIORA, R. MAGNE, L. MARFISI, D. MILANESIO, W. NAMKUNG, L. PAJEWSKI, L. PANACCIONE, Y. PEYSSON, P.K. SHARMA, G. SCHETTINI, M. SCHNEIDER, A.A. TUCCILLO, O. TUDISCO, G. VECCHI, R. VILLARI, K. VULLIEZ, Y.S. BAE

Fusion Engineering and Design, 86, 759-762, 2011

Proposed High Voltage Power Supply for the ITER Relevant Lower Hybrid Current Drive System

P.K. SHARMA, F. KAZARIAN, P. GARIBALDI, T. GASSMANN, J.F. ARTAUD, Y.S. BAE, J. BELO, G. BERGER-BY, J.M. BERNARD, PH. CARA, A. CARDINALI, C. CASTALDO, S. CECCUZZI, R. CESARIO, J. DECKER, L. DELPECH, A. EKEDAHL, J. GARCIA, M. GONICHE, D. GUILHEM, C. HAMLYN-HARRIS, J. HILLAIRET, G.T. HOANG, H. JIA, Q.Y. HUANG, F. IMBEAUX, S.H. KIM, Y. LAUSENAZ, R. MAGGIORA, R. MAGNE, L. MARFISI, S. MESCHINO, D. MILANESIO, F. MIRIZZI, W. NAMKUNG, L. PAJEWSKI, L. PANACCIONE, Y. PEYSSON, A. SAILLE, G. SCHETTINI, M. SCHNEIDER, P.K. SHARMA, A.A. TUCCILLO, O. TUDISCO, R. VILLARI, K. VULLIEZ, Y. WU, Q. ZENG

SSON, A. SAILLE, G. SCHETTINI, M. SCHNEIDER, O. TUDISCO, G. VECCHI, S.R. VILLARI, K. VULLIEZ, Y. WU, Q. ZENG

Fusion Engineering and Design, 86, 819-822, 2011

RF Modeling of the ITER-Relevant Lower Hybrid Antenna
J. HILLAIRET, S. CECCUZZI, J. BELO, L. MARFISI, J.F. ARTAUD, Y.S. BAE, G. BERGER-BY, J.M. BERNARD, PH. CARA, A. CARDINALI, C. CASTALDO, R. CESARIO, J. DECKER, L. DELPECH, A. EKEDAHL, J. GARCIA, P. GARIBALDI, M. GONICHE, D. GUILHEM, G.T. HOANG, H. JIA, Q.Y. HUANG, F. IMBEAUX, F. KAZARIAN, S.H. KIM, Y. LAUSENAZ, R. MAGGIORA, R. MAGNE, S. MESCHINO, D. MILANESIO, F. MIRIZZI, W. NAMKUNG, L. PAJEWSKI, L. PANACCIONE, Y. PEYSSON, A. SAILLE, G. SCHETTINI, M. SCHNEIDER, P.K. SHARMA, A.A. TUCCILLO, O. TUDISCO, G. VECCHI, R. VILLARI, K. VULLIEZ, Y. WU, Q. ZENG

Fusion Engineering and Design, 86, 823-826, 2011

Benchmark of Coupling Codes (ALOHA, TOPLHA and GRILL3D) with ITER-Relevant Lower Hybrid Antenna

D. MILANESIO, J. HILLAIRET, L. PANACCIONE, R. MAGGIORA, J.F. ARTAUD, Y.S. BAE, A.M.A. BARBERA, J. BELO, G. BERGER-BY, J.M. BERNARD, PH. CARA, A. CARDINALI, C. CASTALDO, S. CECCUZZI, R. CESARIO, J. DECKER, L. DELPECH, A. EKEDAHL, J. GARCIA, P. GARIBALDI, M. GONICHE, D. GUILHEM, C. HAMLYN-HARRIS, G.T. HOANG, H. JIA, Q.Y. HUANG, F. IMBEAUX, S.H. KIM, Y. LAUSENAZ, R. MAGNE, L. MARFISI, S. MESCHINO, F. MIRIZZI, W. NAMKUNG, L. PAJEWSKI, Y. PEYSSON, A. SAILLE, G. SCHETTINI, M. SCHNEIDER, P.K. SHARMA, A.A. TUCCILLO, O. TUDISCO, R. VILLARI, K. VULLIEZ, Y. WU, Q. ZENG

Fusion Engineering and Design, 86, 827-830, 2011

ITER DNB Ion Source Movement Mechanism

M. BANDYOPADHYAY, IRFAN AHMED, G. ROOPESH, M.J. SINGH, C. ROTTI, S. SHAH, A. PHUKAN, R.K. YADAV, A.K. CHAKRABORTY

Fusion Engineering and Design, 86, 864-867, 2011

High Voltage Power Supplies for ITER RF Heating and Current Drive Systems

T.GASSMANN, B. ARAMBHADIYA, B.BEAUMONT, U.K. BARUAH, T.BONICELLI, C.DARBOS, D.PUROHIT, H.DECAMPS, F.ALBAJAR, F.GANDINI, M.HENDERSON, F.KAZARIAN, P.U.LAMALLE, T.OMORI, D.PARMAR, A.PATEL, D.RATHI, N.P.SINGH

Fusion Engineering and Design, 86, 884-887, 2011

Design Optimization of the 100 kV HV Bushing for ITER-DNB

SEJAL SHAH, S. RAJESH, B. SRUSTI, M. BANDYO-PADHYAY, C. ROTTI, M. J. SINGH, G. ROOPESH, A. K. CHAKRABORTY, B. SCHUNKE, R. HEMSWORTH, J. CHAREYRE

Fusion Engineering and Design, 86, 892-895, 2011

Mode Filters for Oversized Transmission Lines

S. CECCUZZI, S. MESCHINO, F. MIRIZZI, J.F. ARTAUD, Y.S. BAE, J. BELO, G. BERGER-BY, J.M. BERNARD, PH. CARA, A. CARDINALI, C. CASTALDO, R. CESARIO, J. DECKER, L. DELPECH, A. EKEDAHL, J.GARCIA, P. GARIBALDI, M. GONICHE, D. GUILHEM, J. HILLAIRET, G.T. HOANG, Q.Y. HUANG, F. IMBEAUX, H. JIA, S.H. KIM, Y. LAUSENAZ, R. MAGGIORA, R. MAGNE, L. MARFISI, D. MILANESIO, W. NAMKUNG, L. PAJEWSKI, L. PANACCIONE, Y. PEYSSON, A. SAILLE, G. SCHETTINI, M. SCHNEIDER, P.K. SHARMA, A.A. TUCCILLO, O. TUDISCO, G. VECCHI, R. VILLARI, K. VULLIEZ, Y. WU, Q. ZENG

Fusion Engineering and Design, 86, 909-912, 2011

An Overview of the ITER EC H&CD System and its Capabilities

T. OMORI, M.A. HENDERSON, F. ALBAJAR, S. ALBERTI, U. BARUAH, T. BIGELOW, B. BECKETT, R. BERTIZZOLO, T. BONICELLI, A. BRUSCHI, J. CAUGHMAN, R. CHAVAN, S. CIRANT, A. COLLAZOS, C. COX, C. DARBOS, M. DE BAAR, G. DENISOV, D. FARINA, F. GANDINI, T. GASSMANN, T.P. GOODMAN, R. HEIDINGER, J.P. HOGGE, S. ILLY, O. JEAN, J. JIN, K. KAJIWARA, W. KASPAREK, A. KASUGAI, S. KERN, N. KOBAYASHI, H. KUMRIC, J.D. LANDIS, A. MORO, C. NAZARE, Y. ODA, I. PAGONAKIS, B. PIOSCZYK, P. PLATANIA, B. PLAUM, E. POLI, L. PORTE, D. PUROHIT, G. RAMPONI, S. L. RAO, D. A. RASMUSSEN, D. M.S. RONDEN, T. RZESNICKI, G. SAIBENE, K. SAKAMOTO, F. SANCHEZ, T. SCHERER, M. SHAPIRO, C. SOZZI, P. SPAEH, D. STRAUSS, O. SAUTER, K. TAKAHASHI, R.J. TEMKIN, M. THUMM, M.Q. TRAN, V.S. UDINTSEV, H. ZOHN

Fusion Engineering and Design, 86, 951-954, 2011

An Overview of Control System for the ITER Electron Cyclotron System

D. PUROHITA, T. BIGELOW, D. BILLAVA, T. BONICELLI, J. CAUGHMAN, C. DARBOS, G. DENISOV, F. GANDINI, T. GASSMANN, M. HENDERSON, J.Y. JOURNEUX, K. KAJIWARA, N. KOBAYASHI, C. NAZARE, Y. ODA, T. OMORI, S.L. RAO, D. RASMUSSEN, D.

RONDEN, G. SAIBENE, K. SAKAMOTO, F. SARTORI, K. TAKAHASHI, R. TEMKIN

Fusion Engineering and Design, 86, 959-962, 2011

Fabrication and Characterization of Tungsten and Graphite Based PFC for Divertor Target Elements of ITER like Tokamak Application

S.S. KHIRWADKAR, K.P. SINGH, Y.PATIL, M.S. KHAN, J.J.U. BUCH, ALPESH PATEL, SUDHIR TRIPATHI, P.M. JAMAN, L. RANGARAJ, C. DIVAKAR

Fusion Engineering and Design, 86, 1736-1740, 2011

Pre-qualification of Brazed Plasma Facing Components of Divertor Target Elements for ITER like Tokamak Application

K.P. SINGH, SANTOSH P. PANDYA, S.S. KHIRWADKAR, ALPESH PATEL, Y. PATIL, J.J.U. BUCH, M.S. KHAN, SUDHIR TRIPATHI, SHWETANG PANDYA, J. GOVINDRAJAN, P.M. JAMAN, DEVENDRA RATHORE, L. RANGARAJ, C. DIVAKAR

Fusion Engineering and Design, 86, 1741-1744, 2011

ITER Cryostat - An Overview and Design Progress

BHARAT DOSHI, CAIPIN ZHOU, KIMIHIRO IOKI, HAN XIE, G. GUPTA, ANIL BHARDWAJ, A. TERASAWA, ITER CRYOSTAT TEAM

Fusion Engineering and Design, 86, 1924-1927, 2011

ITER Test Blanket Module Error Field Simulation Experiments at DIII-D

M.J. SCHAFFER, J.A. SNIPES, P. GOHIL, P. DE VRIES, T.E. EVANS, M.E. FENSTERMACHER, X. GAO, A.M. GAROFALO, D.A. GATES, C.M. GREENFIELD, W.W. HEIDBRINK, G.J. KRAMER, R.J. LA HAYE, S. LIU, A. LOARTE, M.F.F. NAVE, T.H. OSBORNE, N. OYAMA, J.-K. PARK, N. RAMASUBRAMANIAN, H. REIMERDES, G. SAIBENE, A. SALMI, K. SHINOHARA, D.A. SPONG, W.M. SOLOMON, T. TALA, Y.B. ZHU, J.A. BOEDO, V. CHUYANOV, E.J. DOYLE, M. JAKUBOWSKI, H. JHANG, R.M. NAZIKIAN, V.D. PUSTOVITOV, O. SCHMITZ, R. SRINIVASAN, T.S. TAYLOR, M.R. WADE, K.-I. YOU, L. ZENG and THE DIII-D TEAM

Nuclear Fusion, 51, 103028, 2011

Hot Vacuum Tribological Properties of Chromium Nitride Coatings against Austenitic Stainless Steel Type AISI 316LN and Colmonoy

A. DEVARAJU, A. ELAYAPERUMAL, S. VENUGOPAL, SATISH V. KAILAS, J. ALPHONSA

Applied Mechanics and Materials: Mechanical and Aerospace Engineering, 110 - 116, 600-605, 2011

Thermal and Mechanical Analysis of ITER-Relevant LHCD Antenna Elements

L. MARFISI, M. GONICHE, C. HAMLYN-HARRIS, J. HILLAIRET, J.F. ARTAUD, Y.S. BAE, J. BELO, G. BERGER-BY, J.M. BERNARD, PH. CARA, A. CARDINALI, C. CASTALDO, S. CECCUZZI, R. CESARIO, J. DECKER, L. DELPECH, A. EKEDAH, J. GARCIA, P. GARIBALDI, D. GUILHEM, G.T. HOANG, H. JIA, Q.Y. HUANG, F. IMBEAUX, F. KAZARIAN, S.H. KIM, Y. LAUSENAZ, R. MAGGIORA, R. MAGNE, S. MESCHINO, D. MILANESIO, F. MIRIZZI, W. NAMKUNG, L. PAJEWSKI, L. PANACCIONE, Y. PEYSSON, A. SAILLE, G. SCHETTINI, M. SCHNEIDER, P.K. SHARMA, A.A. TUCCILLO, O. TUDISCO, G. VECCHI, R. VILLARI, K. VULLIEZ, Y. WU, Q. ZENG

Fusion Engineering and Design, 86, 810-814, 2011

Determination of Ground and Excited State Dipole Moments of some Naphthols using Solvatochromic Shift Method

R. GAHLAUT, N. TEWARI, J.P. BRIDHKOTI, N.K. JOSHI, H.C. JOSHI, S. PANT

Journal of Molecular Liquids, 163, 141-146, 2011

Synthesis of Tailored 2D Sicf/Sic Ceramic Matrix Composites with BN/C Interphase Through ICVI

A. UDAYAKUMAR, P.M. RAOLE, M. BALASUBRAMANIAN

Journal of Nuclear Materials, 417, 363-366, 2011

Novel Mixed-Oxide Ceramic for Neutron Multiplication and Tritium Generation

DAKSHINAMOORTHY SATHIYAMOORTHY, S.J. GHANWAT, B.M. TRIPATHI, CHANDAN DANANI

Journal of Nuclear Materials, 417, 775-779, 2011

Heat Flux Reduction by Helical Divertor Coils in the Helio-tron Fusion Energy Reactor

N. YANAGI, A. SAGARA, T. GOTO, S. MASUZAKI, T. MITO, G. BANSAL, Y. SUZUKI, Y. NAGAYAMA, K. NISHIMURA, S. IMAGAWA and O. MITARAI

Nuclear Fusion, 51,103017, 2011

Comparative Study of Aluminide Coatings on Mild Steel by Different Aluminizing Techniques

G. AVASTHI, M. MEHTA, D. AVTANI, N. JAMNAPARA, N. CHAUHAN, G. JHALA, G. GUPTA

2011 AIST Steel Properties and Applications Conference, Held in Conjunction with the Materials Science and Technology 2011 Conference and Exhibition, Columbus, 16-20 October 2011

Theory of Coupled Whistler-Electron Temperature Gradient Mode in High Beta Plasma: Application to Linear Plasma Device

S. K. SINGH, L. M. AWASTHI, R. SINGH, P. K. KAW, R. JHA, and S. K. MATTOO

Physics of Plasmas, 18, 102109, 2011

Comparative Studies on Charged Particle Flow in a Double Plasma Device

M. CHAKRABORTY and B. K. DAS

Physics of Plasmas, 18, 103501, 2011

Measurements of Time Average Series Resonance Effect in Capacitively Coupled Radio Frequency Discharge Plasma

B. BORA, H. BHUYAN, M. FAVRE, E. WYNDHAM, H. CHUAQUI, AND M. KAKATI

Physics of Plasmas, 18, 103509, 2011

Detection Efficiency vs. Cathode and Anode Separation in Cylindrical Vacuum Photodiodes used for Measuring X-Rays from Plasma Focus Device

T. K. BORTHAKUR, N. TALUKDAR, N. K. NEOG, C. V. S. RAO, and A. SHYAM

Review of Scientific Instruments, 82, 103507, 2011

High Density Plasma Beam Source for Nitriding

B. GANGULI

Indian Journal of Pure and Applied Physics, 49, 759-764, 2011

Shear Flows in Two Dimensional Strongly Coupled Yukawa Liquids: A Large Scale Molecular Dynamics Study

R. GANESH and J. ASHWIN

AIP Conference Proceedings, Volume 1397, Issue 1, pp. 78-85, November 2011

Optical Emission of Dusty RF Discharges: Experiment and Simulation

A. MELZER, S. HÜBNER, L. LEWERENTZ, K. MATYASH, R. SCHNEIDER, and V. R. IKKURTHI

AIP Conference Proceedings, Volume 1397, pp. 134-137, November 2011

Secondary Electron Emission from Dust and its Effect on Charging

B. K. SAIKIA, B. KAKATI, S. S. KAUSIK, and M. BANDYOPADHYAY

AIP Conference Proceedings, Volume 1397, pp. 231-232, November 2011

- Effect of Electrostatic Confinement on Charging of Dust Grains
S. S. KAUSIK, B. KAKATI, and B. K. SAIKIA
AIP Conference Proceedings, Volume 1397, pp. 239-240, November 2011
- Phase-locked Solutions and their Stability in the Presence of Propagation Delays
G.C. SETHIA, A. SEN, F.M. ATAY
Pramana, 77, 905-915, 2011
- Collisionless Stopping of Electron Current in an Inhomogeneous Electron Magnetohydrodynamics Plasma
AMITA DAS, SHARAD K YADAV, PREDHIMAN KAW and SUDIP SENGUPTA
Pramana, 77, 949-957, 2011
- Purification of Niobium Oxide by Dissolution and Solvent Extraction
K.C. NATHSARMA, B.B. NAYAK, P. BRAHMBHATT, S. PRADHAN
Minerals and Metallurgical Processing, 28, 204-207, 2011
- Excitation of Electrostatic Plasma Waves Using A Dielectric Covered Metallic Electrode
S. KAR and S. MUKHERJEE
Physics of Plasmas, 18, 112303, 2011
- Relativistic Electromagnetic Flat Top Solitons and their Stability
SITA SUNDAR, AMITA DAS, VIKRANT SAXENA, PREDHIMAN KAW, and ABHIJIT SEN
Physics of Plasmas, 18, 112112, 2011
- Radial Transport of Energetic Ions in the Presence of Trapped Electron Mode Turbulence
J. CHOWDHURY, W. WANG, S. ETHIER, J. MANICKAM, and R. GANESH
Physics of Plasmas, 18, 112510, 2011
- Soft X-Ray Array System with Variable Filters for the DIII-D Tokamak
E. M. HOLLMANN, L. CHOUSAL, R. K. FISHER, R. HERNANDEZ, G. L. JACKSON, M. J. LANCTOT, S. V. PIDCOE, J. SHANKARA, and D. A. TAUSSIG
Review of Scientific Instruments, 82, 113507, 2011
- Low-frequency Fluctuations in Scrape-Off Layer of Tokamak Plasma with Limiter Biasing
N. BISAI, RAMESWAR SINGH and R. SINGH
Journal of Plasma Physics, 77, 733-748, 2011
- Fluorescence Characteristics of 5-Aminoquinoline in Acetonitrile: Water
J.P. BRIDHKOTI, H.C. JOSHI, S. PANT
Journal of Molecular Liquids, 164, 197-200, 2011
- Existence and Stability of Traveling-Wave States in a Ring of Nonlocally Coupled Phase Oscillators with Propagation Delays
GAUTAM C. SETHIA and ABHIJIT SEN
Physical Review E, 84, 066203, 2011
- Nonlinear Oscillations and Waves in an Arbitrary Mass Ratio Cold Plasma
PRABAL SINGH VERMA
Physics of Plasmas, 18, 122111, 2011
- Investigation on the High Vacuum Tribological Characteristics of Surface Treated Nuclear Grade Stainless Steel Type AISI 316 LN at 25 to 500 °C
AYYANNAN DEVARAJU, AYYASAMY ELAYAPERUMAL, SRINIVASAN VENUGOPAL, SATISH V. KAILAS, JOSEPH ALPHONSA
Journal of Mechanical Engineering, 57, 927-935, 2011
- Deposition and Qualification of Tungsten Coatings Produced by Plasma Deposition in WF6 Precursor Gas
V PHILIPPS, D KOGUT, H G ESSER, G SERGIENKO, M ZLOBINSKI, J W COENEN, S BREZINSEK, F NACHTRODT and A K SANYASI
Physica Scripta, 2011, T145, 014030, 2011
- Numerical Investigation of the Ion Temperature Effect in Magnetized Plasma Sheath with Two Species of Positive Ions
A. K. SHAW, S. KAR, K. S. GOSWAMI, and B. J. SAIKIA
Physics of Plasmas, 19, 012120, 2012
- Longitudinal Singular Response of Dusty Plasma Medium in Weak and Strong Coupling Limits
SANAT KUMAR TIWARI, AMITA DAS, PREDHIMAN KAW and ABHIJIT SEN
Physics of Plasmas, 19, 013706, 2012
- Influence of Plasma Loss Area on Transport of Charged Particles through a Transverse Magnetic Field
B. K. DAS, M. BANDYOPADHYAY, and M. CHAKRABORTY
Physics of Plasmas, 19, 013504, 2012
- Symmetry Breaking Effects of Density Gradient on Parallel Momentum Transport: A new ρ^*s Effect
RAMESWAR SINGH, R. SINGH, P. KAW, O. D. GURCAN, P. H. DIAMOND, and H. NORDMAN
Physics of Plasmas, 19, 012301, 2012

Effects of Pressure Gradients on Laser Beam Propagation through an Optical Window for Tokamak Plasma Diagnostics
RAJ KUMAR, RANJEET SINGH, KAUSHAL PANDYA, and AJAI KUMAR

Fusion Science and Technology, 61, 51-56, 2012

The ITER Heat Rejection Challenge

STEVE PLOYHAR, WARREN CURD, AJITH KUMAR, GIOVANNI DELL'ORCO, BABULAL GOPALAPILLAI, DINESH GUPTA, HIREN PATEL, KEUN-PACK CHANG, FAN LI, FABIO SOMBOLI, LILIANA TEODOROS

Fusion Science and Technology, 61, 107-112, 2012

Design Features of ITER Cooling Water Systems to Minimize Environmental Impacts

BABULAL GOPALAPILLAI, WARREN CURD, STEVE PLOYHAR, GIOVANNI DELL'ORCO, KEUN-PACK CHANG, FAN LI, FABIO SOMBOLI, ANDREI PETROV, DINESH GUPTA, AJITH KUMAR

Fusion Science and Technology, 61, 113-118, 2012

Design and development of Five-Channel Interference Filter Polychromator for SST-1 Thomson Scattering System

JINTO THOMAS, AJAI KUMAR, VISHNU CHAUDHARI, KAUSHAL PANDYA, RANJEET SINGH

Fusion Engineering and Design, 87, 134-140, 2012

Measurement of Tritium Production Rate Distribution in Natural LiAlO₂/HDPE Assembly Irradiated by D-T Neutrons

SHRICHAND JAKHAR, MITUL ABHANGI, C.V.S. RAO, T.K. BASU, SONALI P.D. BHADE, PRIYANKA J. REDDY

Fusion Engineering and Design, 87, 184-187, 2012

Laser-cluster Interaction with Subcycle Pulses

M. KUNDU, P. K. KAW and D. BAUER

Physical Review A, 85, 023202, 2012

A Bright Point Source of Ultrashort Hard X-Ray Pulses using Biological Cells

M. KRISHNAMURTHY, S. MONDAL, A.D. LAD, K. BANE, S. AHMED, V. NARAYANAN, R. RAJEEV, G. CHATTERJEE, P.K. SINGH, G.R. KUMAR, M. KUNDU, K. RAY

Optics Express, 20, 5754-5761, 2012

Multiple Delivery Cesium Oven System for Negative Ion Sources

G. BANSAL, S. BHARTIYA, K. PANDYA, M. BANDYOPADHYAY, M. J. SINGH, J. SONI, A. GAHLAUT, K. G. PARMAR, and A. CHAKRABORTY

Review of Scientific Instruments, 83, Issue 2, 02B118, 2012

Optimization of Negative Ion Current in a Compact Microwave Driven Upper Hybrid Resonance Multicusp Plasma Source

D. SAHU, S. BHATTACHARJEE, M. J. SINGH, M. BANDYOPADHYAY, and A. CHAKRABORTY

Review of Scientific Instruments, Volume 83, 02A706, 2012

Kelvin-Helmholtz Instability in a Weakly Coupled Dust Fluid

SANAT KUMAR TIWARI, AMITA DAS, PREDHIMAN KAW, AND ABHIJIT SEN

Physics of Plasmas, 19, 023703, 2012

Study of Pulsed Plasma Across A Spatial Length Inside Curved Chamber using Cylindrical Double Probe

N. SASINI, R. PAIKARAY, G. SAHOO, D. C. PATRA, J. GHOSH and A. SANYASI

Indian Journal of Physics, 86, 151-155, 2012

Dissipative Drift Instability in Dusty Plasma

NILAKSHI DAS and SWATI BARUAH

AIP Advances, 2, 012113, 2011

Polymer Micro-Environmental Effects on the Fluorescence Characteristics of 5-Aminoquinoline and 3-Aminoquinoline

J.P. BRIDHKOTI, H.C. JOSHI, S. PANT

Journal of Luminescence, 132, 722-729, 2012

Bernstein-Greene-Kruskal Waves in Relativistic Cold Plasma
PRABAL SINGH VERMA, SUDIP SENGUPTA, and PREDHIMAN KAW

Physics of Plasmas, 19, 032110, 2012

Coherent to Turbulence Transition, Enhanced Flow and Confinement in a Simple Toroidal Plasma

T. S. GOUD, R. GANESH, Y. C. SAXENA, D. RAJU, K. SATHYANARAYANA, K. K. MOHANDAS, and C. CHAVDA

Physics of Plasmas, 19, 032307, 2012

Ponderomotive Ion Acceleration in Dense Magnetized Laser-Irradiated Thick Target Plasmas

UJJWAL SINHA and PREDHIMAN KAW

Physics of Plasmas, 19, 033102, 2012

Breaking of Longitudinal Akhiezer-Polovin Waves

PRABAL SINGH VERMA, SUDIP SENGUPTA, and PREDHIMAN KAW

Physical Review Letters, 108, 125005 2012

SST-1 Status and Plans

S. PRADHAN, A.N. SHARMA, V.L. TANNA, Z. ZKHAN, U. PRASAD, K. DOSHI, D.C. RAVAL, F. KHAN, N.C. GUPTA, J. TANK, M.K. GUPTA, P. SANTRA, P. BISWAS, T. PAREKH, H. MASAND, D. SHARMA, A. SRIVASTAVA, H. PATEL
IEEE Transactions on Plasma Science, 40, 614-621, 2012

Precision Signal Conditioning Electronics for Cryogenic Temperature and Magnetic Field Measurements in SST-1

K. DOSHI, Y. KHRISTI, A.N. SHARMA, P. VARMORA, S. KEDIA, U. PRASAD, D. PATEL, S. PRADHAN
IEEE Transactions on Plasma Science, 40, 641-645, 2012

Three Region Model and Quantum Enhancement of Thermionic and Photoelectric Electron Emission from Negatively Charged Metallic Surfaces

SUJEET AGARWAL, SHIKHA MISRA, S.K. MISHRA, M.S. SODHA
Canadian Journal of Physics, 90, 265-275, 2012

Comparison of Thermal Evaporation and Plasma Assisted Thermal Evaporation Processes for Deposition of Tin Oxide Thin Films

C. JARIWALA, T. GARG, R. RANE, N. CHAUHAN, P.A. RAYJADA, C.J. PANCHAL and P.I. JOHN
Journal of Nano- and Electronic Physics, 3, 318-322, 2011

Effect of Filament Position on Diffused Plasma Parameters

MONOJIT CHAKRABORTY, BIDYUT K. DAS, MRINAL K. MISHRA, and MAINAK BANDYOPADHYAY
Chinese Journal of Physics, 49, 1199, 2011

Characterization of Laser Beam Welded SS 304 and SS 316 Materials for Fusion Reactor Applications

B. RAMESH KUMAR and R.GANGRADEY
International Journal of Manufacturing Technology and Industrial Engineering, 2, 25-29, 2011

Survey of EUV Impurity Line Spectra and EUV Bremsstrahlung Continuum in LHD

CHUNFENG DONG, SHIGERU MORITA, MALAY BIKAS CHOWDHURI AND MOTOSHI GOTO
Plasma and Fusion Research, 6, 2402078, 2011

RF Sources for ITER Ion Cyclotron H&CD System

F. KAZARIAN, B. BEAUMONT, B. ARAMBHADIYA, T. GASSMANN, PH. LAMALLE, D. RATHI, A. MUKHERJEE, P. AJESH, H. MACHCHHAR, D. PATADIA, M. PA-

TEL, K. RAJNISH, R. SINGH, G. SUTHAR, R. TRIVEDI, R. KUMAZAWA, T. SEKI, K. SAITO, H. KASAHARA, T. MUTOH, F. SHIMPO and G. NOMURA

Fusion Engineering and Design, 86, 888-891, 2011

Design Finalization and Start of Construction of ITER Vacuum Vessel

K. IOKI, V. BARABASH, C.H. CHOI, J.-J. CORDIER, E. DALY, S. DANI, J. DAVIS, B. GIRAUD, Y. GRIBOV, PH. HEITZENROEDER, C. HAMLYN-HARRIS, G. JOHN-SON, L. JONES, C. JUN, B.C. KIM, E. KUZMIN, R. LE BARBIER, D. LOESSER, J.-M. MARTINEZ, M. MERO-LA, H. PATHAK, J. PREBLE, J. REICH, J.W. SA, A. TERASAWA, YU. UTIN, X. WANG and S. WU

Fusion Engineering and Design, 86, 593-597, 2011

Generation of Cold Electrons in the Downstream Region of a Microwave Plasma Source with Near Boundary Resonances for Production of Negative Ions

D. SAHU, S. BHATTACHARJEE, M. BANDYOPADHYAY and A. CHAKRABORTY

Indian Journal of Physics, 85, 1871-1878, 2011

Bolometers for Fusion Plasma Diagnostics

KUMUDNI TAHILIANI and RATNESHWAR JHA
Bolometers, Edited by Unil Perera, Published by InTech, pages 151-170, 2012
ISBN 979-953-307-348-3 (Book Chapter)

E 2. TECHNICAL REPORTS

Simplified and Cost Effective Method of Temperature Sensors Testing at 4.2K using Liquid Helium (LHe) Transport Dewar

DIPAK PATEL, A.N. SHARMA, PANKAJ VARMORA, UPENDRA PRASAD and S. PRADHAN
IPR/TR-174/2011 (MAY, 2011)

Development of Fast, Compact ~ 300kV, 1.8kJ Marx Generator for Directly Driving Virtual Cathode Oscillator Type High Power Microwave Device

BISWAJIT ADHIKARY, RAJESH KUMAR, R. SHUKLA, S.K. SHARMA, P.BANERJEE, P.DEB, T. PRABHAKARAN, R.DAS, B.K. DAS and A. SHYAM
IPR/TR-175/2011 (MAY, 2011)

Engineering Design of 750KW, 91.2 MHz Amplifier

RAJ SINGH
IPR/TR-176/2011 (JUNE, 2011)



Microstructural Studies of Electrospark Deposited Aluminide Coatings on Reduced Activation 9Cr Steels

NIRAV I. JAMNAPARA, STEFANO FRANGINI, DILIP AVTANI, VISHAL NAYAK, N.L. CHAUHAN, G.JHALA, S. MUKHERJEE, and A.S. KHANNA
IPR/TR-177/2011(JUNE, 2011)

In-House Facility for Maintenance and Repairing Experience of Vacuum Pumps, Problems and Solutions

RAJIV SHARMA, HIREN NIMAVAT, MANOJ SINGH, SUMAN KARKARI, V.L. TANNA and S. PRADHAN
IPR/TR-178/2011 (JUNE, 2011)

Engineering Design of Gas Discharge Hydrogen Cyanide Laser

ASHA ADHIYA, PABITRA KUMAR MISHRA and RAJWINDER KAUR
IPR/TR-179/2011 (JUNE, 2011)

Core-Ion Temperature Measurement of Aditya Tokamak using Passive Charge Exchange Neutral Particle Energy Analyzer

SANTOSH P. PANDYA, KUMAR AJAY, PRIYANKA MISHRA, RAJANI D. DHINGRA and J. GOVINDARAJAN
IPR/TR-180/2011 (AUGUST, 2011)

Two Series Ignitron Crowbar System for 82.6GHz Gyrotron for ECRH in SST-1

MAHESH KUSHWAH, B K SHUKLA, RAJAN BABU, ANURAG SHYAM, S LAXMIKANT RAO, JATIN PATEL, HARSHIDA PATEL, VIPAL RATHOD, RONAK SHAH, PRAGNESH DHORAJIYA, ANJALI SHARMA, SATISH D. PATEL and VISHAL BHAVSAR
IPR/TR-181/2011 (AUGUST, 2011)

High Power CW Test of 82.6GHz Gyrotron

B K SHUKLA, MAHESH KUSHWAH, RAJAN BABU, JATIN PATEL, K. SATHYANARAYANA, S LAXMIKANT RAO, PRAGNESH DHORAJIYA, HARSHIDA PATEL, SUNIL BELSARE, VIPAL RATHOD, SATISH D. PATEL, VISHAL BHAVSAR, PRIYANKA A SOLANKI, ANJALI SHARMA, RONAK SHAH, MIKHAIL SHMELEV, YURY BELOV and VLADIMIR BELOUSOV
IPR/TR-182/2011 (AUGUST, 2011)

High Power Test of CVD Diamond Window for ECRH System in SST-1

B K SHUKLA, RAJAN BABU, MAHESH KUSHWAH, K. SATHYANARAYANA, JATIN PATEL, S LAXMIKANT RAO, PRAGNESH DHORAJIYA, HARSHIDA PATEL, SUNIL BELSARE, VIPAL RATHOD, SATISH D. PATEL, VISHAL BHAVSAR, PRIYANKA A SOLANKI, ANJALI SHARMA, RONAK SHAH, MIKHAIL SHMELEV, YURY BELOV and VLADIMIR BELOUSOV
IPR/TR-183/2011 (AUGUST, 2011)

Testing of Bridge Type Joint for PF3 Repair in Current Lead Test Setup

A. N. SHARMA, U.PRASAD, S. PRADHAN, N.C. GUPTA, V.L. TANNA, P. VARMORA, D. PATEL
IPR/TR-184/2011 (AUGUST, 2011)

Analysis of N₂ Gas Heating and Supply System for SST-1 Vacuum Vessel and Plasma Facing Components Baking

YUVAKIRAN PARAVASTU, ZIAUDDIN KHAN, FIROZKHAN PATHAN, SIJU GEORGE, GATTU RAMESH, SUBRATA PRADHAN and SST-1 VACUUM DIVISION
IPR/TR-185/2011 (AUGUST, 2011)

Programmable Pulse Generator for Aditya Gas Puffing System

NARENDRA PATEL, CHHAYA CHAVDA, S. B. BHATT, PRABAL CHATTOPADHYAY, and Y.C. SAXENA
IPR/TR-186/2011 (AUGUST, 2011)

SST-1 Vacuum Data Acquisition and Control System

KALPESH R. DHANANI, ZIAUDDIN KHAN and SST-1 VACUUM DIVISION
IPR/TR-187/2011 (SEPTEMBER, 2011)

Design and Development of CAMAC Based Eight Channel Delayed Pulse Generator

N C PATEL, CHHAYA CHAVDA, PRABAL CHATTOPADHYAY, Y.C. SAXENA
IPR/TR-188/2011 (OCTOBER, 2011)

70kV, 22A DC Power Supply for Testing of High Power RF and Microwave Tubes

YSS SRINIVAS, N RAJAN BABU, KM PARMAR, BHAVESH KADIA, CHETAN VIRANI, PRAGNESH DHORAJIYA, JIGALRAJ VANSIA, SHEFALI DALAKOTI, DOSHI RAVIKUMAR, BRAHMBHATT TUSHAR, PATIL GAJENDRA, ANIL VISHWAKARMA and SV KULKARNI
IPR/TR-189/2011 (OCTOBER, 2011)

Strap Joint Resistance Analysis for Second Generation YBCO Coated Conductor

ANANYA KUNDU, PIYUSH RAJ, SUBRATA PRADHAN
IPR/TR-190/2011 (OCTOBER, 2011)

High Heat Flux Tests of Divertor Macro Brush Type Mock-Ups

Y. PATIL, D. KRISHNAN, A. PATEL, S.S.KHIRWADKAR and PROTOTYPE DIVERTORS DIVISION OF IPR
IPR/TR-191/2011 (NOVEMBER, 2011)

Ultrasonic Diagnostic for Superconducting Magnets Winding Pack Joint Quality Control of SST-1

UPENDRA PRASAD, A.N.SHARMA, D.PATEL, MAGNET DIVISION and S.PRADHAN
IPR/TR-192/2011 (NOVEMBER, 2011)

Design, Fabrication, Testing and Integration of 1.5 kV, 1.5A Screen Grid Power Supply for 200 kW, 91.2 MHz CWRF Amplifier

BHAVESH R KADIA, YSS SRINIVAS, SALMAN ANSARI, H.M. JADAV, S.V. KULKARNI and ICRH GROUP
IPR/TR-193/2011 (NOVEMBER, 2011)

The Electric Field Measurement using Indigenously Developed RF Modulated Dipole Probe

P. K. SRIVASTAVA, L. M. AWASTHI, G. RAVI, SUNIL KUMAR and S. K. MATTOO
IPR/TR-194/2011 (NOVEMBER, 2011)

Data Acquisition and Control System Software for 91.2 MHz 1.5 MW (ICRH) System for (SST1)

RAMESH JOSHI, H M JADAV, MANOJ PARIHAR, B R KADIA, K M PARMAR, A VARIA, K MISHRA, Y S S SRINIVAS, R A YOGI, A GAYATRI, RAJ SINGH, SUNIL KUMAR and S.V. KULKARNI
IPR/TR-195/2011 (NOVEMBER, 2011)

High Availability of Servers

HEMANT JOSHI and SUTAPA RANJAN
IPR/TR-196/2011 (DECEMBER, 2011)

Commissioning of 11kV, 2MVA Voltage Variation System for High Power RF and Microwave Tubes

KIRIT PARMAR, Y.S.S. SRINIVAS, RAJAN BABU, S.V. KULKARNI and ICRH GROUP
IPR/TR-197/2012 (JANUARY, 2012)

Design of a Fast Scanning Langmuir Probe Drive for SST-1 Tokamak Divertor

PRABHAT KUMAR, RATNESHWAR JHA, M.V. GOPALAKRISHNA, KUMUDNI TAHILIANI
IPR/TR-198/2012 (JANUARY, 2012)

Stabilization of 25kW Plasma Torch (Graphite based) using IGBT Based Power Supply at FCIPT

C. PATIL, V. JAIN, B. PATEL, A. VISANI, V. CHAUHAN
IPR/TR-199/2012 (JANUARY, 2012)

Overview of Design and Thermal-hydraulic Analysis of Indian Solid Breeder Blanket Concept

PARITOSH CHAUDHURI, CHANDAN DANANI, VILAS CHAUDHURI, and E. RAJENDRA KUMAR
IPR/TR-200/2012 (JANUARY, 2012)

Purchase Information Collection Software (PICS)

PRIYANKA PATEL and S.S. KHIRWADKAR
IPR/TR-201/2012 (FEBRUARY, 2012)

A Design Report of Solar Panel Plasma Interaction Experiment (SPIX-II)

SURYAKANT B. GUPTA, KEENA KALARIA, NARESH VAGHELA, SUBROTO MUKHERJEE
IPR/TR-202/2012 (MARCH, 2012)

Development of Indigenous Glow Detector for Tokamak ADITYA

K.A. JADEJA, S.B. BHATT, B.N. DARJI and A.S. PRAJAPATI
IPR/TR-203/2012 (MARCH, 2012)

Technical Report on Development of Indoor High Voltage Switches for Moderate Currents

L.N. GUPTA, PARESH J. PATEL, N.P. SINGH, DIPAL THAKKAR, VISHNU PATEL, C.B. SUMOD, L.K. BANSAL, KARISHMA QURESHI, VIJAY VADHER and U.K. BARUAH
IPR/TR-204/2012 (MARCH, 2012)

Effect of Si on Hot Dip Aluminized 9Cr-1 Mo Steels and Subsequent Oxidation Studies

NIRAV I. JAMNAPARA, DILIP U. AVTANI, N. L. CHAUHAN, P.M. RAOLE, S. MUKHERJEE, A.S. KHANNA
IPR/TR-205/2012 (MARCH, 2012)

E 3. CONFERENCE PRESENTATION

Particle Accelerator Conference (PAC 2011), New York, NY, USA, March 28 - April 1, 2011

Spectroscopic Estimation of Plasma Parameters for ECR Ion source in the intense 14-MeV Neutron generator being developed at IPR

Santanu Banerjee, Sudhirsinh Vala, Mitul Abhangi, Payal Mehta, Nilam Ramaiya, Shrichand Jakhar, J.Ghosh, C V S Rao and T K Basu

AccApp-2011 - Tenth International Topical Meeting on Nuclear Application and Accelerator, Knoxville, TN, USA, 3-7 April 2011

Design and fabrication of ion Extraction system for 14-MeV Neutron Generator

SudhirsinhVala, ShrichandJakhar, MitulAbhangi, Rajnikant-Makwana, C.V.S.Rao and T.K.Basu

14th European Conference on Genetic Programming, EuroGP 2011, Torino, Italy, 27-29 April 2011

A Sniffer Technique for an Efficient Deduction of Model Dynamical Equations using Genetic Programming
D.P. Ahalpara, A. Sen



9th Workshop on Frontiers in Low Temperature Plasma Diagnostics, Greifswald /Zinnowitz, Germany, 09-12 May 2011

Diagnostics Performed to Measure Charge on Dust in Hot Cathode Discharge

B.K. Saikia, S.S. Kausik and B. Kakati

Graphita 2011, Gran Sasso National Laboratory, Italy, 15-18 May 2011

Synthesis of Stacked Graphene Sheets by a Supersonic Thermal Plasma Expansion Technique and the Affect of Sample Collection Chamber Pressure

M. Kakati

15th International Conference on Emerging Nuclear Energy Systems, Hyatt Hotel at Fisherman's Wharf, San Francisco, California, 15-19 May 2011

The ITER Heat Rejection Challenge

Steve Ployhar, Warren Curd, Ajith Kumar, Giovanni Dell'orco, Babulal Gopalapillai, Dinesh Gupta, Hiren Patel, Keun-Pack Chang, Fan Li, Fabio Somboli, Liliana Teodoros

Design Features of ITER Cooling Water Systems to Minimize Environmental Impacts

Babulal Gopalapillai, Warren Curd, Steve Ployhar, Giovanni Dell'orco, Keun-Pack Chang, Fan Li, Fabio Somboli, Andrei Petrov, Dinesh Gupta, Ajith Kumar

6th International Conference on the Physics of Dusty Plasmas, Garmisch-Partenkirchen, Germany, 16-20 May 2011

Shear Flows in Two Dimensional Strongly Coupled Yukawa Liquids: A Large Scale Molecular Dynamics Study

R. Ganesh and J. Ashwin

Optical Emission of Dusty RF Discharges: Experiment and Simulation

A. Melzer, S. Hübner, L. Lewerentz, K. Matyash, R. Schneider, and V. R. Ikkurthi

Simulations of Compressible Dust Ball

V. Saxena

Influence of Polarization Force on Jeans Instability of Dusty Plasma

R. P. Prajapati

Kelvin Helmholtz Instability in Dusty plasmas

S. K. Tiwari

Secondary Electron Emission from Dust and its Effect on Charging

B.K. Saikia, B. Kakati, S.S. Kausik and M. Bandyopadhyay

Effect of Electrostatic Confinement on Charging of Dust Grains

S.S. Kausik, B. Kakati and B.K. Saikia

20th Meeting of the ITPA Topical Group on Diagnostics, Noordwijk, Netherlands, 23-26 May 2011

Progress on X-ray Crystal Spectrometer for ITER (survey and edge high res.)

Sanjeev Varshney, Robin Barnsley and Martin O' Mullane

19th Topical Conference on Radio Frequency Power in Plasmas, Newport, 1-3 June 2011

A Simple Coaxial Ceramic Based Vacuum Window for Vacuum Transmission Line of ICRF System

D. Rathi, K. Mishra, S. Goerge, A. Varia, S. V. Kulkarni, and Icrh Team

Direct Electron Heating Observed by Fast Waves in ICRF Range on a Low-Density Low Temperature Tokamak ADITYA

K. Mishra, S. Kulkarni, D. Rathi, A. Varia, H. Jadav, K. Parmar, B. Kadia, R. Joshi, Y. Srinivas, R. Singh, S. Kumar, S. Dani, A. Gayatri, R. Yogi, M. Singh, Y. Joisa, C. Rao, S. Kumar, R. Jha, R. Manchanda, J. Ghosh, P. Atrey, S. Bhatt, C. Gupta, P. Chattopadhyaya, A. Chattopadhyaya, R. Srinivasan, D. Bora, P. Kaw, and Aditya Team

Long Pulse Operation with the ITER-Relevant LHCD Antenna in Tore Supra

A. Ekedahl, L. Delpech, M. Goniche, D. Guilhem, J. Hillairet, M. Preynas, P. K. Sharma, J. Achard, Y. S. Bae, X. Bai, C. Balorin, Y. Baranov, V. Basiuk, A. Becoulet, J. Belo, G. Berger-By, S. Bremond, C. Castaldo, S. Ceccuzzi, R. Cesario, E. Corbel, X. Courtois, J. Decker, E. Delmas, B. J. Ding, X. Ding, D. Douai, R. Dumont, C. Goletto, J. P. Gunn, P. Hertout, G. T. Hoang, F. Imbeaux, K. Kirov, X. Litaudon, P. Lotte, P. Maget, R. Magne, J. Mailloux, D. Mazon, F. Mirizzi, P. Mollard, P. Moreau, T. Oosako, V. Petrzilka, Y. Peysson, S. Poli, M. Prou, F. Saint-Laurent, F. Samaille

Lower Hybrid Current Drive Efficiency at High Density on Tore Supra

M. Goniche, P. K. Sharma, V. Basiuk, Y. Baranov, C. Castaldo, R. Cesario, J. Decker, L. Delpech, A. Ekedahl, J. Hillairet, K. Kirov, D. Mazon, T. Oosako, Y. Peysson, and M. Prou

Bremsstrahlung Emission Modelling and Application to Fast Electron Physics

J. Decker, Y. Peysson, J. F. Artaud, V. Basiuk, S. Coda, A. Ekedahl, S. Gnesin, M. Goniche, D. Mazon And P. Sharma

5th International Conference on Advances in Mechanical Engineering (ICAME-2011) held at SVNIT, Surat, 6-8 June-2011

Minimising Distortion in TIG welding of MS structures: A Taguchi approach

S. Akella, MV Ramana, Y Krishnaiah, M. Ramesh, B.RAMESH KUMAR

Characterization of SS 304 and SS 316 Laser Welded Samples for Fusion Reactor Applications

B.Ramesh Kumar, R. Gangradey

Integrated Modeling Technology Workshop, ITER Office, Caderache France, 8-9 June 2011

Code Structure and Data flow Management for Edge and SOL Integration

N. Bisai and ITM Team

Transactions of the Cryogenic Engineering Conference – CEC, (AIP Conference Proceedings 1434) held at Spokane, Washington, 13-17 June 2011

Adaptability of Optimization Concept in the Context of Cryogenic Distribution for Superconducting Magnets of Fusion Machine

B. Sarkar, R. Bhattacharya, H. Vaghela, N. Shah, K. Choukekar and S. Badgular

Preliminary System Design and Analysis of an Optimized Infrastructure for ITER Prototype Cryoline Test

N. Shah, R. Bhattacharya, B. Sarkar, S. Badgular, H. Vaghela, and P. Patel

38th IEEE International Conference on Plasma Science (ICOPS) & 24th Symposium on Fusion Engineering (SOFE 2011) held in Chicago, Illinois, USA, 26-30 June 2011

42GHz 0.5MW ECRH system for Tokamaks SST-1 and Aditya

B.K.Shukla, R.Goswami, R.Babu, J.Patel, P.K.Chattopadhyay, R.Srinivasan, H.Patel, P.Dhorajia

High power test of CVD diamond window for ECRH system in SST-1

B.K.Shukla, R. Babu, M. Kushwah, K. Sathyanarayana, J. Patel, S.L. Rao, D. Pragnesh, H. Patel, S. Belsare, R. Vipal, S.D. Patel, B. Vishal, A.S. Priyanka, S. Anjali, S. Ronak, M. Shmelev, Y. Belov, V. Belousov

SST-1 Status and Plans

S. Pradhan, A.N. Sharma, V.L. Tanna, Ziauddin Khan, U. Prasad, K. Doshi, D.C. Raval, F. Khan, N.C. Gupta, J. Tank, M.K. Gupta, P. Santra, P. Biswas, T. Parekh, H. Masand, D. Sharma, A. Srivastava, H. Patel and SST-1 Mission Team

Development of CuCrZr Alloy for Applications in Neutral Beams

C. Rotti, A.K.Chakraborty, I. Ahmed, G.Roopesh, M.Bandyopadhyay, M.J.Singh, Sejal Shah, A.Phukan, R.K.Yadav, N. Panda, K. Balasubramanian

A Plasma Source for High Power Microwave Interaction Studies

V.P. Anitha, Priyavandna J. Rathod, Renu Bahl, Jayesh Raval, Y.C. Saxena, Anurag Shyam, Amita Das and P.K. Kaw

Study of EMHD Waves in a Magnetic Bubble

V.P. Anitha, S.P. Banerjee, D. Sharma and S.K. Mattoo

Design, development, testing and operation of Regulated High Voltage power Supplies (RHVPS) utilized by NBI and RF heating systems for SST1

P. J. Patel, C. B. Sumod, D. P. Thakkar, L.N. Gupta, V. B. Patel, L. K. Bansal, K. Qureshi, V. Vadher, N. P. Singh, U.K. Baruah

General and Crevice Corrosion Study of the Materials for ITER Vacuum Vessel In-Wall Shield

H.A. Pathak, R.K. Dayal, V.K. Bafna, I. Kimihiro, V. Barabash

Development of & Integration of the IC H&CD System Configuration in the ITER Tokamak Complex and Auxiliary Buildings

D. Rathi, B. Beaumont, B. Arambhadiya, B. Beckett, B. Bruyere, T. Gassmann, F. Kazarian, P. Lamalle, E. Manon, T. Alonzo, U. Baruah, R. Kumar, A. Mukherjee, N.P. Singh, R. Singh, R. Trivedi, R. Goulding, R. Moon, D. Rasmussen, D. Swain, G. Agarici, L. Meunier, M. Mills, R. Sartori, J.-M. Bernard, F. Durodie, M. Nightingale, M. Shannon, D. Lockley, and ITER Organization

Multi-secondary Transformer: A Modeling Technique for Simulation

A. Patel, N.P. Singh, B. Raval, A. Roy, A. Thakar, D. Parmar, H. Dhola, R. Dave, S. Gajjar, V. Gupta, U. Baruah, V. Tripathi, L. N. Gupta, And P. Patel



Two RF Driver Based Negative Ion Source for Fusion R&D
M. Bandyopadhyay, M.J.Singh, G.Bansal, A.Gahlaut,
K.Pandya, K.G.Parmar, J.Soni, Irfan Ahmed, G.Roopesh,
C.Rotti, S.Shah, A.Phukan, R.K.Yadav and A. K. Chakraborty

International Institute of Welding, International Conference (IIW-IC-2011), Chennai 21-22 July 2011

Characterization of Electron Beam Welded SS 316L Samples
B.Ramesh Kumar, R. Gangradey

National Conference on Latest Trends in Mechanical Engineering (NCLTME-11), held at VITS, Deshmukh, Hyderabad, 6th August 2011

TIG Welding: Simulation using ANSYS
K. Pavan Kumar, Suresh Akella, B.Ramesh Kumar

14th International Conference on Ion Sources, Giardini Naxos, Italy, 11-16 September 2011

Multiple Delivery Cesium Oven System for Negative Ion Sources
G. Bansal, S. Bhartiya, K. Pandya, M. Bandyopadhyay, M. J. Singh, J. Soni, A. Gahlaut, K. G. Parmar, and A. Chakraborty

Optimization of Negative Ion Current in a Compact Microwave Driven Upper Hybrid Resonance Multicusp Plasma Source
D. Sahu, S. Bhattacharjee, M. J. Singh, M. Bandyopadhyay, and A. Chakraborty

International Workshop on Fusion for Neutrons and Sub-Critical Nuclear Fission (FUNFI-2011), Villa Monastero, Varenna, Italy, 12-15 September 2011

Indian Fusion Test Reactor
R. Srinivasan and the FTR team

22nd International Conference on Magnet Technology (MT-22), Marseille, France, 12-16, September 2011

Sub Nano-Ohm Joints in SST-1 TF Magnet Winding Packs
U. Prasad, A. N. Sharma, D. Patel, K. Doshi, Y. Khristi, P.Varmora, P. Chauhan, S. J. Jadeja, P. Gupta and S. Pradhan

Effect of Hydraulic Impedance on the Cool Down of Superconducting Magnet System of ITER
A. K. Sahu, D. Bessette, P. Bauer, A. Devred, C. Y. Gung, N. Mitchell

Cryogenic Engineering Design of the ITER Superconducting Magnet Feeders

A. K. Sahu, C. Y. Gung, K. Lu, P. Bauer, A. Devred, Y. Song, Y. Bi, I. Ilin, F. Rodriguez-Mateos, N. Dolgetta, and N. Mitchell

Design Approach and Analysis Results for Structure Feeders of ITER Magnets
A. K. Sahu, N. Dolgetta, C. Y. Gung, P. Bauer, V. Mahadevappa, K. Prasad, A. Devred, N. Clayton, and N. Mitchell

Progress in Design, Analysis, and Manufacturing Studies of the ITER Feeders
Chen-yu Gung, Yuri Ilin, Nello Dolgetta, Yonghua Chen, Pierre Bauer, Cornelis Jong, Ananta Sahu, Arnaud Devred, Neil Mitchell, Kun Lu, Yong Cheng, Zhongwei Wang, Yuntao Song, Xionyi Huang and Yangfan Bi

Key Components of the ITER Magnet Feeders
P. Bauer, Y. Chen, A. Devred, N. Dolgetta, C.Y. Gung, Y. Ilin, K. Lu, N. Mitchell, F. Rodriguez-Mateos, A.K. Sahu, Y. Song and T. Zhou

Quench characteristics of SST-1 TF Coil
A. N. Sharma, S. Pradhan, Y. Khristi, U. Prasad, J. L Duchateau

17th International Conference on Surface Modification of Materials by Ion Beams (SMIIB-2011), Harbin, China, 13-17 September 2011

Effect of Plasma Nitriding on Duplex Coated AISI M2 Steel
Partha Sakia, Alphonsa Joseph, G. Jhala, P. A. Rayjada, N. L. Chauhan, B. K. Sakia and S. Mukherjee

8th Asian European International Conference on Plasma Surface Engineering (AEPSE-2011), Dalain city, China, 19-22 September 2011

Plasma Nitriding of Welded Joints of AISI 304 Steel
Alphonsa Joseph, B.A. Padsala, S.N. Soman, G. Jhala, P.A. Rayjada, B.J. Chauhan and P. M. Raole

15th International Conference on Fusion Reactor Materials (ICFRM-15), Charleston, SC, USA, 14-22 October 2011

Plasma Aluminizing of Reduced Activation Steels
Nirav I. Jamnapara, Vishal Nayak, Dilip U. Avtani, S. Gupta, N. Vaghela, Keena Kalaria, N. L. Chauhan, S. Mukherjee, A. S. Khanna

Proceedings of Solid State Nuclear Track Detector and Their Application (SSNTD-2011), M.S University, Baroda, 16-19 October 2011

Study of fast Neutron Moderation and Shielding properties of Water and Boron Assembly

Rajnikant Makwana, Mitul Abhangi, Shailja Tiwari, Sudhirsinh Vala, Shrichand Jakhar, C V S Rao and T K Basu

Materials Science & Technology 2011 (MS&T 2011) conference, Columbus, Ohio, USA, 16-22 October 2011

Comparative Study of Aluminide Coatings on Mild Steel by Different Aluminizing Techniques

G. Awasthi, M. Mehta, D. Avtani, N. Jamnapara, G. Gupta, N. Chauhan, G. Jhala

Integrated Modeling Expert Group Annual Meeting, Cadarache, France, 24-26 October 2011

Integrated Modeling in India
N. Bisai, ITM Team.

8th General Scientific Assembly of the Asia Plasma and Fusion Association in 2011 (APFA-2011) held at Guilin, China, 1 – 4 November 2011

Nitrogen Gas Heating and Supply System for SST-1 Tokamak

Ziauddin Khan, Firozkhan Pathan, Yuvakiran Paravastu, Siju George, D. C. Raval, Gattu Ramesh, Hima Bindu, Prashant Thankey, Kalpesh Dhanani and Subrata Pradhan

Liquid Nitrogen (LN₂) Thermal Shields System in SST-1
Prabal Biswas, Kirit Vasava, Hitesh Patel, Tejas Parekh, Dashrath Sonara, Manoj Kumar Gupta, P. Yuvakiran, Siju George, Firozkhan Pathan, Ziauddin Khan, V. L. Tanna and Subrata Pradhan

Experimental studies on the effect of self-shielding of fissile fuel breeding measurement in Thorium Dioxide pellets irradiated with 14MeV neutrons

Mitul Abhangi, Nupur Jain, Rajnikant Makwana, Sudhirsinh Vala, Shrichand Jakhar, T.K.Basu and C.V.S.Rao

53rd Annual Meeting of the APS Division of Plasma Physics, Salt Lake City, Utah, 14–18 November 2011

Existence of Fluctuation Depletion Layer in Simple Magnetized Torus

Rajwinder Kaur, A.K. Singh, A. Sarada Sree, S.K. Mattoo

Propagation of Helicon Waves With Magnetic Boundaries
Anitha V P, D. Sharma, S.P. Banerjee, S.K. Mattoo and P.K. Kaw

Asian Conference on Applied Superconductivity and Cryogenics (ACASC-2011), Inter University Accelerator Center (IUAC), New Delhi, India, 16 – 18 November 2011

Performance Validation Tests on 80 K Bubble types of Shields for SST-1

Dashrath Sonara, Vipul Tanna, Rohit Panchal, Nitin Bairagi, Manoj Kumar Gupta, Naresh Chand Gupta, Ketan Patel, Hiren Nimavat, Rajiv Sharma, Ziauddin Khan, Firoz Khan, P Yuvakiran, Siju George, Dilip Raval, Tejas Parekh, Aashoo Sharma and Subrata Pradhan

Overall Vacuum Experience during Cold Campaign
Ziauddin Khan, Dilip C. Raval, Kalpesh R. Dhanani, Firozkhan Pathan, Prashant Thankey, Siju George, P. Yuvakiran, Hima Bindu, Gattu Ramesh and Subrata Pradhan

Integrated Leak Testing of 80 K Thermal Shields of SST-1 in RT and Cold Condition

Firozkhan Pathan, Ziauddin Khan, P. Yuvakiran, Siju George, Dilip C. Raval, Prashant Thankey, Kalpesh R. Dhanani, Hima Bindu, Gattu Ramesh, Manoj Kumar Gupta, Dashrath Sonara, Ketan Patel, H. Nimavat, Srikant, V. L. Tanna, A N Sharma, Tejas Parekh, P. Biswas, Hitesh Patel and Subrata Pradhan

Quality Assurance and Quality control for SST-1 Magnet System

Pratibha Gupta, Upendra Prasad, A.N.Sharma, S.J.Jadeja and S.Pradhan

Progress of SST-1 superconducting magnets and associated sub-systems

A.N.Sharma, Upendra Prasad, S.Pradhan, K.Doshi, P.Varmora, Y.Khristi, D.Patel, S.J.Jadeja, P.Gupta

Technological advances in superconducting magnet system of SST-1

Upendra Prasad, Ashoo.N.Sharma, Dipak Patel, Kalpesh Doshi, Pankaj Varmora, Yohan Khristi, Pradeep Chauhan, Surendra.J.Jadeja, Pratibha Gupta and Subrat Pradhan

Operation and Control Strategies in Pre-Series Testing of Cold Circulating Pumps for ITER

R. Bhattacharya, H. Vaghela, B. Sarkar, M. Srinivas and Choukekar K.

Design Approach for a Cryogenic Distribution Box of Large Scale Fusion Machine with

Superconducting Magnets
Hitensinh Vaghela, Biswanath Sarkar, Ritendra Bhattacharya, Ketan Choukekar and Himanshu Kapoor

Detailed Design Aspects of Cryoline 'MAG - CL' for a Fusion Reactor

S. Badgajar, H. Naik and Sarkar B

Design Optimization of Heat Exchanger used in Cryopump Cooling Circuit for a Typical Fusion Machine: A Parametric Study



Nitin Shah, Biswanath Sarkar, and Hemant Naik
Proceedings of Conference on Accelerator Radiation Safety
(CAR-2011), BARC, Mumbai, 16-18 November 2011

Shielding Design of the proposed laboratory for an intense 14
MeV neutron Generator
Rajnikant Makwana, Sudhirsinh Vala, Mitul Abhangi,
Shrichand Jakhar, C.V.S. Rao and T.K.Basu

***National Symposium on Acoustics, NSA-2011 at Bun-
delkhand University, Jhansi, 17-19 November 2011***

Acoustic Emission Technique applications for nuclear reac-
tor materials research: Brief Review
S.V. Ranganayakulu, B.Ramesh Kumar

***International Conference on Plasma Processing of Organic
Materials and Polymers (PPOMP-2011), Mahatma Gandhi
University, Kottayam, Kerala, 24-28 November 2011***

Laboratory Study of Lithium Coating for Tokamak Aditya
P. A. Rayjada, B. K. Das, S. B. Bhatt, Manoj Kumar and Ajai
Kumar

***2nd International Conference Frontiers in Diagnostic
Technologies, at Istituto Nazionale di Fisica Nucleare
(INFN), Frascati, Italy, 28th - 30th November 2011***

A passive Charge Exchange Diagnostics at Aditya Tokamak
for Ion Temperature Estimation using Electrostatic Parallel
Plate Analyzer
Kumar Ajay, Santosh P. Pandya, Priyanka Mishra, Rajani D.
Dhingra and J. Govindarajan

***21st International Toki Conference (ITC-21) on Integra-
tion of Fusion Science and Technology for Steady State Op-
eration, Ceratopia Toki, Toki-City, Gifu, Japan., November
28 -December 1, 2011***

Design and Development of Infrared Imaging Video Bolom-
eter for ADITYA Tokamak
Santosh P. Pandya, Shwetang N. Pandya and J. Govindarajan.

***11th Annual conference of Indian Society of hospital waste
management, M. S. Ramaiah College, Bangalore, 2-4 De-
cember 2011***

Safe disposal of Bio-Medical Waste using Plasma Pyrolysis
Technology
P. Vadivel Murugan

***International Conference on Microwaves, Antenna, Propa-
gation and Remote Sensing (ICMARS-11), Jodhpur, 7-10
December 2011***

Virtual Cathode Based High Power VIRCATOR Characteri-
sation
Renu Bahl, Rajesh Kumar, Anitha V P, Sanjay Kulkarni, Y.C.
Saxena and Chenna Reddy

***9th International Symposium on Surface Protective Coat-
ing (SSPC 2011-12) and Indo-German Conference on Sur-
face Engineering, Bangalore, 7-9 December 2011***

Comparative Study of Plasma Oxidation and Thermal Oxida-
tion of Aluminized 9Cr-1Mo Steels
Nirav I Jamnapara, Dilip U. Avtani, N. L. Chauhan, S. B.
Gupta, Keena Kalaria, Naresh Vaghela, S. Mukherjee and A.
S. Khanna

***Proceedings of the National Seminar & Exhibition on Non-
Destructive Evaluation (NDE 2011), Chennai, December
8-10, 2011***

Transient Infrared Thermography of Brazed Divertor Test
Mockups before and After High Heat Flux Test
Yashashri Patil, Santosh P. Pandya, S. Tripathi, M. S. Khan,
S. S. Khirwadkar and J. Govindarajan

Weld Quality Analysis of Tig, Laser and Electron Beam
Welded SS 304 and 316 Materials with NDT Techniques
B. Ramesh Kumar

***3rd International Conference on Current Developments in
Atomic, Molecular, Optical & Nano Physics (CDAMOP)
2011, University of Delhi, Delhi, 14-16 December 2011***

Enhanced collisionless absorption in a cluster with extreme
few-cycle laser light
M. Kundu and P. K. Kaw

***National Welding Seminar (NWS-2011), Bhilai Steel Plant
City, 15-17 December 2011***

SMAW, Process Parameter Optimization with Taguchi meth-
od of experimentation
Y.Harinath, M. Venkatramana, Suresh Akella, Ramesh Ku-
mar Buddu

***26th National Symposium on Plasma Science and Technol-
ogy (PLASMA – 2011) held at Birla Institute of Technology
Mesra, Patna, 20–23 December 2011***

Negative ion production using Caesium coated dust
B.Kakati, S.S.Kausik, B.K.Saikia, M.Bandyopadhyay and
P.K.Kaw (Buti Award)
Laser interaction with nano-cluster in the few-cycle regime
M. Kundu and P. K. Kaw (Best Poster Award)

Relativistic electromagnetic flat top solitons in cold plasmas
Sita Sundar, Amita Das, Vikrant Saxena, Predhiman Kaw and
Abhijit Sen

- Mass Flow Requirement for SST-1 Vacuum Vessel and PFC Components Baking
Yuvakiran Paravastu, Ziauddin Khan, Firozkhan Pathan, Siju George, Dilip C. Raval, Gattu Ramesh, Himabindu M., Prashant Thankey, Pratibha Semwal, Kalpesh Dhanani and Subrata Pradhan
- First Calibration Results of Time of Flight Low Energy Analyzer for Neutrals from Aditya Tokamak
Kumar Ajay, Santosh P. Pandya, Snehlata Gupta, Priyanka Mishra, Hitesh Mandaliya and J. Govindarajan
- Scheme of Detection and Data Acquisition for Time of Flight Signal with Parametric Optimization for Energy Resolution
Snehlata Gupta, Santosh P. Pandya, Kumar Ajay, Priyanka Mishra, Hitesh Mandaliya, Chhaya Chavda and J. Govindarajan
- Simulation and Experimental Analysis of the Heat Pipe Oven for Photo-Ionized Lithium Plasma Source for Plasma Wake-field Accelerator Experiment
Martand Pandagale, Kanchan Mahavar, K. K. Mohandas, Ajai Kumar, D. Chenna Reddy and Ravi A. V. Kumar
- Initial results from modeling irradiation damage in fusion reactor materials
M. Warriar, C. Danani, S. Chaturvedi
- A RF Compensated Langmuir probe for Inductively Coupled RF Plasma
A. Phukan, K. Barada, P.K. Chattopadhyay, M. Bandyopadhyay
- Dependence of Plasma Parameter Variation on Filament Position and Transverse Magnetic Field Strength
B.K. Das, M. Chakraborty, M. Bandyopadhyay
- Fast Imaging of Plasma Blob Motion across Non-Uniform Magnetic Field
G. Sahoo, S. Samantaray, R. Paikaray, D.C. Patra, N. Sasini, M.B. Chowdhury, J. Ghosh, A.K. Sanyasi
- High Voltage Electronics for Non-Neutral Plasma Experiment
Minsha Shah, Hitesh Mandliya, Rachana Rajpal, P.K. Chattopadhyay, Chenna Reddy, Karan and Sambharan Pahari
- Negative Ion Production using Cesium Coated Dust
B. Kakati, S.S. Kaushik, B.K. Saikia, M. Bandyopadhyay and P.K. Kaw
- Conceptual Thermal Hydraulic Studies of a MW class Gyrotron Collector
Tarun Kumar Sharma
- RF Generator for Negative Ion Source of ITER-DNB
Sandip Gajjar, U K Baruah, N P Singh, M. Bandopadhyay, M J Singh, H. Decamps, D. Lathi, A Thakar, B Raval, A K Roy, A. Patel, D Parmar, H Dhola, R Dave and V Gupta
- Excitation of Electrostatic Waves using Pulsed Capacitive Process
Satyananda Kar and Subroto Mukherjee
- Dust Crystallization in Magnetized Strongly Coupled Plasma
Saurav Bhattacharjee, Swati Baruah, Nilakshi Das
- A Magnetized Constricted Hollow Anode Plasma Source for Plasma Surface Interaction Studies
Soumen Ghosh, Shantanu Kumar Kankari
- Study of Electron Temperature Gradient Turbulence in Finite Beta Plasma
S.K. Singh, L.M. Awasthi, S.K. Mattoo, R. Singh and P.K. Kaw
- Scaling of Electron Temperature Gradient with EEf for ETG Turbulence Study
S.K. Singh, L.M. Awasthi, p.k. Srivastava, S.K. Mattoo, R. Singh and P.K. Kaw
- Characteristics of a Low Beta (β) Plasma Sandwiched between High Beta Plasma
A.K. Sanyasi, L.M. Awasthi, S.K. Mattoo, S.K. Singh, P.K. Srivastava, R. Singh
- Turbulence in the Transition Region of Extremely Low to High Beta Plasma
A.K. Sanyasi, L.M. Awasthi, S.K. Mattoo, S.K. Singh, P.K. Srivastava, R. Singh and P.K. Kaw.
- A Novel Diagnostic for Predicting State of Electron Emission from a Heated Filament
P.K. Srivastava, L.M. Awasthi, and S.K. Mattoo
- Scavenging of Energetic Electron through Active Discharge Voltage Control in Lvpd
P.K. Srivastava, Arvind Chavda, L.M. Awasthi and S.K. Mattoo.
- Pulsed Power Supply for Electron Energy Filter for LVPD
P.K. Srivastava, S.K. Singh, L.M. Awasthi, and S.K. Mattoo.
- Filtered Bolometer Camera for ADITYA Tokamak
Prabhat Kumar, Kumudni Tahiliani, M.V. Gopalakrishna and Ratneshwar Jha
- Advanced Facility for Calibration of AXUV Photodiodes using VUV Source
Prabhat Kumar, Kumudni Tahiliani, Ratneshwar Jha, M.V. Gopalakrishna.



Auxiliary Systems for Negative Ion Source Experimental Facility at IPR

K.Pandya, G.Bansal, J.Soni, M.Bandyopadhyay, M.J.Singh, R.K.Yadav, A.Gahlaut, K.G.Parmar, A.Chakraborty

Current Free double Layer Study in Expanding Helicon Plasma Experiment

Kshitish Barada, Prabal Chattopadhyay, J Ghosh, D.Sharma, Sunil Kumar, Y.C Saxena

A Novel Infinite Series Expensiodie/Non-Periodie 3D Real Vector Function for Modeling Nonlinear Dynamics and Waves

A.K.Agarwal

Vlasov Simulation of Time – Evolutionary Plasma Sheath

K.Saharia and K.S.Goswami

Least Square Fitting to Estimate the Plasma Parameters Simultaneously From Spectroscopic Data Observations

Jalaj Jain, Ram Prakash, Gheesa Lal Vyas, Pavindra Kumar, Yaduvendra Choyal, Malay Bikas Choudhary and Ranjana Manchanda

Coolong Water System for ICH & CD Lab.

P.Singh, S.K.Sharma, M.Vasani, Y.Trivedi and D.Chenna Reddy

An Axial Vircator Based on Compact Tesla Generator

Rajesh Kumar, Jignesh Patel, and Anurag Shyam

Negative Ion Production using Cesium Coated Dust

B.Kakati, S.S.Kausik, B.K.Saikia and M.Bandyopadhyay

Plasma Pyrolysis of Crude Oil Residue

C.Patil, V.K.Shrivastav, Kaushik, A.Sanghariyat, B.K.Patel, P.V.Murugan, S.K.Nema

Estimation of Nitrogen Concentration in the Diffusion Zone for Plasma Nitrided Steels

Ravindra Kumar, Jalal Jain, Gheesa Lal Vyas, S.Konar, S.Mukherjee, Ram Prakash

Ion Acceleration by Circularly Polarized Laser Pulses in Thick Targets

Ujjwal Sinha and Predhiman K. Kaw

Large Amplitude upper hybrid oscillations in presence of inhomogeneous magnetic field

Chandan Maity, Nikhil Chakrabarti and Sudip Sengupta

Shock Wave Analysis and Bubble Dynamics of plasma Produced in Liquid Phase Pulsed Laser Ablation on a Target using Beam Deflection Setup

S.SasankaKumar, M.K.Jayaraj, Ajai Kumar, Ravi.A.V.Kumar.

Structure formation in expanding barium plasma plume in high background pressure

Manoj Kumar, R.K.Singh and Ajai Kumar.

Dielectric breakdown study under pulsed power conditions

G.Veda Prakash, R.Kumar, C.Reddy, A.Shyam and J.Patel

An update on quality assurance and quality control for SST-1 magnet system

Pratibha Gupta, Upendra Prasad, A.N. Sharma, S.J.Jadeja and S.Pradhan

Application of non-destructive evaluation techniques for CFC/Cu and W/Cu brazed joints for Divertor Target elements

M.S.Khan, S.S.Khirwadkar, Santosh Pandya, Yashashri Patil, K.P.Singh, J.Govindrajn

Calorimetry on Beam Line Components of SST-1 NBI Test Stand

P.M.Jayedevan, P.Bharathi, V.Prahlad, S.K.Suraj, K.Qureshi, L.K.Bansal and U.Barua

Conceptual Design of Calorimeter Motion Mechanism for DNB

Irfan Ahmed, G.Roopesh, M.Bandyopadhyay, M.J.Singh, C.Rotti, S.Shah, R.Prasad, H Patel, S. Pillai, J Joshi, A.Phukan, R.K.Yadav and A.K.Chakraborty

Neutral Beam Injection Systems: An Engineering Persepective

U. K. Baruah and NBI Group

Vibration Effects Assesment of ITER Port Plug

S. Padasalgi, S. Kumar and P. Vasu

Condition accessment of high voltage equipments through capacitance & tan delta measurment at substation

Chandra Kishor Gupta and SST-1 Power System Division

DAC System software for 91.2 mhz 1.5 mw ICRH system for SST 1.

Ramesh Joshi, H.M.Yadav, Manoj Parihar, B.R.Kadia, K.M.Parmar, A Varia, K.Misra, Y S S Srinivas, R.A.Yogi, A.Gayatri, Raj Singh, Sunil Kumar & S.V.Kulkarni

Data acquisition system for robin

R.K.Yadav, J.Soni, A.Gahlaut, K.G.Parmar, D.Macwan, K.Patel, G.Bansal, K.Pandya, M. Bandyopadhyay, M.J. Singh and A.Chakraborty.

Design and Development of Four Channels Fast Counter for Charge Exchange Diagnostic

N.C.Patel, Chhaya Chavda, Kumar Ajay, Prabal Chattopadhyay

Design Aspect of the Tandem 3-db Hybrid Coupler using Matching Stub for RF Heating of Plasma in Tokamak
Rana Pratap Yadav, Sunil Kumar and S.V.Kulkarni

Design Development and commissioning of – 60kv dc power supply for standalone testing of amps
Saifali Dalakoto, N.Rajan Babu and P.K.Sharma

Design of a Hydrogen Isotopes Sensor for Liquid Lead-Lithium Eutectic
Amit Sircar, Rudreksh B.Patel, P.A.Rayjada, V.Gayatri Devi, S.K.Sharma, Vivek Dave

Design of high power soda water RF dummy load
Harsha Machchhar, JVS Krishna, R.G.Trivedi, Raghuraj Singh, Kumar Rajnish, Ajesh P., Gajendra Suthar, Dipal Soni, Manoj Patel, Aparajita Mukherjee

Design Development and testing of fiber optics link for transmission of high frequency analog signal
Jignesh Soni, R.K.Yadav, D.Macwan, A.Gahlaut, K.G.parmar, K.Patel, G.Bansal, K.Pandya, M. Banyopadhyay, M.J.Singh and A.Chakraborty.

Development of auxiliary power supplies for pre-driver amplifier of ITER R&D source
Gajendra Suthar, Aparajita Mukherjee, R.G.Trivedi, Kumar Rajnish, Raghuraj Singh, Harsha Machchhar, Ajesh P., Dipal Soni, Manoj Patel, Ajesh P., JVS Hari Krishna

Development of interlock system for R&D source
Kumar Rajnish, Dipal Soni, Raghuraj Singh, Manoj A Patel, R.G Trivedi, Harsha Machchhar, Gajendra Suthar, P.Ajesh, Aparajita Mukherjee, Keyur Makadia, Jirav Fadia

Development of Labview based graphical user interface for SST-1 CAMAC data acquisition system integrated operation with central control system
Imran Mansuri, Amit Kumar Srivastava, Tushar Raval, Atish Sharma and Subrata Pradhan.

Development of pre-driver amplifier for ITER Ion Cyclotron System
Raghuraj Singh, Aparajita Mukherjee, R.G Trivedi, Kumar Rajnish, Harsha Machchhar, Ajesh P., Gajendra Suthar, Dipal Soni, Manoj Patel, JVS Hari Krishna.

Electrical power supply system for 42 GHz, 200KW CW Gyrotron
N.Rajan Banu, Jigalraj Vansia, S.V.Kulkarni.

Electrode biasing experiment in Aditya Tokamak
Pravesh Dhyani, J.Ghosh, P.K.Chattopadhyay, K.Sathyanarayana, K.A.Jadeja, Debjyoti Basu, R.L.Tanna, Amit Prajapati, S.B.Bhatt, D.S.Varia, M.B.Kalal, Jayesh

Raval, Shankar Joisa, Nilam Ramaiya, M.B.Chowdhuri, Aniruddh Mali, Umesh Dhobi, P.K.Atrey, Kumudni, Tahiliani, C.N.Gupta Y.C.Saxena and ADITYA Team.

Embedded Data Acquisition System using MDSplus for Aditya Tokamak
Jigneshkumar J Patel, Rachana Rajpal, Praveena kumari, P.K.Chattopadhyay, Y.C.Saxena

Half Bridge Resonant Converter and its applications in Plasma
A.Visani, S.Patel, D.Gaur, V.Jain

Heat Propagation during ELM Crash at DIII-D Tokamak Discharges
Y Shankara Joisa, Eric Hollomann, M.E.Austin

Heating and Bias Power Supply System (HBPS) for Negative Ion Source at IPR
K.G.Parmar, A.Gahlaut, J.Soni, G.Bansal, K.Pandya, M.J.Singh, M.Bandyopadhyay, R.K.Yadav, and A.Chakraborty.

Interface for RHVPS with 82.6 GHz Gyrotron based ECRH DAC system in SST 1
Jatin Kumar patel, Harshita Patel, Pragnesh Dhorajjiya, N.Rajanbabu, K.Sathyanarayan, B.K.Shukla and ECRH Group

LOCA and LOFA analysis for Indian LLCB TBM for ITER
Paritosh Chaudhuri, Vilas Chudhari, and Chandan Danani

Measurement of the Deuterium Ion Beam Profile for the 14-MeV Neutron Generator
Sudhirsinh Vala, Mitul Abhangi, Rajnikant Makwana, CVS Rao and T.K.Basu.

Mechanical analysis of coaxial cavity for driver stage amplifier in MHz frequency range
P Ajesh, Raghuraj Singh, Aparajita Mukherjee, Gajendra Suthar, R.G.Trivedi, Kumar Rajnish, Harsha Machchhar, Dipal Soni, Manoj Patel, JVS Hari Krishna.
Overview of Plasma operations in Aditya tokamak
R.L.Tanna, S.B.Bhatt, C.N.Gupta, Chhaya Chavda, V.K.Panchal, K.A.Jadeja, Kunal Shah, Y.S.Joisa, P.K.Atrey, Kishore Mishra, S.V.Kulkarni, Kumar Ajay, J.Govind Rajan, Deepak Sangwan, R.Jha, Pravesh Dhyani, D.Raju, J.Ghosh, P.K.Chattopadhyay.

R&D plan and strategies for ITER radio frequency power sources package
Aparajita Mukherjee, R.G.Trivedi, Raghuraj Singh, Kumar Rajnish, Harsha Machchhar, Ajesh P., Gajendra Suthar, Dipal Soni, Manoj Patel, JVS Hari Krishna.



Realization of RF monitoring & control for radio frequency power sources

Manoj Patel, R.G.Trivedi, Kumar Rajnish, Raghuraj Singh, Harsha Machchhar, Ajesh P., JVS Hari Krishna, Gajendra Suthar, Dipal Soni, Aparajita Mukherjee.

Recombination phenomena in plasma Blob Produced by Washer Stacked Plasma Gun

N.C.Sasini, R.Paikaray, G.Sahoo, D.C.Patra, S.Samatray, J.Ghosh, A.Sanyasi.

Role of Reynolds Stress and its Divergence in the Intrinsic Flow Generation in the ADITYA Tokamak

J.Brotankova, D.Sangwan, R.Jha

Setting up a pulse forming network (pfn) for feeding high frequency pulsed power to different configurations of washer plasma gun

S.Samantaray, G.Sahoo, D.C.Patra, R.Paikaray, N.Sasini, A.Mishra, J.Ghosh, A.K.Sanya

Structural and Surface Morphological Changes on Tungsten due to Ion Irradiation

M.Bhuyan, S.R.Mohanty, C.V.S.Rao, P.A.Rayjada and P.M.Raole.

Study and Simulation for Compensation of Cathode Cooling Effect in high power Gyrotron

Gaurav Joshi, S.L.Rao, Anjali Sharma, Mahesh Kushwah, Vipal Rathod, Ronak Shah and Deepak Mandge

Minimization of Voltage Probes using Numerical Techniques for VSWR Curve Interpolation at ICRF

Raj Singh, Atul Varia, Bhavesh Kadia, Kirit Parmar, H.M. Jadav, Manoj Parihar, Sunil Kumar, Kishore Mishra, Y.S.S. Srinivas, Ramesh Joshi and S.V. Kulkarni

Test Results of Loop Type Directional Coupler for ICRF Heating at 45.6 MHz.

Raj Singh, Atul Varia, Bhavesh Kadia, Kirit Parmar, H.M. Jadav, Manoj Parihar, Sunil Kumar, Kishore Mishra, Y.S.S. Srinivas, Ramesh Joshi and S.V. Kulkarni

Up-Gradation and Revamping of SCADA System for SST-1 Water Cooling System

M.Vasani, P.Singh, S.K.Sharma, Y.Trivedi and D.Chenna Reddy.

Upgradation of Data Visualization Software for ADITYA Discharge Data Acquired using PXI System

V.K.Panchal, Abhijeet Kumar, Chhaya Chavda, P.K.Chattopadhyay & ADITYA Team.

Vibration effects assessment of ITER port plug

S.Padasalgi, S.Kumar, P.Vasu.

Java based real time data acquisition and control client software for SST-1 RF ICRH system

Ramesh Joshi, H.M.Jadav, Manoj Parihar, B.R.Kadia, K.M.Parmar, A.Varia, K.Mishra, Y.S.S.Srinivas, R.A.Yogi, A.Gayatri, Raj Singh, Sunil Kumar & S.V.Kulkarni.

Recent results on Plasma Position Feed Back Control in ADITYA Tokamak

C.N.Gupta, R.L.Tanna, D.Raju, R.Jha & Aditya team

GPS based time synchronization system for SST-1

Aveg Kumar, Harish Masand, Manisha Bhandarkar, Jasraj Dhongde, Kirit Patel, Hitesh Chudasama and S.Pradhan.

Upgradation of central control system (CCS) of SST-1

Harish Masand, Manisha Bhandarkar, Aveg Kumar, Kirit Patel, Jasraj Dhongde, Hitesh Chudasama and S.Pradhan.

Design and analysis of double layered rectangular bellow

Avik Bhattacharya, Vipul More, Girish Gupta, Gaurav Jogi, Anil Bhardwaj.

Structural & Thermal Analysis of ITER-TCPH

Gaurav Joshi, Girish Gupta, Vipul More, Avik Bhattacharya, Anil Bhardwaj.

Cryostat Base section Pedestal Column design

Mukesh Kumar Jindal, Girish Gupta, Vipul More, Avik Bhattacharya, Vaibhav Joshi, Anil Bhardwaj.

Modified design of existing Trigger Module for Series Ignitron Crowbar System of ITER-India Gyrotron Test Facility (IIGTF)

Mahesh Kushwah, Gaurav Joshi, Vipal Rathod, S.L.Rao, Ronak Shah, Anjali Sharma and Deepak Mandge.

Simulation Study of Solid State Crowbar System for Body Power Supply (BPS) of ITER-India Gyrotron Test Facility (IIGTF)

Mahesh Kushwah, Gaurav Joshi, Ronak Shah, S.L.Rao, Vipul Rathod, Anjali Sharma and Deepak Mangde

Study of polarization changes on reflection from corner cube retroreflector for fir interferometer in SST-1 TOKAMAK

P.K.Mishra, R.Kaur, A.Adhiya.

Calorimetry on Beam Line Components of SST-1 NBI Test Stand

P.M.Jayadevan, P.Bharathi, V.Prahlad, S.K.Suraj, K.Qureshi, L.K.Bansal and U.Baruah

Recent technologies for superconducting magnets of SST-1
Uendra Prasad, A.N.Sharma, Dipak Patel, K.Doshi, Y.Khristi, P.Varmora, P.Chauhan, S.J.Jadeja, P.Gupta and S.Pradhan

Structural and electrical properties of Lithium Metatitanate
Umasankar Dash, Kajal Parashar, Paritosh Chaudhuri, B.S.Murty, S.K.S.Parashar

SST-1 Magnet Data Acquisition System

K.Doshi, H.Masand, Y.Khristi, A.Sharma, U.Prasad, S.Kedia, S.Pradhan

Langmuir a RF Compensated probe for Inductively Coupled RF Plasma

A.Phukan, K.Barada, P.K.Chattopadhyay, M.Bandyopadhyay

A Fast Scanning Langmuir Probe Drive for SST-1 Tokamak
Prabhat Kumar, Ratneshwar Jha, M.V.Gopalakrishna

Application of RGA as Leak Detector in ADITYA Tokamak Vacuum System

K.A.Jadeja, S.B.Bhatt.

Experimental Study and Comparison of the Thermal Sensitivity of Different Thin Metal Foil to be used as Broad Band Radiation Absorbing Element in Infrared Imaging Bolometer
Zubin Shaikh, Santosh P. Pandya, Shamsuddin Shaikh and J. Govindarajan

Failure Mode and Effect Analysis (FMEA) for Diagnostic Neutral Beam Power Supply (DNBPS) System of Iter

Rasesh Dave, Aruna Thakar, N.P.Singh, Hitesh Dhola, Bhavin Raval, Amit Patel, Darshan Parmar, Sandip Gajjar, Arpit Roy, Vikrant Gupta, U.K.Baruah.

Half Bridge Resonant Converter and its applications in Plasma

A.Visani, S.Patel, D.Gaur, V.Jain

Infrared thermographic observation of Aditya Tokamak Limiter

Santosh P.Pandya, Shwetang N.Pandya, K.A.Jadeja, Shamsuddin Shaikh, Praveen Malav, Nilam Ramaiya, R.Manichanda, M.B.Chowdhuri, S.Banerjee, Joydeep Ghosh, S.B.Bhatt, Raju Denial, J.Govindarajan, R.L.Tanna, R.Jha, P.K.Chattopadhyay and ADITYA Team.

Propagation of Far Infrared Radiation for Interferometry Diagnostics for SST-1 Tokamak

Asha Adhiya and Rajwinder Kaur

Studies of vertical asymmetries in spectral line emissions in the aditya tokamak

Nilam Ramaiya, R.Manichanda, M.B.Chowdhuri, Anirudh Mali, Niral Chanchapara, Payal Mehta, S.Banerjee and J.Ghosh

Characterization of Penning Plasma Discharge Source

Gheesa Lal Vyas, Jalal Jain, Ravindra Kumar, Malay Bikes Choudhary, Ranjana Manichanda and Ram Prakash

Investigation of Arcing phenomena on Satellite Solar Array surface

Venkatesh S, Suryakant Gupta, Subroto Mukherjee, Keena Kalaria, Naresh Vaghela, Hiren Bhatt

Radial drift velocity of atmospheric gas plasma blob across non – uniform magnetic field

D.C.Patra, G.Sahoo, S.Samantaray, R.Paikaray, N.Sasini, J.Ghosh, A.K.Sanyasi

Polarization Properties of Metal Reflector using Mueller Calculus

Asha Adhiya, Rajwinder Kaur and Pabitra Kumar Mishra

Studies on Soft X-Ray Emission from Plasma Focus Device with Three Different Shaped Anodes

N. Talukdar, N.K. Neog and T.K. Borthakur

Simulation of Welding Process: A Finite Element Approach to Analyze

S. Akella, B. Ramesh Kumar

Conceptual Design of Analog 300KV Isolation I/O Transceiver to Control Accelerator Based 14-MeV Neutron Generator

E.V. Praveenlal, Hitesh Mandaliya, Rachana Rajpal, P.K. Chattopadhyay, SudhirsinhVala, C V S Rao and T.K.Basu

International Symposium on Joining of Materials (SO-JOM- 2012) held at WRI, Tiruchirapalli, 19-21 January 2012

Mechanical Properties Charatcerization of TIG welded SS 316 Samples for Fusion Reactor Relavent Applications

B. Ramesh Kumar

Engineering Coating, Process, Control and Applications, ENGGCOAT-2012, IIT Mumbai, 9-11 February 2012

Comparision of Corrosion Properties of SS410 and SS304 Steel by Plasma Nitrocarburising Process

Alphonsa Joseph



International Conference on Advanced Polymeric Materials, CIPET, Bhubaneswar, 10-12 February 2012

Synthesis of Syn gas and Precursors from Polymeric Waste using Plasma Pyrolysis Technology

P. Vadivel Murugan, S. K. Nema

International Symposium on Vacuum Science & Technology and its Application for Accelerators (IVS – 2012) held at VECC-SINP Campus, Kolkata, India, 15–17 February 2012

Development of Programmable Pulse Generator for ADITYA Gas Puffing System

Narendra Patel, Chhaya Chavda, Shailesh Bhatt, PrabalChat-topadhyay, Y. C. Saxena, ADITYA Team

Challenge – Large and Long Ultra High Vacuum System for LIGO-India

Ajai Kumar, Shailesh Bhatt, S. K. Shukla, C. S. Unnikrishnan, Consortium Indigo

Baking of SST-1 Vacuum Vessel Modules and Sectors

Firoz khan S Pathan, Ziauddin Khan, Paravastu Yuvakiran, Siju George, Gattu Ramesh, Himabindu Manthena, Virendrakumar Shah, Dilip C Raval, Prashant L Thankey, Kalpesh R Dhanani and Subrata Pradhan.

Baking of Inboard Poloidal Limiter for SST-1 Tokamak

Yuvakiran Paravastu, Firozkhan S. Pathan, Ramesh Gattu, Siju George, Kalpesh R. Dhanani, PratibhaSemwal, Virendrakumar Shah, Himabindu Manthena, Dilip C. Raval, Ziauddin Khan, Subrata Pradhan

SST-1 Gas Feed and Gas Exhaust System

Dilip C Raval, Ziauddin Khan, Prashant L Thankey, Kalpesh R Dhanani, Firozkhan S Pathan, Pratibha Semwal, Siju George, Paravastu Yuvakiran, Himabindu Manthena and Subrata Pradhan

General and Crevice Corrosion Study of the In -Wall Shielding Materials of Vacuum Vessel of ITER

K. Joshi, H. Pathak, R. Dayal, V. Bafna, I. Kimihiro, V. Barabash

Influence of Wall Conditioning on ADITYA Plasma Discharges

R.L. Tanna, K.A. Jadeja, S.B. Bhatt, P.S. Bawankar, Y.S. Jaisa, P.K. Atrey, R. Manchanda, Nilam Ramaiya, J. Ghosh, P.K. Chattopadhyay and ADITYA team

Vacuum Aspects of ITER Diagnostic Systems

Kaushal Patel, Victor Udintsev, Chris Walker, Shaun Hugh-

es, Direz Marie-France, Anna Encheva, Alessandro Tesini, Christopher Watts, George Vayakis, Luciano Bertalot, Michael Portales, Michael Walsh , Neill Taylor, Phillip Andrew, Philippe Maquet, Robin Bansley, Roger Reichle, Robert Pearce, Spencer Pitcher

Conceptual Design of Vacuum Chamber for Testing of High Heat Flux Components using Electron Beam as a Source

M.S.Khan, Rajamannar Swamy, S.S.Khirwadkar and Prototype Divertors Division

Thick SS316 Materials TIG Welding Development Activities towards Advanced Fusion Reactor Vacuum Vessel Applications

Ramesh Kumar Buddu, R. Gangradey

Study of Residual Gas Analyser (RGA) Response towards Known Leaks

Firozkhan S. Pathan, Ziauddin Khan, PratibhaSemwal, Siju George, Dilip C. Raval, Prashant L. Thankey, Kalpesh R. Dhanani, YuvakiranParavastu, Himabindu Manthena, Ramesh Gattu

Spinning Rotor Gauge Based Vacuum Gauge Calibration System at the Institute for Plasma Research (IPR)

PratibhaSemwal, Ziauddin Khan, Kalpesh R. Dhanani, Firozkhan S. Pathan, Siju George, Dilip C. Raval, Prashant L. Thankey, YuvakiranParavastu, Himabindu Manthena, Ramesh Gattu

Study of Hydrogen Pumping through Condensed Argon in Cryogenic pump

K. A. Jadeja, S. B. Bhatt

High-vacuum Compatibility Tests of SST-1 Superconducting Magnets

Prashant L Thankey, Ziauddin Khan, Siju George, Firozkhan Pathan, Kalpesh R Dhanani, Yuvakiran Paravastu, Himabindu Manthena, Dilip C Raval and Subrata Pradhan

PXI Based Vacuum Control for Testing Various Components of SST-1

Kalpesh R. Dhanani, Ziauddin Khan, Dilip C. Raval, Prashant L. Thankey, Firozkhan S. Pathan, Siju George, Yuvakiran Paravastu, Pratibha Semwal, Himabindu Manthena, Ramesh Gattu

Out-Gassing Measurement of G-10 Grade Material at Different Temperature

Siju George, Firozkhan S. Pathan, Prashant L. Thankey, PratibhaSemwal, Kalpesh R. Dhanani, Dilip C. Raval, YuvakiranParavastu, HimabinduManthena, Ramesh Gattu, Ziauddin Khan

Development of High Vacuum Facility for Baking and Cool Down Experiments for SST-1 Tokamak Components
Ziauddin Khan, Firozkhan S Pathan, Paravastu Yuvakiran, Siju George, Himabindu Manthena, Dilip C Raval, Prashant L Thankey, Kalpesh R Dhanani, Manoj Kumar Gupta and Subrata Pradhan

Thermo-Mechanical Induced Deformation Simulation Studies for Metal Gaskets for UHV Application
Ramesh Kumar Buddu, Shishir Purohit

Effect of Titanium Sublimation Pump in Turbo Molecular Pumped Vacuum System
K. A. Jadeja, M. B. Kalal, T. P. Purabia, P.M. Chavda, S. B. Bhatt

Indigenous Development of Single Barrel Hydrogen Pellet Injector System
Ranjana Gangradey, Ravi Prakash, Samiran Mukherjee, Paresh Panchal, Pramit Dutta, Naveen Rastogi

Development and Characterization of Tungsten Coating on Graphite at IPR
P A Rayjada, K. A. Jadeja, N. L. Chauhan, N. P. Vaghela, S. B. Bhatt, P M Raole and Ajai Kumar

Experience with Helium Leak and Thermal Shocks test of SST-1 Cryo Components
Rajiv Sharma, Hiren Nimawat, G L N Srikanth, Nitin Bairagi, Vipul Tanna, Subrata Pradhan

Studies Carried Out towards Development of Indigenous Cryoadsorption Cryopump
Ranjana Gangradey, Ravi Prakash,

Up-Gradation of UHV System of SMARTEX-C
Lavkesh Lachhvani, Pahari Sambaran, Y. C. Saxena

Development and Testing of Ultra High Vacuum System for Time of Flight Neutral Particle Energy Analyzer
Priyanka Mishra, Santosh P. Pandya, Kumar Ajay, Snehlata Gupta and J. Govindarajan

2nd Indo-US Workshop on Magnetic Fusion Research, Institute for Plasma Research, Ahmedabad, 22-23 February 2012

Experimental study of the corrugated waveguide transmission characteristic in 100 GHz to 1 THz frequency range
H. K. B. Pandya, Max Austin and R. F. Ellis

Numerical Activities with DIII-D
N Bisai, R Srinivasan and Asim Chattopadhyay

PATENT APPLIED

A Process for Plasma Oxidation of a Substrate and an Apparatus Therefor
Nirav I. Jamnapara, Suryakant B. Gupta, S. Mukherjee
Indian Patent, Application No.: 3431/MUM/2011

AWARDS and ACHIEVEMENTS

Professor Amita Das has been elected Fellow of Indian Academy of Sciences, Bangalore in the year 2011 under the section "Physics". Her interests include Plasma Physics, Turbulence and Electron Magnetohydrodynamics. She has also been elected a fellow of the Gujarat Science Academy.

Mr. Rajiv Sharma et.al., were awarded "Smt. Shakuntalabai Vyawahare Memorial Best Poster Award" for their contributory paper titled "Experience with Helium Leak and Thermal Shocks test of SST-1 Cryo Components" presented at the International Symposium on Vacuum Science & Technology and its Application for Accelerators (IVS – 2012) held at VECC-SINP Campus, Kolkata, India, 15–17 February 2012 and received cash price of Rs. 5000.00 at the conference.

Ms. Pratibha Gupta won first prize in Hindi Slogan competition on theme "Environment Protection". Prize was awarded at 28th DAE Safety and Occupational Health Professionals Meet organised by Atomic Energy Regulatory Board (AERB) and Indian Rare Earths Limited (IREL) held in Bhubaneswar, Orissa from 24th to 26th Nov 2011.

E 4. INVITED TALK DELIVERED BY IPR STAFF

AMITA DAS

Gave an invited talk on "Collision – less Stopping of Fast Electron Current Pulse in an Inhomogeneous Plasma Medium" at (a) KITP workshop on "The nature of turbulence" in Santa Barbara, (b) the University of California Los Angeles (UCLA) and (c) at the Princeton Plasma Physics Laboratory (PPPL) in Newark during the three months visit to USA (March 15th to June 15th 2011)

Gave an invited talk on "Guiding and Collimation of Electron Current Pulses in a Plasma" at the Plasma Conference – 2011 (Nov 22nd – Nov 25th) and at 1st ASHULA (ASian core program for High energy density Science Using intense LASer photons) workshop (Nov. 25 - 30, 2011), Kanazawa, Japan. Gave an invited talk on "Propagation of Slow Electromagnetic Disturbances in Plasma" at the Indian Academy of Sciences, July (2011).



Gave an invited talk on “Propagation of Slow Electromagnetic Disturbances in Plasma” at the TIFR- HCU meet in Hyderabad, August (2011).

Gave a Colloquium talk on “Propagation of Slow Electromagnetic Disturbances in Plasma” at Physical Research Laboratory, Ahmedabad, August (2011).

Gave an invited talk on “Propagation of Slow Electromagnetic Disturbances in Plasma” at the International Conference on statistical Physics and Non –Linear Dynamics, at the S. N. Bose Centre for Basic sciences, 12- 16th March (2012).

SUDIP SENGUPTA

Gave an invited talk on “Mechanism of Hot Electron Generation in Ultrashort Ultraintense Laser Solidinteraction”, at 1st ASHULA (ASian core program for High energy density Science Using intense LAsER photons) workshop (Nov. 29 - 30, 2011), Kanazawa, Japan.

M. KUNDU

Gave an invited talk on “Laser Plasma Interaction with Extreme Few-Cycle Laser Light”, HCU-TIFR meeting on “Modern optics”, held at Hyderabad Central University, Andhra Pradesh, India, August 1-3, 2011

Gave an invited talk on “Laser-cluster Interaction with Sub-Cycle Pulses: A New Path for Efficient Laser Absorption”, ASHULA-India meeting 2012 (AIM 2012), Mumbai & Aurangabad, India, January 17-20, 2012

R. SRINIVASAN

Gave an invited talk on “India’s Strategy to Fusion Energy” at Magnetic Fusion Energy and Stellarator Roadmapping in the ITER Era workshop, Princeton University, Princeton, USA, Sep 7-10, 2011

S. B. BHATT

Gave an invited talk on “Vacuum system for fusion devices” at International Symposium on Vacuum Science & Technology and its Application for Accelerators (IVS – 2012) held at VECC-SINP Campus, Kolkata, India, 15–17 February 2012

H. K. B. PANDYA, MAX AUSTIN and R. F. ELLIS

Gave an invited talk on “Experimental study of the corrugated waveguide transmission characteristic in 100 GHz to 1 THz frequency range” at 2nd Indo-US Workshop on Magnetic Fusion Research, Institute for Plasma Research, Ahmedabad, 22-23 February 2012

B. SARKAR

Gave an invited talk on “Large Superconducting magnets: Who needs it” at Workshop on Hundred Years of Superconductivity and Birth Centenary Celebration of Prof. A. Bose, Founder President of Indian Cryogenics Council, at VECC, Kolkata, 23 December 2011

V.P. ANITHA

Gave an invited talk on “Interaction of High Power Microwave with Plasma” at University of Wisconsin, on 11th November 2011

PANKAJ KUMAR SRIVASTAVA

Gave an invited talk on “Electron Energy Filter System for LVPD” at Institute of Plasma Physics Chinese Academy of Sciences (ASIPP), Hefei, China, 7th November 2011

ALPHONSA JOSEPH

Gave an invited talk on “Plasma based Coatings for Automobile applications” for a course lecture at Indore, on 4th November 2011.

Gave an invited talk on “Low Pressure Plasma Based Technologies” at National Workshop on Plasma Processing for Thermonuclear Fusion and Industrial Applications, PPT-FIA-2011, KIIT, Bhubaneswar, 10-11 November 2011.

Gave an invited talk on “Surface Modification by Plasma Nitriding Process” at International symposium on Surface Protective coatings and Indo German conference on Surface Engineering SSPC-2011, Bangalore, 7-9 December 2011.

Gave an invited talk on “Low Pressure Plasma Technologies” at Surface Engineering of Metals and Alloys (SEMA 2012), Bengal Engineering Science University (BESU), 1-2 March 2012.

C. BALASUBRAMANIAN

Gave an invited talk on “Plasma processes and Nanomaterials” Guest Lecture delivered at Shah - Schulman Centre for Surface Science and Nanotechnology, Nadiad, 1st April 2011

MUKESH RANJAN

Gave an invited talk on “Growth of metamaterials on pattern substrate”, at ICMAT 2011, Singapore, 26th June – 1st July 2011

Gave an invited talk on “Bi-axial anisotropy in nanoparticles arrays”, at ICANN-2011, IIT Guwahati, 8-10 December 2011.

Gave an invited talk on “Plasmonic coupling in nanoparticles arrays”, at CMMP-2012, S. P. University, 3-5 March 2012.

Gave an invited talk on “Plasmonics for plasmonic solar cell”, at DST workshop on Plasmonics solar cell -2012, Shibpur, Kolkata, 17 March 2012.

Gave an invited talk on “Plasma Surface Engineering Possible Applications in Harnessing Solar Energy”, at CSMCRI, 27 March 2012.

G. RAVI

Gave an invited presentation on “Plasma – A Stealth Tool” at Interactive Meeting on Stealth Technologies, Aeronautical Development Agency, Bangalore, June 2011.

Gave an invited talk on “Thermal Plasma Torch Fundamentals” at National Workshop on Plasma Processing for Thermonuclear Fusion and Industrial Applications (PPTFIA-2011), Bhubneshwar, 10-11 November 2011.

P. M. RAOLE

Gave an invited talk on “Nanoscience and nanotechnology- An Overview” at Workshop on Nanostructured Materials, Properties and future Research Areas in Mechanical Engineering, Charotar University of Science and Technology, Changa, Gujarat, 5th May 2011.

Gave an invited talk on “Nano-materials and Nanostructures in Fusion Research” at Third International Conference on Frontiers in Nanoscience and Technology (Cochin nano-2011), Cochin university of science and technology, Kochi, 14 – 17 August 2011.

Gave an invited talk on “A perspective on requirements and developments of Fusion Reactor Materials” at PPTFIA-2011, Bhubneshwar, 10-11 November 2011.

S. K. NEMA

Gave an invited talk on “Waste Management using Thermal Plasma Technology”, at National Workshop on Plasma Processing for Thermonuclear Fusion and Industrial Application, PPTFIA-2011, KIIT, Bhubaneshwar, 10-11 November 2011.

Gave an invited talk on “Plasma Processing of Polymers at Institute for Plasma Research, India”, at International conference on Plasma Processing of Organic Materials and Polymers (PPOMP 2011), Kottayam, Kerala, 25-27 November 2011.

Gave an invited talk on “Surface Modification of Polymers using Non-Thermal Plasmas – A New Environment Friendly Approach” at International Conference on Advancements in Polymeric Materials (APM-2012), CIPET, Ahmedabad, 10-12 February 2012.

Gave an invited talk on “Plasma Technologies for Clean Energy in Future & Other Applications”, at Pandit Deendayal Petroleum University, Gandhinagar, on Science day 28 February 2012.

Gave an invited talk on “Surface Modification of Polymers using Non-Thermal Plasmas” at National Conference on Advances in Physics (NCAP-2012), Dept. of Physics & Computer Sci., Govt. Nagarjuna P.G. College of Science, Raipur, 15-16 March 2012.

SURYAKANT B. GUPTA

Gave an invited talk on “Aspects of Intense pulsed electric field induced effects for waste water treatment” at School on Pulsed Power Technology [SPPT-2011], Power Beam Society (PSI), VJTI, Mumbai, 23-27 May 2011.

Gave an invited talk on “Applications of non-thermal plasma in biological science” at National Workshop on Plasma Processing for Thermonuclear Fusion & Industrial Applications (PPTFIA-2011), Bhubneshwar, 10-11 November 2011.

Gave an invited talk on “Development of power supplies for plasma based surface engineering & Bioelectrics applications”, at First International Conference on Plasma Processing of Organic Materials and Polymers (PPOMP 2011), Kottayam, Kerala, 25-27 November 2011.

Gave an invited talk on “An introduction to plasma technology” at 2nd International Conference on Current Trends in Technology (NUiCONE-11) held at Nirma University, 8-10 December 2011.

Gave an invited talk on “ISO design overview of SPIX-II system for Spacecraft ESD experiments” at Air force Research laboratory, Albuquerque, NM, USA, 17th February, 2012

Gave an invited talk on “Spacecraft Plasma Interaction eXperiment (SPIX): Current status and future activities” at Jet Propulsion Laboratory, California Institute of Technology, Pasadena, LA, USA, 21st February, 2012

**N. AOMOA**

Gave a talk on “Ozone measurement in an atmospheric pressure DC plasma jet for inactivation study” at Department of Energy Sciences, Tokyo Institute of Technology, Japan, October 2011

M. KAKATI

Gave a talk on “Carbon nanomaterials synthesized with a supersonic plasma assisted technique” at Department of Physics, Pontificia Universidad Catolica de Chile, Santiago, Chile, 19 January 2012

Invited talks given at 26th National Symposium on Plasma Science and Technology (PLASMA–2011) held at Birla Institute of Technology Mesra, Patna, 20–23 December 2011

JOYDEEP GHOSH, D. RAJU, P.K.CHATTOPADHYAY, R.L.TANNA, SANKARJOISA, P.DHYANI, D.SANWAN, S.B.BHATT, C.V.S.RAO, R.JHA, C.N.GUPTA, P.K.ATREY, M.B.CHOWDHURI, Y.C.SAXENA, and ADITYA TEAM gave an Invited talk on “Generation of nonthermal electrons at the Sawtooth crash and their radial transport in ADITYA-tokmak”

U.K.BARUAH and NBI GROUP gave an Invited talk on “Neutral Beam Injection Systems: An Engineering Perspective”

G.RAVI gave an Invited talk on “Studies on Fluctuations and instabilities in a plasma torch”

RAJESH KUMAR, JIGNESH PATEL, ANITA V.P, and ANURAG SHYAM gave an Invited talk on “Viracator based on compact tesla generator for the application in microwave – plasma interaction experiment”

AJAI KUMAR, R.K.SINGH, H.C.JOSHI and V.SIVAKUMARAN gave an Invited talk on “Dynamics of Laser induced plasma in presence of external disturbances: Characterization in context of atomic processes and practical applications”

S. PADASALGI, S. KUMAR, P.VASU gave an Invited talk on “Vibration effects assessment of ITER port plug”

P. BHARATHI gave an Invited talk on “Application of molecular emission spectroscopy in laboratory and fusion edge plasmas”

P.K.ATREY gave an Invited talk on “Microwave interferometer diagnostics in fusion plasma research”

SHANTANU KUMAR KARKARI gave an Invited talk on “Hairpin Resonance Probe for diagnostic of low temperature plasmas”

E 5. TALKS DELIVERED BY DISTINGUISHED VISITORS AT IPR

Dr. Prabhat Munshi, Professor of Mechanical Engineering, Nuclear Engineering and Technology Programme, Indian Institute of Technology, Kanpur, India gave a lecture on “Dilemma of Tomography: Picking the Right Solution from a Set of Correct Solutions”.

Mr. Jayendra N Bandyopadhyay, Centre for Quantum Technologies, National University of Singapore gave a lecture on “Quantum chaotic system as a model of decohering environment”.

Dr. Susanta Das, Manne Siegbahn Laboratory (MSL), Stockholm University, Sweden gave a lecture on “Understanding The Differences Between Electron and Ion Guiding Through Insulating Nanocapillary Foils”.

Dr. Nidhi Shukla, Dept. of Physics, Dr. HS Gour University, (Central), Sagar, M.P.

gave a lecture on “Study of kinetic Alfvén wave in Magnetospheric Plasma”

Dr. Charu Lata Dube, IIT Delhi gave a lecture on “Microwave Processing- A Green Technology for Synthesis of Materials”.

Ms. Swati Baruah, Department of Physics, Tezpur University gave a lecture on “The role of different attractive forces on dust crystal formation”

Mrs. Shikha Rai, Laser Spectroscopy Research Laboratory, Department of Physics, Allahabad University Gave a lecture on “ LIBS study of energetic materials and future plans”

Dr. A.K. Saxena, Director, Defence Materials & Stores Research & Development Establishment (DMSRDE), Kanpur Gave a lecture on “Development of High Heat Flux Material”

Dr. Tulasi Parashar, Sharp Laboratory, Department of Physics & Astronomy, University of Delaware, USA gave a lecture on “On Kinetic Dissipation in Collisionless Turbulent Plasmas”

Dr. Deepak Gupta & Dr. Sangeta Gupta, Tri Alpha Energy (TAE), USA

Gave a lecture on “Long-lived Field-Reversed Configuration Plasma in C-2”

Dr. Naveen C. Pathak, ILIL, Istituto Nazionale di Ottica, Pisa, Italy

Dipartimento di Fisica, E.Fermi University of Pisa, Italy
Gave a lecture on “Laser Plasma Acceleration”.

Dr. Sanjay K. Mishra, Plasma Physics Group, Lucknow University

Gave a lecture on “Our understanding on complex plasma kinetics”

Dr. Viswas Purohit, A.J. Industries, Santa Barbara, CA, USA

Gave a lecture on “ECR plasmas: Diagnostics and Applications”

Dr. Gurusharan Singh Gogna, National Centre for Plasma Science & Technology, Dublin City University, Ireland gave a lecture on “Experimental Study of Hairpin Probe Resonances in Magnetized Plasma”.

Dr. Akhilesh K Arora, Outstanding Scientist and Head, Condensed Matter Physics Division, IGCAR, Kalpakam gave a lecture on “Characterization of nano-structured materials using optical techniques”

Dr. Deepti Kothari, UGC-DAE, CSR, Indore gave a lecture on “Preparation and Characterization of Bismuth Ferrite based multiferroic material”

Prof. S.M. Mahajan, University of Texas, USA gave a lecture “Cosmic Magnetic Fields”

Dr. R. Singh, Science Division, ITER Organization, Cadarache, France gave a lecture on “Theory of Pedestal width and Rapid formation of Pedestal due to Anomalous particle pinch in H-mode discharges - Projections for ITER”

Dr. R. Singh, Science Division, ITER Organization, Cadarache, France gave a lecture on “A Model for Accessing Power to Achieve L-H Transition in Tokamaks and Projections for ITER and SST-1 Tokamaks”

Dr. Anil K. Aria, National Fusion Research Institute, Daejeon, Korea gave a lecture on “Simulation study on Lower Hybrid Current (LHCD) efficiency for KSTAR Tokamak”

Dr. Ratna Kumar Annabattula, Institute for Applied Materials (IAM-WBM), Karlsruhe Institute of Technology, Germany gave a lecture on “A Micromechanical approach to Thermo-mechanics of Pebble Beds”

Dr. Francesco Romanelli, EFDA Leader and JET Leader, Culham Science Center, Abingdon, Oxfordshire gave a lecture on “First results on JET with the ITER-like wall”

Dr. P. Sonato, RFX-mod Team, Padova, Italy gave a lecture on “RFX-mod, device and experiments”

Prof. Mohamed Abdou, Distinguished Professor of Engineering and Applied Science, Founding President, Council of Energy Research and Education Leaders (CEREL), Director, Center for Energy Science and Technology Advanced Research (CESTAR), Director, Fusion Science and Technology Center, University of California, Los Angeles (UCLA), USA gave a lecture on “Fusion Nuclear Science and Technology (FNST) Strategic Issues, challenges, and Facilities on the Pathway to Fusion DEMO”

Mr. Mubarak Mujawar, Dublin City University, Ireland gave a lecture on “Study of Oxygen Negative ions in Anodic Glow region of the Constricted Hollow Anode Plasma Source”

Mr. G. G. Dholakia, Ex Head of Computer Center, Physical Research Laboratory, Navrangpura, Ahmedabad-380009 gave a lecture on “Meeting the challenges in managing IT Services in Scientific Research Organization”

Prof. D.V. Giri, Adjunct Professor in the Dept. of ECE, University of New Mexico, Albuquerque, NM gave a lecture on “High-Power Microwaves (HPM) Sources and Characterization”

E 6. COLLOQUIA PRESENTED AT IPR

Prof. C. S. Unnikrishnan, Gravitation Group, TIFR, Mumbai given a talk on “Gravitational Waves: Physics, Technology and Future Astronomy” (Colloquium # 214)

Dr. S. Balasubramanian, Coordinator, Centre for Computational Material Science, Jawaharlal Nehru Centre for Advanced Scientific Research, Bangalore-560 064, India given a talk on “Modelling Molecular Condensed Matter: Ab initio, Atomistic and Coarse Grained Approaches” (Colloquium # 215)



Prof. Bala Iyer, Raman Research Institute, Bangalore given a talk on “The Search for Gravitational Waves: A century of waiting” (Colloquium # 216)

Mr. B.S.Paradkar, University of California-San Diego,La Jolla, USA given a talk on “Mechanism of Pre-Formed Plasma Electrons Heating in Relativistic Laser-Solid Interactions” (Colloquium # 217)

Mr. Sunil Kumar, CoatingsMantra Science and Technology Consulting Adelaide, Australia given a talk on “Plasma-based Methods for Healthcare and Cleantech Applications” (Colloquium # 218)

Prof. Dilip Angom, Physical Research Laboratory, Ahmedabad given a talk on “Vortex dipoles in Bose-Einstein condensates” (Colloquium #219)

Prof. Chanchal Uberoi, Dept of Mathematics, IISc Bangalore given a talk on “Understanding Space Environment: Using the Guidance Provided by History and the Classical Music of India” (Colloquium #220)

E 7. SCIENTIFIC MEETINGS HOSTED BY IPR

Plasma Physics Teaching at Under Graduate Level A two-day workshop for College Teachers, at IPR, Gandhinagar Organized by IPR, INSA, GCA, IAPT, 29-30 April 2011

An Internal Workshop on “Earthing/Grounding & EMI/EMC” held at IPR on 9-10 February 2012

2nd Indo-US Workshop on Magnetic Fusion Research, Institute for Plasma Research, Ahmedabad, 22-23 February 2012

A scientific meeting was held with Prof. D.V. Giri, Adjunct Professor in the Dept. of ECE, University of New Mexico, Albuquerque, NM, and Microwave Plasma Division group members, and experts of IPR including Prof. Kaw, during the period, 27-30 March, 2012

--!!!--

Audited Statements of Accounts
as on 31st March 2012
INSTITUTE FOR PLASMA
RESEARCH

Registration No.GUJ/88/GANDHINAGAR



T. N. Shah & Co.
CHARTERED ACCOUNTANTS

CAN. B. SHAH, B. Com., F.C.A.
CAT. N. SHAH, B. Com., F.C.A., DISA

PHONE : +91 079 23222152
Fax : +91 079 23241432
Firm Reg. No. 109802W
C. & A. G. Reg. No. WR/0534
Email : tnshahincometax@gmail.com

AUDITOR'S REPORT

We have audited the attached Balance Sheet of INSTITUTE FOR PLASAMA RESEARCH, GANDHINAGAR, as at 31st March, 2012, Income & Expenditure Account and also the Receipts and Payments Account for the year ended on that date annexed thereto. These Financial Statements are the responsibility of the Institute's management. Our responsibility is to express an opinion on these financial statements based on our audit.

We conducted our audit in accordance with auditing standards generally accepted in India. Those standards require that we plan and perform the audit to obtain reasonable assurance about whether the financial statements are free from material misstatements. An audit includes examining, on test basis, evidence supporting the amounts and disclosures in the financial statements. An audit also includes assessing the accounting principles used and significant estimates made by management, as well as evaluating the overall financial statement presentation. We believe that our audit provides a reasonable basis for our opinion.

- (i) We have obtained all the information and explanations, which to the best of our knowledge and belief were necessary for the purpose of our audit.
- (ii) In our opinion, proper books of account as required by law have been kept by the Institute so far as appears from our examination of those books.
- (iii) In our opinion and to the best of our information and according to the explanations given to us, the said accounts read together with the notes give a true and fair view:
 - (a) in the case of the Balance Sheet, of the state of affairs of the Institute as at 31st March, 2012;
 - (b) in the case of the Income & Expenditure Account, of the excess of Income over Expenditure for the year ended on that date;
 - (c) in the case of the Receipts and Payments Account, of the receipts and payments for the year ended on that date.

Place: Gandhinagar
Dated: 31/07/2012



For T.N.Shah & Co.,
Chartered Accountants
Firm Registration No.109802W

(Tushar N. Shah)
Partner
Membership No.042748

Office : 503, "ABHISHEK", Opp. Hotel Fortune in Haveli, Sector-11, Gandhinagar-382011.

INSTITUTE FOR PLASMA RESEARCH
BHAT, GANDHINAGAR – 382 428
 (Sponsored by Dept. of Atomic Energy, Govt. of India, Mumbai)
 Registration No. GUJ/88/GANDHINAGAR

BALANCE SHEET AS AT 31ST MARCH, 2012

<u>CORPUS/CAPITAL FUND AND LIABILITIES</u>	SCH.	2011-12	2010-11
CORPUS/CAPITAL FUND	1	2,87,74,13,669.00	2,52,44,67,125.00
RESERVES AND SURPLUS	2	5,57,70,07,745.00	3,79,94,10,473.00
EARMARKED/ENDOWMENT FUNDS	3	18,97,28,062.00	15,32,84,372.00
CURRENT LIABILITIES AND PROVISIONS	4	64,49,84,446.00	53,93,03,120.00
TOTAL		9,28,91,33,922.00	7,01,64,65,090.00
<hr/>			
<u>ASSETS</u>			
FIXED ASSETS	5	3,25,04,17,113.00	2,83,33,22,720.00
CURRENT ASSETS, LOANS, ADVANCES ETC.	6	6,03,87,16,809.00	4,18,31,42,370.00
TOTAL		9,28,91,33,922.00	7,01,64,65,090.00
SIGNIFICANT ACCOUNTING POLICIES	13		
CONTINGENT LIABILITIES AND NOTES ON ACCOUNTS	14		

As per our report of even date attached.

For T.N.Shah & Co.,
Chartered Accountants

-Sd-
(Prof. P.K. Kaw)
Director

-Sd-
(Prof.R.Jha)
Dean

-Sd-
(H.K.Sharma)
Accounts Officer-I

-Sd-
(Tushar N. Shah)
Partner
Membership No. 042748

Place : Gandhinagar
Dated :31/07/2012

INSTITUTE FOR PLASMA RESEARCH
BHAT, GANDHINAGAR – 382 428
(Sponsored by Dept. of Atomic Energy, Govt. of India, Mumbai)
Registration No. GUJ/88/GANDHINAGAR

INCOME AND EXPENDITURE ACCOUNT FOR THE PERIOD ENDED
ON 31ST MARCH, 2012

<u>A. INCOME</u>	SCH	2011-12	2010-11
Grants- Department of Atomic Energy, Govt. of India	7	4,51,64,00,000.00	3,82,63,00,000.00
Interest Earned	8	19,96,21,999.00	7,84,11,547.00
Other Income	9	14,24,696.00	44,43,274.00
Surplus on Sale of Assets		60,388.00	-
TOTAL (A)		4,71,75,07,083.00	3,90,91,54,821.00
<u>B. EXPENDITURE</u>			
Establishment Expenses	10	53,14,25,032.00	51,97,78,648.00
Other Administrative Expenses	11	55,18,55,841.00	46,83,60,454.00
National Fusion Programme (Human Resource Development Expenses)		4,55,06,020.00	4,42,71,271.00
Cash Contribution to ITER IO		1,24,95,29,636.00	1,09,56,90,363.00
Depreciation	12	20,81,46,320.00	18,24,79,507.00
Less : Transfer from Corpus/Capital Fund		<u>(20,81,46,320.00)</u>	<u>(18,24,79,507.00)</u>
		-	-
Loss on Disposal of Capital Assets/Write off		5,05,624.00	3,16,253.00
TOTAL (B)		2,37,88,22,153.00	2,12,84,16,989.00
Balance being excess of Income over Expenditure		2,33,86,84,930.00	1,78,07,37,832.00
Transfer to Corpus Fund for addition to Movable & Immovable Properties		56,18,55,276.00	40,38,90,607.00
Transfer From Corpus Fund for w/off to Movable/Immovable Properties		(7,62,412.00)	(5,61,253.00)
Transfer to/from unspent Grant A/c		1,77,75,92,066.00	1,37,74,08,478.00
SIGNIFICANT ACCOUNTING POLICIES	13		
CONTINGENT LIABILITIES AND NOTES ON ACCOUNTS	14		

As per our report of even date attached.

For T.N.Shah & Co.,
Chartered Accountants

-Sd-
(Prof. P.K. Kaw)
Director

-Sd-
(Prof.R.J ha)
Dean

-Sd-
(H.K.Sharma)
Accounts Officer-I

-Sd-
(Tushar N. Shah)
Partner
Membership No. 042748

Place : Gandhinagar
Dated :31/07/2012

INSTITUTE FOR PLASMA RESEARCH
BHAT, GANDHINAGAR – 382 428
(Sponsored by Dept. of Atomic Energy, Govt. of India, Mumbai)
Registration No. GUJ/88/GANDHINAGAR

RECEIPTS	2011-12	2010-11	PAYMENTS	2011-12	2010-11
I. Opening Balances			I. Expenses		
a) Cash in hand	1,14,497.00	1,54,439.00	a) Establishment Expenses	42,44,22,959.00	37,03,32,079.00
b) Bank Balances			b) Administrative Expenses	55,55,13,547.00	46,35,36,564.00
i) In Current accounts	10,36,67,520.00	11,93,93,499.00	c) National Fusion Programme (Human Resource Development Expenses)	4,55,06,020.00	4,42,71,271.00
ii) In deposit accounts	2,62,09,03,879.00	1,44,86,14,764.00	d) Cash Contribution to ITER-IO	1,24,95,29,636.00	1,09,56,90,363.00
iii) Savings accounts	3,53,35,952.00	3,39,27,475.00			
II. Grant Received			II. Exp. on Fixed Assets, Cap. WIP & Others		
a) From Govt. of India- DAE	4,51,64,00,000.00	3,82,63,00,000.00	a) Purchase of Fixed Assets & other exp.	35,16,24,048.00	25,88,62,130.00
b) From Assam Govt for CPP	-	-	b) Expenditure on Capital WIP	27,77,30,140.00	8,40,51,262.00
III. Interest Received			III. Refund of Surplus money/Loans		
a) On Bank Deposits	18,91,66,125.00	6,55,60,689.00	a) Deposits with Government Auth. & Suppliers/Security Deposits	-	33,46,122.00
b) Loans, Advances etc.	12,71,141.00	21,95,434.00	b) Payments against Earmarked Funds	12,07,61,452.00	7,79,79,905.00
IV. Other Income			IV. Other Payments (Specify)		
Royalty & Transfer Fee Income	3,72,461.00	2,87,742.00	a) Advances to Contractors & Suppliers (Including Adv. for Capital Works)	59,36,96,964.00	47,58,25,083.00
V. Any Other receipts			b) Stock (Change in closing Bal.)	(4,08,308.00)	4,77,819.00
Amount received for Earmarked/ Endowment Funds	15,61,49,886.00	11,64,99,205.00	c) Payment of LT Advances to Empl.	21,55,681.00	49,17,519.00
Security Deposits	68,03,138.00	36,18,347.00	e) Others	1,63,76,491.00	8,33,49,592.00
Others	46,354.00	9,58,63,126.00	V. Closing Balances		
Receipt of LT Advances to Empl.	37,71,082.00	58,46,304.00	a) Cash in hand	1,54,625.00	1,14,497.00
Sale of Capital Assets	2,88,600.00	2,45,000.00	b) Bank Balances		
Am't recd against non receipt of Books /journals	22,175.00	-	i) In Current accounts	7,01,86,055.00	10,36,67,520.00
			ii) In deposit accounts	3,86,08,54,442.00	2,62,09,03,879.00
			iii) Savings accounts	6,72,61,293.00	3,53,35,951.00
			TOTAL	7,63,53,65,045.00	5,72,26,61,556.00
			TOTAL	7,63,53,65,045.00	5,72,26,61,556.00

As per our report of even date attached.

For T.N.Shah & Co.

Chartered Accountants

-Sd-

(Tushar.N.Shah)

Partner

Membership No. 042748

-Sd-

(H.K.Sharma)

Accounts Officer-I

-Sd-

(Prof.R.Jha)

Dean

-Sd-

(Prof.P.K.Kaw)

Director

Place : Gandhinagar
Dated :31/07/2012

**INSTITUTE FOR PLASMA RESEARCH
BHAT, GANDHINAGAR – 382 428**

(Sponsored by Dept. of Atomic Energy, Govt. of India, Mumbai)
Registration No. GUJ/88/GANDHINAGAR

SCHEDULES FORMING PART OF BALANCE SHEET AS AT 31ST MARCH, 2012		2011-12	2010-11
PARTICULARS			
SCHEDULE 1 - CORPUS CAPITAL FUND :-			
Balance as at the beginning of the year		2,52,44,67,125.00	2,30,36,17,278.00
Balance of ITER-India due to merger	-		-
Balance of CPP-IPR due to merger	-		-
Add: Transfer from Unspent Grant & Addition during the year	-		-
Less: Amount trfd to Unspent Grant	-		-
Add: Contribution towards Corpus/Capital Fund	56,18,55,276.00		40,38,90,607.00
(Deduct) : Depreciation charged on Capital Assets for FY 2011-12	20,81,46,320.00		18,24,79,507.00
transferred to Income & Expenditure A/c			
Addition/Deduction during the year	(7,62,412.00)		(5,61,253.00)
(transfer to/from I & E Account)			
BALANCE AS AT 31ST MARCH, 2012		2,87,74,13,669.00	2,52,44,67,125.00

SCHEDULE 2 - RESERVE AND SURPLUS :-

1. Unspent Grant :			
As per last Account	3,79,94,15,679.00		2,42,43,82,393.00
a) Balance of ITER-India due to merger	-		-
b) Balance of CPP-IPR due to merger	-		-
Add: Transfer from Corpus Fund	-		-
Less: Amount trfd to Corpus Fund	-		-
Less: Amount trfd to Earmarked Fund	-		(9,67,192.00)
Addition/Deduction during the year	1,77,75,92,066.00		(14,08,000.00)
(transfer to/from I & E A/c)			
Addition/Deduction during the year	5,57,70,07,745.00		3,79,94,15,679.00
c) ITER-India Project	-		-
d) CPP-IPR	-		(5,206.00)
BALANCE AS AT 31ST MARCH, 2012		5,57,70,07,745.00	3,79,94,10,473.00

INSTITUTE FOR PLASMA RESEARCH
BHAT, GANDHINAGAR – 382 428
(Sponsored by Dept. of Atomic Energy, Govt. of India, Mumbai)
Registration No. GUJ/88/GANDHINAGAR

SCHEDULES FORMING PART OF BALANCE SHEET AS AT 31ST MARCH, 2012

<u>SCHEDULE 3 – EARMARKED/ ENDOWMENT FUNDS :</u>	a) Opening Balance of the fund	b) Additions to the Funds	TOTAL (a+b)	c) Utilisation/ Expenditure towards objectives of funds	NET BALANCE AS AT 31ST MARCH, 2012 (a+b-c)	NET BALANCE AS AT 31ST MARCH, 2011
<u>FUND-WISE BREAK UP</u>						
A <u>IPR PROJECT</u>						
1 F.C.L.P.T. - Metal Treat	(6,84,916.00)	-	(6,84,916.00)	-	(6,84,916.00)	(6,84,916.00)
2 F.C.L.P.T. - NIPC	2,52,817.00	-	2,52,817.00	2,52,817.00	-	2,52,817.00
3 F.C.L.P.T. - SAMTEL	52,173.00	-	52,173.00	52,173.00	-	52,173.00
4 F.C.L.P.T. - SPIX	35,64,106.00	-	35,64,106.00	5,71,886.00	29,92,220.00	35,64,106.00
5 F.C.L.P.T. - TIF-SK	(9,90,605.00)	9,90,605.00	-	-	-	(9,90,605.00)
6 F.C.L.P.T. - TIF-HP	14,534.00	-	14,534.00	14,534.00	-	14,534.00
7 F.C.L.P.T. - TIF-GOA	(55,933.00)	55,933.00	-	-	-	(55,933.00)
8 F.C.L.P.T. - TRITON	1,75,297.00	-	1,75,297.00	1,75,297.00	-	1,75,297.00
9 F.C.L.P.T. - UVSYSTEME	8,00,905.00	-	8,00,905.00	-	8,00,905.00	8,00,905.00
10 F.C.L.P.T. - IGCAR - TEFLON	1,19,168.00	-	1,19,168.00	1,19,168.00	-	1,19,168.00
11 F.C.L.P.T. - DRDL-SJ	65,705.00	-	65,705.00	65,705.00	-	65,705.00
12 F.C.L.P.T. - PECVD	(27,79,678.00)	27,79,678.00	-	-	-	(27,79,678.00)
13 F.C.L.P.T. - ISAC	15,46,617.00	-	15,46,617.00	15,46,617.00	-	15,46,617.00
14 Plasma Nitriding Jobshop	-	-	-	-	-	-
15 F.C.L.P.T. - Surface Lab	-	-	-	-	-	-
16 F.C.L.P.T. - CAE	83,090.00	-	83,090.00	83,090.00	-	83,090.00
17 F.C.L.P.T. - SPT	2,11,584.00	-	2,11,584.00	2,11,584.00	-	2,11,584.00
18 F.C.L.P.T. - GERES	8,18,000.00	-	8,18,000.00	8,18,000.00	-	8,18,000.00
19 F.C.L.P.T. - LPSC-LP	(5,27,716.00)	5,27,716.00	-	-	-	(5,27,716.00)
20 F.C.L.P.T. - IGCAR - PECVD	(7,63,498.00)	-	(7,63,498.00)	-	(7,63,498.00)	(7,63,498.00)
21 F.C.L.P.T. - IGCAR - EPA	(21,73,590.00)	-	(21,73,590.00)	-	(21,73,590.00)	(21,73,590.00)
22 F.C.L.P.T. - DST - UP	16,51,418.00	-	16,51,418.00	-	16,51,418.00	16,51,418.00
23 F.C.L.P.T. - DST - HR	(7,60,316.00)	7,60,316.00	-	-	-	(7,60,316.00)
24 F.C.L.P.T. - DST - AP	(10,46,921.00)	10,64,101.00	17,180.00	17,180.00	-	(10,46,921.00)
25 F.C.L.P.T. - ANGORA	(6,97,198.00)	6,97,198.00	-	-	-	(6,97,198.00)
26 F.C.L.P.T. - MHSC	(9,44,115.00)	9,44,115.00	-	-	-	(9,44,115.00)
27 F.C.L.P.T. - RHVPS	2,28,54,453.00	1,81,08,000.00	4,09,62,453.00	50,48,006.00	3,59,14,447.00	2,28,54,453.00
28 F.C.L.P.T. - PAID	3,81,202.00	-	3,81,202.00	3,81,202.00	-	3,81,202.00
29 F.C.L.P.T. - TBRL - II	3,48,688.00	-	3,48,688.00	3,48,688.00	-	3,48,688.00
30 F.C.L.P.T. - RCTL - II	4,74,393.00	-	4,74,393.00	4,74,393.00	-	4,74,393.00
31 F.C.L.P.T. - MNIT	(63,591.00)	-	(63,591.00)	-	(63,591.00)	(63,591.00)
32 F.C.L.P.T. - DST - 50	(15,10,831.00)	15,10,831.00	-	-	-	(15,10,831.00)
33 F.C.L.P.T. - PDS	71,731.00	-	71,731.00	-	71,731.00	71,731.00
34 F.C.L.P.T. - CFES - 1	(1,47,387.00)	-	(1,47,387.00)	(1,47,387.00)	-	(1,47,387.00)
35 F.C.L.P.T. - TBRL - 3	2,58,643.00	-	2,58,643.00	2,58,643.00	-	2,58,643.00
36 F.C.L.P.T. - RKT	(4,18,065.00)	5,82,000.00	1,63,935.00	1,63,935.00	-	(4,18,065.00)
37 F.C.L.P.T. - CPCB1	(55,554.00)	-	(55,554.00)	(55,554.00)	-	(55,554.00)
38 F.C.L.P.T. - RCTL3	34,082.00	2,89,184.00	3,23,266.00	863.00	3,22,403.00	34,082.00
39 F.C.L.P.T. - DU	(38,86,715.00)	38,86,715.00	-	-	-	(38,86,715.00)
40 F.C.L.P.T. - DST2	63,47,657.00	-	63,47,657.00	37,58,828.00	25,88,829.00	63,47,657.00
41 F.C.L.P.T. - PROCTOR & GAMBLE	98,20,237.00	64,29,769.00	1,62,50,006.00	38,21,215.00	1,24,28,791.00	98,20,237.00
42 F.C.L.P.T. - CPP	95,836.00	-	95,836.00	95,836.00	-	95,836.00
43 F.C.L.P.T. - FILITREX	4,84,955.00	-	4,84,955.00	-	4,84,955.00	4,84,955.00
44 F.C.L.P.T. - LP-RU	2,43,979.00	2,10,000.00	4,53,979.00	69,374.00	3,84,605.00	2,43,979.00
45 BRNS - EPIA - AD	42,55,540.00	-	42,55,540.00	13,43,750.00	29,11,790.00	42,55,540.00
46 TIFAC - IMF	3,20,782.00	-	3,20,782.00	-	3,20,782.00	3,20,782.00
47 RRF -TKB	(7,469.00)	5,55,541.00	5,48,072.00	10,25,748.00	(4,77,676.00)	(7,469.00)
48 PEF - 1	(52,53,007.00)	52,53,007.00	-	3,68,426.00	(3,68,426.00)	(52,53,007.00)
49 BARC - PPG - S & M	(21,01,506.00)	21,33,386.00	31,880.00	31,880.00	-	(21,01,506.00)
50 BARC - CAD - Project	(22,17,628.00)	22,17,628.00	-	-	-	(22,17,628.00)

Audited Statements of Accounts
as on 31st March 2012
INSTITUTE FOR PLASMA
RESEARCH

Registration No.GUJ/88/GANDHINAGAR



T. N. Shah & Co.
CHARTERED ACCOUNTANTS

CAN. B. SHAH, B. Com., F.C.A.
CAT. N. SHAH, B. Com., F.C.A., DISA

PHONE : +91 079 23222152
Fax : +91 079 23241432
Firm Reg. No. 109802W
C. & A. G. Reg. No. WR/0534
Email : tnshahincometax@gmail.com

AUDITOR'S REPORT

We have audited the attached Balance Sheet of INSTITUTE FOR PLASAMA RESEARCH, GANDHINAGAR, as at 31st March, 2012, Income & Expenditure Account and also the Receipts and Payments Account for the year ended on that date annexed thereto. These Financial Statements are the responsibility of the Institute's management. Our responsibility is to express an opinion on these financial statements based on our audit.

We conducted our audit in accordance with auditing standards generally accepted in India. Those standards require that we plan and perform the audit to obtain reasonable assurance about whether the financial statements are free from material misstatements. An audit includes examining, on test basis, evidence supporting the amounts and disclosures in the financial statements. An audit also includes assessing the accounting principles used and significant estimates made by management, as well as evaluating the overall financial statement presentation. We believe that our audit provides a reasonable basis for our opinion.

- (i) We have obtained all the information and explanations, which to the best of our knowledge and belief were necessary for the purpose of our audit.
- (ii) In our opinion, proper books of account as required by law have been kept by the Institute so far as appears from our examination of those books.
- (iii) In our opinion and to the best of our information and according to the explanations given to us, the said accounts read together with the notes give a true and fair view:
 - (a) in the case of the Balance Sheet, of the state of affairs of the Institute as at 31st March, 2012;
 - (b) in the case of the Income & Expenditure Account, of the excess of Income over Expenditure for the year ended on that date;
 - (c) in the case of the Receipts and Payments Account, of the receipts and payments for the year ended on that date.

Place: Gandhinagar
Dated: 31/07/2012

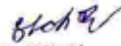

For T.N.Shah & Co.,
Chartered Accountants
Firm Registration No.109802W

(Tushar N. Shah)
Partner
Membership No.042748

Office : 503, "ABHISHEK", Opp. Hotel Fortune in Haveli, Sector-11, Gandhinagar-382011.

INSTITUTE FOR PLASMA RESEARCH
BHAT, GANDHINAGAR – 382 428
 (Sponsored by Dept. of Atomic Energy, Govt. of India, Mumbai)
 Registration No. GUJ/88/GANDHINAGAR

BALANCE SHEET AS AT 31ST MARCH, 2012

<u>CORPUS/CAPITAL FUND AND LIABILITIES</u>	SCH.	2011-12	2010-11
CORPUS/CAPITAL FUND	1	2,87,74,13,669.00	2,52,44,67,125.00
RESERVES AND SURPLUS	2	5,57,70,07,745.00	3,79,94,10,473.00
EARMARKED/ENDOWMENT FUNDS	3	18,97,28,062.00	15,32,84,372.00
CURRENT LIABILITIES AND PROVISIONS	4	64,49,84,446.00	53,93,03,120.00
TOTAL		9,28,91,33,922.00	7,01,64,65,090.00
<hr/>			
<u>ASSETS</u>			
FIXED ASSETS	5	3,25,04,17,113.00	2,83,33,22,720.00
CURRENT ASSETS, LOANS, ADVANCES ETC.	6	6,03,87,16,809.00	4,18,31,42,370.00
TOTAL		9,28,91,33,922.00	7,01,64,65,090.00
SIGNIFICANT ACCOUNTING POLICIES	13		
CONTINGENT LIABILITIES AND NOTES ON ACCOUNTS	14		

As per our report of even date attached.

For T.N.Shah & Co.,
Chartered Accountants

-Sd-
(Prof. P.K. Kaw)
Director

-Sd-
(Prof.R.Jha)
Dean

-Sd-
(H.K.Sharma)
Accounts Officer-I

-Sd-
(Tushar N. Shah)
Partner
Membership No. 042748

Place : Gandhinagar
Dated :31/07/2012

INSTITUTE FOR PLASMA RESEARCH
BHAT, GANDHINAGAR – 382 428
(Sponsored by Dept. of Atomic Energy, Govt. of India, Mumbai)
Registration No. GUJ/88/GANDHINAGAR

INCOME AND EXPENDITURE ACCOUNT FOR THE PERIOD ENDED
ON 31ST MARCH, 2012

<u>A. INCOME</u>	SCH	2011-12	2010-11
Grants- Department of Atomic Energy, Govt. of India	7	4,51,64,00,000.00	3,82,63,00,000.00
Interest Earned	8	19,96,21,999.00	7,84,11,547.00
Other Income	9	14,24,696.00	44,43,274.00
Surplus on Sale of Assets		60,388.00	-
TOTAL (A)		4,71,75,07,083.00	3,90,91,54,821.00
<hr/>			
<u>B. EXPENDITURE</u>			
Establishment Expenses	10	53,14,25,032.00	51,97,78,648.00
Other Administrative Expenses	11	55,18,55,841.00	46,83,60,454.00
National Fusion Programme (Human Resource Development Expenses)		4,55,06,020.00	4,42,71,271.00
Cash Contribution to ITER IO		1,24,95,29,636.00	1,09,56,90,363.00
Depreciation	12	20,81,46,320.00	18,24,79,507.00
Less : Transfer from Corpus/Capital Fund		<u>(20,81,46,320.00)</u>	<u>(18,24,79,507.00)</u>
		-	-
Loss on Disposal of Capital Assets/Write off		5,05,624.00	3,16,253.00
TOTAL (B)		2,37,88,22,153.00	2,12,84,16,989.00
Balance being excess of Income over Expenditure		2,33,86,84,930.00	1,78,07,37,832.00
Transfer to Corpus Fund for addition to Movable & Immovable Properties		56,18,55,276.00	40,38,90,607.00
Transfer From Corpus Fund for w/off to Movable/Immovable Properties		(7,62,412.00)	(5,61,253.00)
Transfer to/from unspent Grant A/c		1,77,75,92,066.00	1,37,74,08,478.00
SIGNIFICANT ACCOUNTING POLICIES	13		
CONTINGENT LIABILITIES AND NOTES ON ACCOUNTS	14		

As per our report of even date attached.

For T.N.Shah & Co.,
Chartered Accountants

-Sd-
(Prof. P.K. Kaw)
Director

-Sd-
(Prof.R.J ha)
Dean

-Sd-
(H.K.Sharma)
Accounts Officer-I

-Sd-
(Tushar N. Shah)
Partner
Membership No. 042748

Place : Gandhinagar
Dated :31/07/2012

**INSTITUTE FOR PLASMA RESEARCH
BHAT, GANDHINAGAR – 382 428**

(Sponsored by Dept. of Atomic Energy, Govt. of India, Mumbai)
Registration No. GUJ/88/GANDHINAGAR

SCHEDULES FORMING PART OF BALANCE SHEET AS AT 31ST MARCH, 2012	
PARTICULARS	2011-12
SCHEDULE 1 - CORPUS CAPITAL FUND :-	
Balance as at the beginning of the year	2,30,36,17,278.00
Balance of ITER-India due to merger	-
Balance of CPP-IPR due to merger	-
Add: Transfer from Unspent Grant & Addition during the year	-
Less: Amount trfd to Unspent Grant	-
Add: Contribution towards Corpus/Capital Fund	40,38,90,607.00
(Deduct) : Depreciation charged on Capital Assets for FY 2011-12	18,24,79,507.00
transferred to Income & Expenditure A/c	
Addition/Deduction during the year	(5,61,253.00)
(transfer to/from I & E Account)	
BALANCE AS AT 31ST MARCH, 2012	2,52,44,67,125.00
BALANCE AS AT 31ST MARCH, 2012	2,52,44,67,125.00

SCHEDULES FORMING PART OF BALANCE SHEET AS AT 31ST MARCH, 2012	
PARTICULARS	2011-12
SCHEDULE 2 - RESERVE AND SURPLUS :-	
1. Unspent Grant :	
As per last Account	3,79,94,15,679.00
a) Balance of ITER-India due to merger	2,42,43,82,393.00
b) Balance of CPP-IPR due to merger	-
Add: Transfer from Corpus Fund	-
Less: Amount trfd to Corpus Fund	-
Less: Amount trfd to Earmarked Fund	(9,67,192.00)
Addition/Deduction during the year	(14,08,000.00)
(transfer to/from I & E A/c)	
Addition/Deduction during the year	1,37,74,08,478.00
c) ITER-India Project	
d) CPP-IPR	-
	5,57,70,07,745.00
	-
	(5,206.00)
BALANCE AS AT 31ST MARCH, 2012	3,79,94,15,679.00
BALANCE AS AT 31ST MARCH, 2012	3,79,94,15,679.00

INSTITUTE FOR PLASMA RESEARCH
BHAT, GANDHINAGAR – 382 428
(Sponsored by Dept. of Atomic Energy, Govt. of India, Mumbai)
Registration No. GUJ/88/GANDHINAGAR

SCHEDULES FORMING PART OF BALANCE SHEET AS AT 31ST MARCH, 2012

<u>SCHEDULE 3 – EARMARKED/ ENDOWMENT FUNDS :</u>	a) Opening Balance of the fund	b) Additions to the Funds	TOTAL (a+b)	c) Utilisation/ Expenditure towards objectives of funds	NET BALANCE AS AT 31ST MARCH, 2012 (a+b-c)	NET BALANCE AS AT 31ST MARCH, 2011
<u>FUND-WISE BREAK UP</u>						
A <u>IPR PROJECT</u>						
1	F.C.L.P.T. - Metal Treat	(6,84,916.00)	-	(6,84,916.00)	-	(6,84,916.00)
2	F.C.L.P.T. - NIPC	2,52,817.00	-	2,52,817.00	2,52,817.00	-
3	F.C.L.P.T. - SAMTEL	52,173.00	-	52,173.00	52,173.00	-
4	F.C.L.P.T. - SPIX	35,64,106.00	-	35,64,106.00	5,71,886.00	29,92,220.00
5	F.C.L.P.T. - TIF-SK	(9,90,605.00)	9,90,605.00	-	-	(9,90,605.00)
6	F.C.L.P.T. - TIF-HP	14,534.00	-	14,534.00	14,534.00	-
7	F.C.L.P.T. - TIF-GOA	(55,933.00)	55,933.00	-	-	(55,933.00)
8	F.C.L.P.T. - TRITON	1,75,297.00	-	1,75,297.00	1,75,297.00	-
9	F.C.L.P.T. - UVSYSTEM	8,00,905.00	-	8,00,905.00	-	8,00,905.00
10	F.C.L.P.T. - IGCAR - TEFLON	1,19,168.00	-	1,19,168.00	1,19,168.00	-
11	F.C.L.P.T. - DRDL-SJ	65,705.00	-	65,705.00	65,705.00	-
12	F.C.L.P.T. - PECVD	(27,79,678.00)	27,79,678.00	-	-	(27,79,678.00)
13	F.C.L.P.T. - ISAC	15,46,617.00	-	15,46,617.00	15,46,617.00	-
14	Plasma Nitriding Jobshop	-	-	-	-	-
15	F.C.L.P.T. - Surface Lab	-	-	-	-	-
16	F.C.L.P.T. - CAE	83,090.00	-	83,090.00	83,090.00	-
17	F.C.L.P.T. - SPT	2,11,584.00	-	2,11,584.00	2,11,584.00	-
18	F.C.L.P.T. - GERES	8,18,000.00	-	8,18,000.00	8,18,000.00	-
19	F.C.L.P.T. - LPSC-LP	(5,27,716.00)	5,27,716.00	-	-	(5,27,716.00)
20	F.C.L.P.T. - IGCAR - PECVD	(7,63,498.00)	-	(7,63,498.00)	-	(7,63,498.00)
21	F.C.L.P.T. - IGCAR - EPA	(21,73,590.00)	-	(21,73,590.00)	-	(21,73,590.00)
22	F.C.L.P.T. - DST - UP	16,51,418.00	-	16,51,418.00	-	16,51,418.00
23	F.C.L.P.T. - DST - HR	(7,60,316.00)	7,60,316.00	-	-	(7,60,316.00)
24	F.C.L.P.T. - DST - AP	(10,46,921.00)	10,64,101.00	17,180.00	17,180.00	(10,46,921.00)
25	F.C.L.P.T. - ANGORA	(6,97,198.00)	6,97,198.00	-	-	(6,97,198.00)
26	F.C.L.P.T. - MHSC	(9,44,115.00)	9,44,115.00	-	-	(9,44,115.00)
27	F.C.L.P.T. - RHVPS	2,28,54,453.00	1,81,08,000.00	4,09,62,453.00	50,48,006.00	3,59,14,447.00
28	F.C.L.P.T. - PAID	3,81,202.00	-	3,81,202.00	3,81,202.00	-
29	F.C.L.P.T. - TBRL - II	3,48,688.00	-	3,48,688.00	3,48,688.00	-
30	F.C.L.P.T. - RCTL - II	4,74,393.00	-	4,74,393.00	4,74,393.00	-
31	F.C.L.P.T. - MNIT	(63,591.00)	-	(63,591.00)	-	(63,591.00)
32	F.C.L.P.T. - DST - 50	(15,10,831.00)	15,10,831.00	-	-	(15,10,831.00)
33	F.C.L.P.T. - PDS	71,731.00	-	71,731.00	-	71,731.00
34	F.C.L.P.T. - CFES - 1	(1,47,387.00)	-	(1,47,387.00)	(1,47,387.00)	-
35	F.C.L.P.T. - TBRL - 3	2,58,643.00	-	2,58,643.00	2,58,643.00	-
36	F.C.L.P.T. - RKT	(4,18,065.00)	5,82,000.00	1,63,935.00	1,63,935.00	(4,18,065.00)
37	F.C.L.P.T. - CPCB1	(55,554.00)	-	(55,554.00)	(55,554.00)	-
38	F.C.L.P.T. - RCTL3	34,082.00	2,89,184.00	3,23,266.00	863.00	3,22,403.00
39	F.C.L.P.T. - DU	(38,86,715.00)	38,86,715.00	-	-	(38,86,715.00)
40	F.C.L.P.T. - DST2	63,47,657.00	-	63,47,657.00	37,58,828.00	25,88,829.00
41	F.C.L.P.T. - PROCTOR & GAMBLE	98,20,237.00	64,29,769.00	1,62,50,006.00	38,21,215.00	1,24,28,791.00
42	F.C.L.P.T. - CPP	95,836.00	-	95,836.00	95,836.00	-
43	F.C.L.P.T. - FILITREX	4,84,955.00	-	4,84,955.00	-	4,84,955.00
44	F.C.L.P.T. - LP-RU	2,43,979.00	2,10,000.00	4,53,979.00	69,374.00	3,84,605.00
45	BRNS - EPIA - AD	42,55,540.00	-	42,55,540.00	13,43,750.00	29,11,790.00
46	TIFAC - IMF	3,20,782.00	-	3,20,782.00	-	3,20,782.00
47	RRF -TKB	(7,469.00)	5,55,541.00	5,48,072.00	10,25,748.00	(4,77,676.00)
48	PEF - 1	(52,53,007.00)	52,53,007.00	-	3,68,426.00	(52,53,007.00)
49	BARC - PPG - S & M	(21,01,506.00)	21,33,386.00	31,880.00	31,880.00	(21,01,506.00)
50	BARC - CAD - Project	(22,17,628.00)	22,17,628.00	-	-	(22,17,628.00)

INSTITUTE FOR PLASMA RESEARCH
BHAT, GANDHINAGAR – 382 428
(Sponsored by Dept. of Atomic Energy, Govt. of India, Mumbai)
Registration No. GUJ/88/GANDHINAGAR

51	BARC - EED- Project	(76,28,742.00)	22,703.00	(76,06,039.00)	4,10,30,852.00	(4,86,36,891.00)	-76,28,742.00
52	IUAC - RF	1,93,684.00	-	1,93,684.00	1,93,684.00	-	1,93,684.00
53	DST - TSG-GYRO- RF	7,42,84,106.00	61,94,000.00	8,04,78,106.00	91,07,418.00	7,13,70,688.00	7,42,84,106.00
54	DST - DADD	96,097.00	-	96,097.00	-	96,097.00	96,097.00
55	DST - J.C. Bose Fellowship	14,53,292.00	-	14,53,292.00	8,04,759.00	6,48,533.00	14,53,292.00
56	SSB - PKK-CSIR	-	1,50,000.00	1,50,000.00	1,50,000.00	-	-
57	PRL - Planex CH2	4,98,994.00	-	4,98,994.00	-	4,98,994.00	4,98,994.00
58	DCFS-PhD	-	24,64,000.00	24,64,000.00	13,43,102.00	11,20,898.00	-
59	ERC-IPR	-	60,00,000.00	60,00,000.00	60,00,000.00	-	-
60	FCIPT-STAS	2,47,234.00	-	2,47,234.00	1,06,157.00	1,41,077.00	2,47,234.00
61	FCIPT-TATA Steel	49,677.00	9,44,275.00	9,93,952.00	9,93,952.00	-	49,677.00
62	FCIPT-BRNS	(1,10,430.00)	17,01,437.00	15,91,007.00	15,28,540.00	62,467.00	(1,10,430.00)
63	FCIPT-IIT-TM	(1,74,100.00)	4,50,000.00	2,75,900.00	3,697.00	2,72,203.00	(1,74,100.00)
64	FCIPT-WRA	38,018.00	-	38,018.00	38,018.00	-	38,018.00
65	FCIPT-NIT	84,203.00	-	84,203.00	64,124.00	20,079.00	84,203.00
66	FCIPT-DST-IPT	4,90,260.00	-	4,90,260.00	34,903.00	4,55,357.00	4,90,260.00
67	FCIPT-BPCL	6,43,003.00	7,11,900.00	13,54,903.00	8,58,643.00	4,96,260.00	6,43,003.00
68	FCIPT-SPIX-II	72,22,345.00	25,10,585.00	97,32,930.00	69,15,750.00	28,17,180.00	72,22,345.00
69	FCIPT-DU-CDPS	30,03,029.00	20,00,000.00	50,03,029.00	12,41,077.00	37,61,952.00	30,03,029.00
70	FCIPT-DU-PPNS	24,45,401.00	16,50,000.00	40,95,401.00	7,84,225.00	33,11,176.00	24,45,401.00
71	FCIPT-DU-WGPS	21,35,131.00	20,00,000.00	41,35,131.00	16,54,424.00	24,80,707.00	21,35,131.00
72	FCIPT-DU-SEPS	34,85,738.00	20,00,000.00	54,85,738.00	8,50,294.00	46,35,444.00	34,85,738.00
73	FCIPT-BRFST	3,53,386.00	-	3,53,386.00	2,73,916.00	79,470.00	3,53,386.00
74	FCIPT-DST-TRITION	28,55,754.00	2,658.00	28,58,412.00	28,92,889.00	(34,477.00)	28,55,754.00
75	FCIPT-IJPS CI	2,27,589.00	-	2,27,589.00	2,27,589.00	-	2,27,589.00
76	FCIPT-RCITL-IV	-	1,90,000.00	1,90,000.00	-	1,90,000.00	-
77	FCIPT-DST-IPT-ER	9,00,000.00	3,00,000.00	12,00,000.00	4,64,409.00	7,35,591.00	9,00,000.00
78	FCIPT-DST-HIFED	21,51,376.00	-	21,51,376.00	48,637.00	21,02,739.00	21,51,376.00
79	FCIPT-CORR	14,50,000.00	-	14,50,000.00	16,40,548.00	(1,90,548.00)	14,50,000.00
80	FCIPT-EXCEL	9,53,790.00	-	9,53,790.00	83,251.00	8,70,539.00	9,53,790.00
81	FCIPT-JU-BPNS	-	2,75,000.00	2,75,000.00	1,51,268.00	1,23,732.00	-
82	FCIPT-DST-KULLU	-	24,56,000.00	24,56,000.00	7,425.00	24,48,575.00	-
83	FCIPT-DST-KH	-	23,12,000.00	23,12,000.00	29,839.00	22,82,161.00	-
84	FCIPT-DST-KU	-	3,00,000.00	3,00,000.00	30,692.00	2,69,308.00	-
85	FCIPT-SMIT	-	1,81,800.00	1,81,800.00	12,789.00	1,69,011.00	-
86	FCIPT-DST-MANTRA	-	12,00,000.00	12,00,000.00	-	12,00,000.00	-
87	FCIPT-DST-SPC	-	34,63,900.00	34,63,900.00	-	34,63,900.00	-
88	FCIPT-ADA	-	50,00,000.00	50,00,000.00	39,474.00	49,60,526.00	-
89	FCIPT-DST-PCS	-	22,61,250.00	22,61,250.00	-	22,61,250.00	-
90	DST/PAC	2,78,634.00	1,05,000.00	3,83,634.00	1,47,475.00	2,36,159.00	2,78,634.00
91	DST-SERC	2,36,105.00	-	2,36,105.00	-	2,36,105.00	2,36,105.00
92	Plasma Processing Fund	1,63,31,708.00	66,44,626.00	2,29,76,334.00	12,56,816.00	2,17,19,518.00	1,63,31,708.00
93	Dr.Parvez Guzdar Fund	-	4,78,863.00	4,78,863.00	-	4,78,863.00	-
B	CPP	-	-	-	-	-	-
	BRNS	3,25,747.00	8,135.00	3,33,882.00	71,746.00	2,62,136.00	3,25,747.00
	Untide Fund	(2,26,057.00)	15,00,000.00	12,73,943.00	5,04,599.00	7,69,344.00	(2,26,057.00)
	CSIR Project	(1,21,210.00)	-	(1,21,210.00)	-	(1,21,210.00)	(1,21,210.00)
	DST Project	-	-	-	-	-	-
C	ITER -India	-	-	-	-	-	-
	CODACTA1-ITERIO	2,77,54,635.00	3,71,76,122.00	6,49,30,757.00	1,43,85,111.00	5,05,45,646.00	2,77,54,635.00
	TA-CAD-ENG/IN	(4,84,47,328.00)	1,24,73,218.00	(3,59,74,110.00)	19,92,642.00	(3,79,66,752.00)	(4,84,47,328.00)
	ITER INDIA FUND	3,21,23,887.00	-	3,21,23,887.00	-	3,21,23,887.00	3,21,23,887.00
	TA-FEEDER	(5,81,937.00)	-	(5,81,937.00)	-	(5,81,937.00)	(5,81,937.00)
	IOSA-DPE	-	35,26,691.00	35,26,691.00	4,743.00	35,21,948.00	-
	IO-TASK-SPMC	-	-	-	23,20,822.00	(23,20,822.00)	-
	BALANCE FOR YEAR 2011-12	15,32,84,372.00	15,76,49,886.00	31,09,34,258.00	12,12,06,196.00	18,97,28,062.00	15,32,84,372.00

INSTITUTE FOR PLASMA RESEARCH**BHAT, GANDHINAGAR – 382 428**

(Sponsored by Dept. of Atomic Energy, Govt. of India, Mumbai)

Registration No. GUJ/88/GANDHINAGAR

SCHEDULES FORMING PART OF BALANCE SHEET AS AT 31ST MARCH, 2012

PARTICULARS	2011-12	2010-11
<u>SCHEDULE 4 - CURRENT LIABILITIES AND PROVISIONS:</u>		
A. <u>CURRENT LIABILITIES :</u>		
1. Sundry Creditors		
a) For Goods	40,03,570.00	73,60,761.00
b) Others	-	-
2. Other Current Liabilities		
a) Security Deposits	2,82,01,569.00	2,13,47,431.00
b) Other Liabilities	31,00,249.00	60,01,371.00
<u>TOTAL (A)</u>	<u>3,53,05,388.00</u>	<u>3,47,09,563.00</u>
B. <u>PROVISIONS</u>		
1. Gratuity	10,10,29,087.00	8,81,57,709.00
2. Superannuating/Pension	40,58,68,145.00	32,69,29,608.00
3. Accumulated Leave Encashment	9,27,43,718.00	7,75,51,560.00
4. Outstanding Expenses	97,61,826.00	1,17,61,655.00
5. Audit Fees Payable	2,76,282.00	1,93,025.00
	-	-
<u>TOTAL (B)</u>	<u>60,96,79,058.00</u>	<u>50,45,93,557.00</u>
<u>TOTAL (A+B)</u>	<u>64,49,84,446.00</u>	<u>53,93,03,120.00</u>

INSTITUTE FOR PLASMA RESEARCH
BHAT, GANDHINAGAR – 382 428
 (Sponsored by Dept. of Atomic Energy, Govt. of India, Mumbai)
 Registration No. GUJ/88/GANDHINAGAR

SCHEDULES FORMING PART OF BALANCESHEET AS AT 31ST MARCH, 2012										
SCHEDULE 5 - FIXED ASSETS										
DESCRIPTION	Consolidated Cost as at beginning of the year	Addition during the year	Ded. during the year	Cost as at the year end	Consolidated up to beginning of the year	for the year	on deductions	Total up to the year end	NET BLOCK As at the Current year end	As at the Previous year end
A. FIXED ASSETS:										
1. LAND:										
a) Freehold										
1. Bhat Land	56,75,519.00	-	-	56,75,519.00	-	-	-	-	56,75,519.00	56,75,519.00
2. GIDC Land	83,52,433.00	-	-	83,52,433.00	-	-	-	-	83,52,433.00	83,52,433.00
3. CPP Land	4,36,440.00	-	-	4,36,440.00	-	-	-	-	4,36,440.00	4,36,440.00
2. BUILDINGS:										
On Freehold Land										
a) Main Building	23,05,54,002.00	8,88,797.00	-	23,14,42,799.00	5,01,80,710.00	38,04,531.00	-	5,39,85,241.00	17,44,57,558.00	18,03,73,292.00
b) Guest House/Hostel Building	5,57,96,008.00	-	-	5,57,96,008.00	4,23,389.00	13,68,138.00	-	17,93,527.00	5,40,02,481.00	5,53,70,619.00
c) Staff quarters	28,55,711.00	-	-	28,55,711.00	12,80,070.00	46,548.00	-	13,26,618.00	5,29,093.00	15,75,641.00
d) FCPT Building	7,42,89,423.00	14,42,379.00	-	7,57,31,802.00	6,17,214.00	-	-	6,17,214.00	7,51,14,588.00	7,42,89,423.00
e) Lab. Building	2,25,02,194.00	46,04,000.00	-	2,71,06,194.00	78,10,161.00	4,92,443.00	-	83,02,604.00	1,88,03,590.00	1,46,92,033.00
f) Approach Road	-	71,695.00	-	71,695.00	-	-	-	-	71,695.00	-
	-	39,27,112.00	-	39,27,112.00	-	32,006.00	-	32,006.00	38,95,106.00	-
3. PLANT MACHINERY & EQUIPMENTS										
a) Scientific Equipments	2,96,62,63,080.00	45,98,12,981.00	28,481.00	3,42,60,47,580.00	1,04,85,70,923.00	14,56,42,718.00	22,545.00	1,19,41,91,096.00	2,31,18,56,484.00	1,91,76,92,157.00
b) Workshop Equipments	66,09,877.00	-	5,51,418.00	60,58,459.00	37,44,686.00	2,20,242.00	3,31,766.00	36,33,162.00	94,25,297.00	28,63,191.00
c) Workshop Tools	1,90,926.00	-	-	1,90,926.00	1,71,840.00	1,086.00	-	1,72,926.00	18,000.00	19,086.00
d) Machinery & Equipment	1,01,23,804.00	-	-	1,01,23,804.00	44,98,177.00	5,29,819.00	-	50,27,996.00	30,95,808.00	56,25,627.00
e) Mechanical Works Equipment	3,94,390.00	-	-	3,94,390.00	1,55,632.00	20,923.00	-	1,76,575.00	2,17,815.00	2,38,738.00
f) Vehicle	4,37,833.00	-	-	4,37,833.00	3,96,938.00	7,460.00	-	4,04,418.00	33,415.00	40,875.00
4. FURNITURE, FIXTURES	5,39,85,338.00	85,89,009.00	1,29,478.00	6,24,44,869.00	2,09,96,023.00	31,27,364.00	1,21,157.00	2,40,02,230.00	3,84,42,639.00	3,27,62,102.00
5. OFFICE GEN. EQUIPMENTS	2,09,79,929.00	1,60,06,234.00	1,27,800.00	3,68,58,563.00	1,22,94,055.00	12,80,877.00	54,248.00	1,35,20,684.00	2,33,37,679.00	89,13,088.00
6. COMPUTER / PERIPHERALS	32,04,11,933.00	5,13,55,219.00	72,14,907.00	36,45,52,244.00	20,19,02,469.00	4,37,26,084.00	67,97,378.00	23,88,31,175.00	11,57,21,069.00	11,85,09,464.00
7. ELECTRIC INSTALLATION	1,34,93,552.00	7,08,652.00	-	1,42,02,204.00	69,20,293.00	3,54,631.00	-	72,74,924.00	99,27,280.00	65,73,259.00
8. LIBRARY BOOKS / JOURNALS	15,68,73,693.00	1,44,49,198.00	1,11,380.00	17,12,11,511.00	6,64,11,553.00	68,77,135.00	36,171.00	7,32,52,517.00	9,79,58,994.00	9,04,62,140.00
TOTAL FOR CURRENT YEAR	3,95,02,26,085.00	56,18,55,276.00	81,63,464.00	4,50,39,17,897.00	1,42,57,58,959.00	20,81,49,219.00	73,63,265.00	1,62,65,44,913.00	2,87,73,72,983.00	2,52,44,67,127.00
PREVIOUS YEAR	3,55,39,26,435.00	40,38,90,607.00	75,90,957.00	3,95,02,26,085.00	1,25,03,09,155.00	18,24,79,507.00	70,29,704.00	1,42,57,58,958.00	3,13,04,130.00	2,83,33,22,720.00
B. CAPITAL WORK-IN-PROGRESS	30,88,55,593.00	27,77,30,140.00	21,35,41,603.00	37,30,44,130.00	1,42,57,58,959.00	20,81,49,219.00	38,00,07,395.00	1,62,65,44,913.00	3,22,04,17,113.00	3,22,04,17,113.00
TOTAL	4,25,90,81,678.00	83,95,85,416.00	22,17,05,067.00	4,87,69,62,027.00	1,42,57,58,959.00	20,81,49,219.00	38,00,07,395.00	1,62,65,44,913.00	3,22,04,17,113.00	3,22,04,17,113.00

INSTITUTE FOR PLASMA RESEARCH
BHAT, GANDHINAGAR – 382 428
(Sponsored by Dept. of Atomic Energy, Govt. of India, Mumbai)
Registration No. GUJ/88/GANDHINAGAR

SCHEDULES FORMING PART OF BALANCE SHEET AS AT 31ST MARCH, 2012		
PARTICULARS	2011-2012	2010-11
SCHEDULE 6 - CURRENT ASSETS, LOANS, ADVANCES ETC:		
A. CURRENT ASSETS :		
<u>1. Inventories:</u>		
a) Stores and spares	67,47,259.00	71,55,567.00
<u>2. Cash balances in hand (including cheques/drafts and imprest)</u>		
IPR	92,777.00	67,910.00
ITER-India	59,405.00	45,829.00
CPP	2,443.00	758.00
<u>3. Bank Balances:</u>		
<u>a) With Scheduled Banks:</u>		
- On Current Accounts		
State Bank of India, IPR Branch, Gandhinagar (IPR)	3,47,63,724.00	4,07,89,078.00
State Bank of India, Naroda Branch, Ahmedabad (IPR)	3,05,00,138.00	1,24,93,317.00
State Bank of India, IPR Branch, Gandhinagar (ITER-India)	24,51,073.00	4,00,84,905.00
State Bank of India, Naroda Branch, Ahmedabad (ITER-India)	24,71,120.00	1,03,00,220.00
State Bank of India, Sonapur, Guwahati (CPP-IPR)	91,07,761.00	1,79,27,248.00
State Bank of India, CPP, Guwahati	23,89,857.00	73,13,148.00
State Bank of India, PRF, Guwahati	32,50,712.00	31,29,621.00
- On Deposit Accounts		
State Bank of India -(IPR)	1,10,33,03,953.00	82,76,36,366.00
State Bank of India - (ITER-India)	2,75,25,50,489.00	1,79,32,67,513.00
State Bank of India - (CPP-IPR)	50,00,000.00	-
- On Savings Accounts		
State Bank of India,S.B.No 30767137485	5,25,12,963.00	69,65,934.00
<u>TOTAL (A)</u>	4,00,52,03,674.00	2,76,71,77,414.00
B. LOANS, ADVANCES AND OTHER ASSETS :		
<u>1. Loans:</u>		
a) Staff		
House Building Advance (Including accrued interest)	2,65,96,356.00	2,77,19,271.00
Computer Advance (Including accrued interest)	1,15,40,992.00	1,14,85,444.00
Vehicle Advance (Including accrued interest)	55,99,469.00	57,82,496.00
<u>2. Advances and amounts recoverable in cash or in kind or for value to be received:</u>		
a) Advances to Non Govt. Contractors & Suppliers (Including adv. for Capital Works)	1,11,58,74,673.00	62,36,42,052.00
b) Advances to Govt. Institutions/Organisations (Refer Note 5 of Schedule-14)	78,74,84,315.00	68,61,18,441.00
c) Deposit with Government Authorities	63,09,473.00	63,09,473.00
d) Deposit with Others	37,94,093.00	37,43,093.00
d) Telephone Recovery	905.00	1,112.00
e) TDS	12,32,480.00	10,04,957.00
f) Advance for Travelling Expenses	2,90,84,408.00	1,51,74,885.00
g) General Advance	4,64,364.00	3,18,164.00
h) Festival Advance	53,700.00	46,620.00
i) LTC Advance	16,55,194.00	6,58,154.00
j) Medical Recovery	16,784.00	1,115.00
k) CPP-NPS	-	1,55,662.00
l) Prepaid Expenses	17,39,219.00	-
<u>3. Income Accrued:</u>		
a) On Bank Fixed Deposits	4,20,66,710.00	3,38,04,017.00
<u>TOTAL (B)</u>	2,03,35,13,135.00	1,41,59,64,956.00
<u>TOTAL (A+B)</u>	6,03,87,16,809.00	4,18,31,42,370.00

INSTITUTE FOR PLASMA RESEARCH
BHAT, GANDHINAGAR – 382 428
(Sponsored by Dept. of Atomic Energy, Govt. of India, Mumbai)
Registration No. GUJ/88/GANDHINAGAR

SCHEDULES FORMING PART OF INCOME & EXPENDITURE FOR THE YEAR ENDED 31 ST MARCH, 2012

PARTICULARS	2011-12	2010-11
SCHEDULE 7 - GRANTS/SUBSIDIES :		
(Irrevocable Grants & Subsidies Received)		
1) Central Government (Dept. of Atomic Energy, Govt. of India)	4,51,64,00,000.00	3,82,63,00,000.00
TOTAL	4,51,64,00,000.00	3,82,63,00,000.00
SCHEDULE 8 - INTEREST EARNED :		
1) On Term Deposits & Savings Deposits:		
a) With Scheduled Banks	19,74,28,818.00	7,62,16,113.00
2) On Loans:		
a) Employees/Staff		
- On Vehicle Advance	3,19,389.00	3,16,099.00
- On Computer Advance	6,50,688.00	6,58,660.00
- On House Building Advance	12,23,104.00	12,20,675.00
TOTAL	19,96,21,999.00	7,84,11,547.00
SCHEDULE 9 - OTHER INCOME :		
1) Miscellaneous Income	2,09,050.00	2,06,695.00
2) Rent	1,63,411.00	81,047.00
3) Royalty & Transfer Fee Income	10,52,235.00	41,55,532.00
TOTAL	14,24,696.00	44,43,274.00

INSTITUTE FOR PLASMA RESEARCH
BHAT, GANDHINAGAR – 382 428
(Sponsored by Dept. of Atomic Energy, Govt. of India, Mumbai)
Registration No. GUJ/88/GANDHINAGAR

SCHEDULES FORMING PART OF INCOME & EXPENDITURE FOR THE YEAR 31ST MARCH, 2012

PARTICULARS	2011-12	2010-11
SCHEDULE 10 - ESTABLISHMENT EXPENSES :		
a) Salaries and Wages	22,13,34,136.00	23,70,32,643.00
b) Allowances and Bonus	19,60,20,556.00	14,92,14,344.00
c) Contribution to Provident Fund	1,51,40,022.00	1,20,72,559.00
d) Staff Welfare Expenses	2,85,166.00	2,19,545.00
e) Expenses on Employees' Retirement and Terminal Benefits	10,87,75,824.00	14,16,69,182.00
f) NPS charges	1,13,963.00	1,17,872.00
Less: PF Contribution Receipt for PF Trust on Option change CPF to GPF	(1,02,44,635.00)	(2,05,47,497.00)
TOTAL	53,14,25,032.00	51,97,78,648.00
SCHEDULE 11 - OTHER ADMINISTRATIVE EXPENSES ETC. :		
a) Purchases- Consumable Stores & Spares	15,18,79,441.00	16,56,21,276.00
b) Electricity and Power	4,49,63,527.00	5,67,94,372.00
c) Repairs and Maintenance	5,28,69,730.00	4,12,10,860.00
d) Rent, Rates and taxes	1,35,42,759.00	1,27,36,684.00
e) Transport Hire Charges	1,81,98,159.00	1,65,77,238.00
f) Postage & Telegraph	5,73,715.00	5,61,940.00
g) Telephone and Trunk	49,33,002.00	35,82,342.00
h) Printing and Stationary	20,37,913.00	17,53,215.00
i) Travelling and conveyance Expenses	1,70,04,337.00	1,31,04,795.00
j) Travelling Expenses-International	3,62,40,594.00	2,93,24,068.00
k) T.A. to Candidates	5,54,762.00	2,51,010.00
l) Expenses on Seminar/Workshops	34,83,711.00	29,31,648.00
m) Membership	76,979.00	38,303.00
n) Auditors Remuneration - Internal	1,57,892.00	82,725.00
o) Auditors Remuneration - Statutory	1,40,450.00	1,10,300.00
p) Entertainment Expenses	15,22,998.00	10,71,814.00
q) Professional/Legal Charges	6,12,814.00	5,67,324.00
r) Security Expenses	95,28,885.00	78,02,924.00
s) Freight and Cartage Expenses	13,08,240.00	12,84,987.00
t) Visiting Scientist Expenses	17,69,696.00	25,99,983.00
u) Advertisement and Publicity	60,94,509.00	56,06,524.00
v) Others- Misc. Expenses	2,82,837.00	89,028.00
w) Book Grant to Research Student	7,86,894.00	86,408.00
x) Short term Research Programme	6,79,086.00	1,84,508.00
y) Honorarium	4,60,482.00	2,77,256.00
z) Medical Expenses	87,90,687.00	71,20,146.00
aa) Leverages	7,712.00	1,00,236.00
ab) Bank Charges	5,84,582.00	18,75,855.00
ac) Cylinder Hire Charges	1,06,322.00	93,064.00
ad) Wages	1,62,97,412.00	1,06,79,778.00
ae) Canteen Subsidy	17,64,997.00	17,06,838.00
af) Printing & Publication	6,46,608.00	12,55,143.00
ag) Collaborative Research Expenses	79,18,722.00	5,10,50,619.00
ah) Technical & Professional Consultancy	14,60,35,387.00	3,02,27,243.00
ai) Forest Royalty	-	-
TOTAL	55,18,55,841.00	46,83,60,454.00

**INSTITUTE FOR PLASMA RESEARCH
BHAT, GANDHINAGAR – 382 428**

(Sponsored by Dept. of Atomic Energy, Govt. of India, Mumbai)
Registration No. GUJ/88/GANDHINAGAR

SCHEDULES FORMING PART OF INCOME & EXPENDITURE FOR THE YEAR 31ST MARCH, 2012

PARTICULARS	2011-12	2010-11
SCHEDULE 12 - DEPRECIATION:		
a) Building	38,04,531.00	37,19,900.00
b) Staff Quarters Building	46,548.00	46,548.00
c) Scientific Equipments	14,56,42,718.00	13,11,40,536.00
d) Workshop Equipments	2,20,242.00	2,46,736.00
e) Workshop Tools	1,086.00	1,271.00
f) Furniture & Fixture	31,27,364.00	27,51,123.00
g) Office/General Equipments	12,80,877.00	4,97,605.00
h) Computers/Peripherals	4,37,26,084.00	3,62,91,613.00
i) Electric Installations	3,54,631.00	2,70,236.00
j) Library Books/Journals	68,74,236.00	64,15,751.00
k) Guest House Building	13,68,138.00	50,278.00
l) Lab Building	4,92,443.00	4,89,683.00
M) Machinery & Equipment	5,29,819.00	5,29,819.00
N) Mechanical Works	20,923.00	20,923.00
O) Vehicle	7,460.00	7,485.00
P) FCIPT Building	6,17,214.00	-
Q) Approach Road	32,006.00	-
TOTAL	20,81,46,320.00	18,24,79,507.00

INSTITUTE FOR PLASMA RESEARCH
BHAT, GANDHINAGAR – 382 428
(Sponsored by Dept. of Atomic Energy, Govt. of India, Mumbai)
Registration No. GUJ/88/GANDHINAGAR

SIGNIFICANT ACCOUNTING POLICIES

SCHEDULE- 13:

1. BASIS FOR PREPARATION OF ACCOUNTS

The Financial statements are prepared on the historical cost convention, and on accrual method of Accounting, unless otherwise stated and on going concern basis.

2. INVENTORY VALUATION

Stores & spares are valued at the weighted average cost.

3. INVESTMENT

Investments are valued at cost.

4. FIXED ASSETS

Fixed Assets are recorded at cost which includes incidental expenses incurred up to the date of commissioning of assets.

5. DEPRECIATION

- i) Depreciation is provided on Straight Line Basis at the rates specified in Schedule XIV of Companies Act, 1956.
- ii) Depreciation on additions to Assets other than Buildings and Library Books/Journals is provided on prorata basis from the month of addition.
- iii) Depreciation on additions to Buildings and Library Books/Journals is provided at 50% of the applicable rate.

6. GOVERNMENT GRANTS

Government Grants are accounted for on the basis of the Income Approach on receipt basis. Grants received in respect of Fixed Assets are transferred to the Corpus Fund through the Income & Expenditure Account at the time of acquisition of Fixed Assets.

7. FOREIGN CURRENCY TRANSACTION

- i) Foreign currency transactions during the year are recorded at rates of exchange prevailing on the date of transactions.
- ii) Foreign Currency Assets and Liabilities are not translated into rupees at the rates of exchange prevailing on Balance-Sheet date.

Contd.

INSTITUTE FOR PLASMA RESEARCH
BHAT, GANDHINAGAR – 382 428
(Sponsored by Dept. of Atomic Energy, Govt. of India, Mumbai)
Registration No. GUJ/88/GANDHINAGAR

8. CONTRIBUTIONS TO PROJECTS

Contributions to collaborative projects are accounted on the basis of the respective project agreements/Project Memorandum of Understanding.

9. RESEARCH & DEVELOPMENT

Revenue expenditure on research and development is charged against the grant of the year in which it incurred, Capital expenditure on research and development is shown as an addition to fixed assets.

10. RETIREMENT BENEFITS

Liability for all Retirement benefits like Pension, Gratuity, Leave Encashment are accounted for on actuarial valuation basis.

As per our report of even date attached.

For T.N.Shah & Co.,
Chartered Accountants

-Sd-
(Prof. P.K.Kaw)
Director

-Sd-
(Prof.R.Jha)
Dean

-Sd-
(H.K.Sharma)
Accounts Officer-I

-Sd-
(Tushar N. Shah)
Partner
Membership No. 042748

Place : Gandhinagar
Dated :31/07/2012

INSTITUTE FOR PLASMA RESEARCH
BHAT, GANDHINAGAR – 382 428
 (Sponsored by Dept. of Atomic Energy, Govt. of India, Mumbai)
 Registration No. GUJ/88/GANDHINAGAR

NOTES TO THE ACCOUNTS

SCHEDULE-14:

- 1 a** Hitherto, as per rules of ITER India Empowered Board, separate set of accounts & records were to be maintained and separate Audited Statement of Accounts were to be presented for the ITER-India Project w.e.f. April 1, 2008. Accordingly, a control account maintained for ITER-India was shown under Schedule-2 "Reserve & Surplus" for the previous year. However, in terms of Department Atomic Energy directive vide their letter No. 18/1/2010-R&D-II/9309 dated October 5, 2010, Audited Statements of Accounts for ITER-India project are to be presented on branch accounting concept. Accordingly, the necessary effects to account for the above directive of Department have been made as on March 31, 2012.
- b** The Central Government vide its letter No. 19/01/2006 - R&D - II /VOL.II /52 dated May 29, 2009 has approved administrative and Financial merger of Centre of Plasma Physics, Guwahati (CPP and CPP-IPR since May 29, 2009) with Institute for Plasma Research, Gandhinagar on as is where is basis with immediate effect. Accordingly liabilities and current assets of CPP as on May 28, 2009 are taken over at their book value and fixed assets are taken over at their net written down values as on May 28, 2009. Necessary changes are made in the Accounting Policies of CPP-IPR for period May 29, 2009 onwards. As a part of the above merger, the Government of Assam has funded certain financial obligations (including certain Contingent liabilities) of CPP-IPR outstanding as on March 31, 2008 aggregating to Rs. 72,92,204.00. Out of this, for the above merger have been made in the Statements of Accounts of CPP-IPR. Rs. 38,40,063.00 & Rs. 61,107/- paid during the during the Financial Year 2010-2011 & 2011-12 respectively.
- c** Vide its letter No. STE.89/2006/173 Dated December 17, 2008, The Government of Assam has funded certain financial obligations (including certain Contingent liabilities) of CPP outstanding as on March 31, 2008 aggregating to Rs. 72,92,204.00. Out of this, Rs. 38,40,063.00 & Rs. 61,107/- paid during the the Financial Year 2010-2011 & 2011-12 respectively. Outstanding Amount included a cost escalation claim of the Building Contractor amounting to Rs. 24,98,250.00 under consideration and subject to approval by CPP-IPR as on date. Pending Finalization of this claim, the amount received there against from the Government of Assam is shown under Current Liabilities.
- d** Considering the effects of Notes 1a, 1b & 1c above, previous year's figures may not be comparable with those of the current year. Otherwise, previous years figures have been regrouped, rearranged and reclassified wherever necessary.

2 CONTINGENT LIABILITIES :

- (i) Contingent Liabilities in respect of claims not acknowledged as debts Rs.--NIL-- (Previous year Rs. NIL).
- (ii) Guarantees and Letter of Credits given by Bank Rs. 22388.42 Lakhs (Previous Year Rs. 1893.40 Lakhs).

3 CAPITAL COMMITMENTS

Estimated value of Contracts remaining to be executed on Capital Account and not provided for Rs. 29,374.03 Lacs (Previous Year Rs. 30622.50 Lacs).

4 DEPRECIATION

Depreciation for the year 2011-2012 Rs. 20,81,46,320/- (Previous Year Rs. 18,24,79,507.26) has been debited to the Income & Expenditure Account and the like amount has been transferred from the Corpus Fund to the Income & Expenditure Account.

5 FOREIGN CURRENCY TRANSACTION

<u>i) Value of Imports Calculated on F.O.B. Basis :</u>	2011-12	2010-11
- Capital Goods	15,07,52,500.00	7,48,18,649.00
- Consumables & Spares	6,54,15,309.00	4,88,10,811.00
<u>ii) Expenditure in foreign currency :</u>		
- Travel	1,89,90,116.00	2,71,33,600.00
- Cash Contribution to ITER-Organisation	1,24,95,29,636.00	1,09,56,90,363.00
- Technical Consultancy	3,92,38,041.00	-
<u>iii) Earnings :</u>		
- Value of Exports on F.O.B. basis	Nil	Nil

INSTITUTE FOR PLASMA RESEARCH
BHAT, GANDHINAGAR – 382 428
(Sponsored by Dept. of Atomic Energy, Govt. of India, Mumbai)
Registration No. GUJ/88/GANDHINAGAR

- 6 Advance to Contractors & Suppliers (including Advance for Capital Works) stated in Schedule- 6 B includes
- a An amount of Rs. 16.55 Crore (Previous year Rs.16.55 Crore) has been paid to Indira Gandhi Centre for Advance Atomic Research for collaborative research on Development of ITER Test Blanket Modules.
- b An amount of Rs.53.00 Crore (Previous year Rs. 43.00 Crore) has been paid to Bhabha Atomic Research Centre for collaborative research on Development of ITER Test Blanket Modules.
- 7 In respect of Imports of Assets & Stores, Foreign exchange differences are treated as part of landed cost. Foreign Currency Assets & Liabilities are not revalued at exchange rates prevailing as on Balance-Sheet date.
- 8 One reactor for approx. Rs. 8.00 Lacs (Rupees 8 Lacs) included in present value of Assets is lost. No provision is made for loss.
- 9 No Insurance Policy is taken for the Movable & Immovable assets as per the usual practice.
- 10 Balances of Suppliers/Contractors are subject to confirmations & adjustment, if any.

As per our report of even date attached.

For T.N.Shah & Co.
Chartered Accountants

-Sd-
(Prof. P.K. Kaw)
Director

-Sd-
(Prof.R.Jha)
Dean

-Sd-
(H.K.Sharma)
Accounts Officer-I

-Sd-
(Tushar N. Shah)
Partner
Membership No. 042748

Place : Gandhinagar
Dated :31/07/2012